

MAT=4331 ACE FILE PRODUCED AT NEA WITH NDEC
Principal cross sections

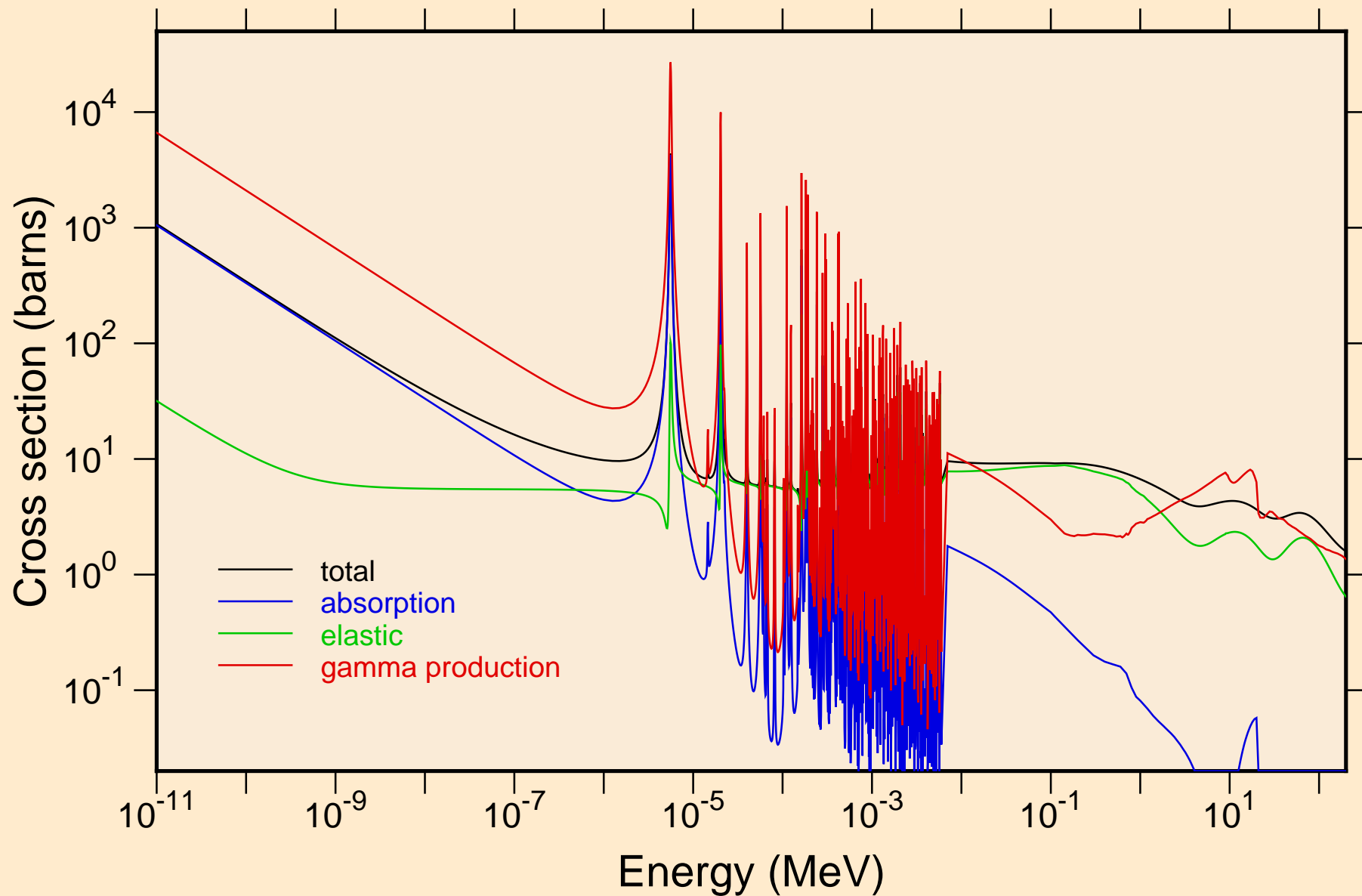

MAT=4331 ACE FILE PRODUCED AT NEA WITH NDEC
resonance total cross section

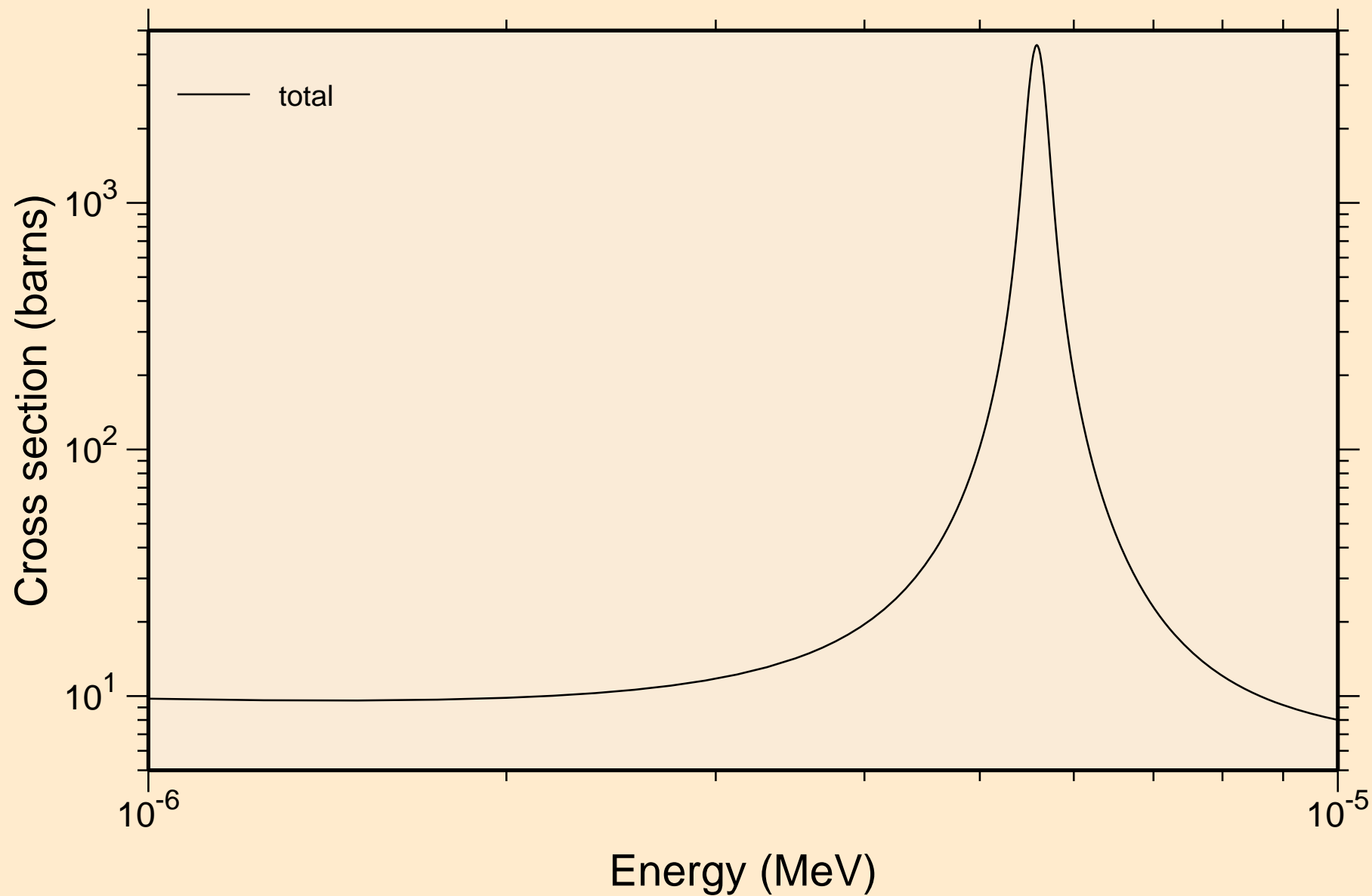

MAT=4331 ACE FILE PRODUCED AT NEA WITH NDEC
resonance total cross section

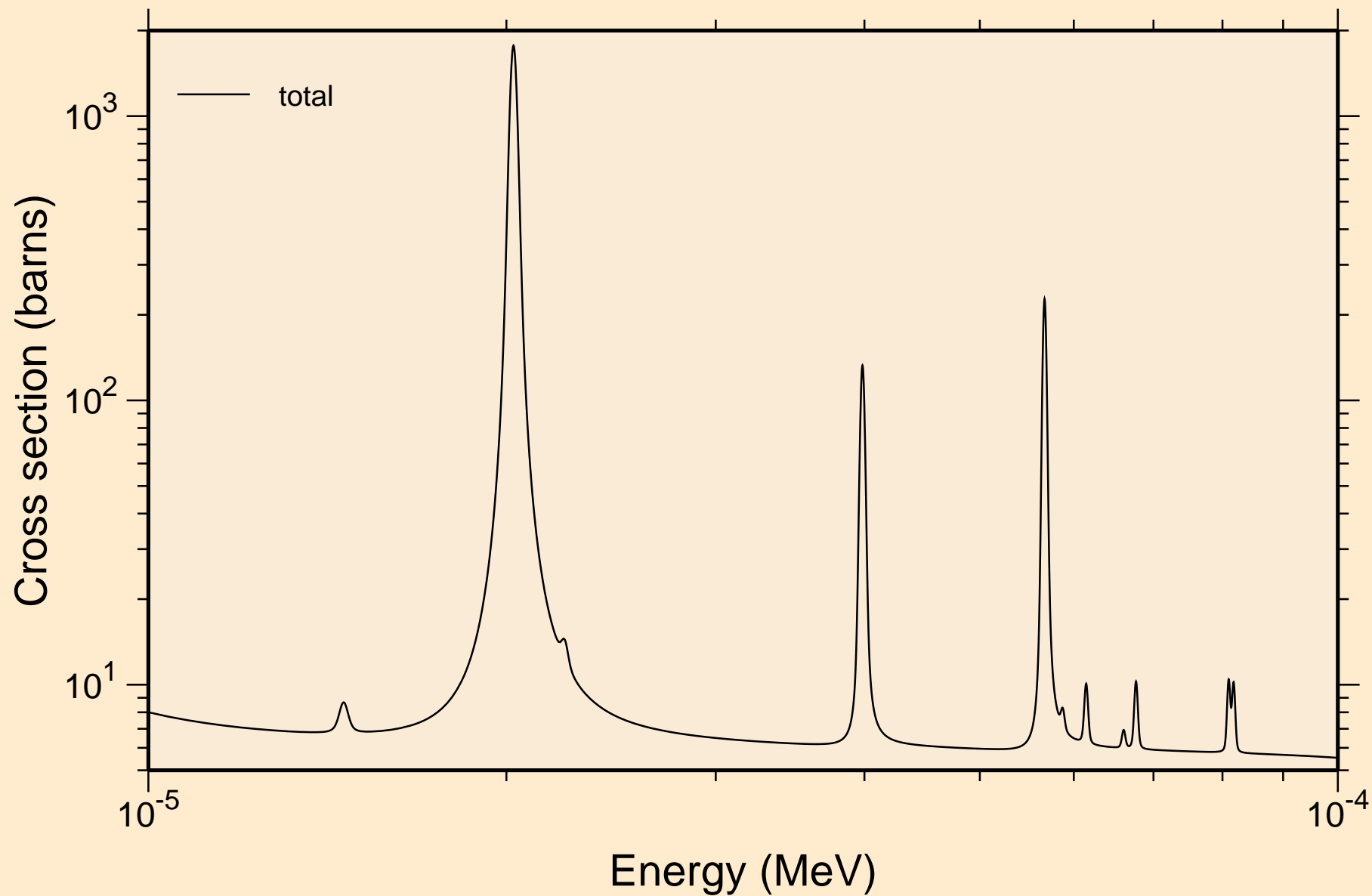

MAT=4331 ACE FILE PRODUCED AT NEA WITH NDEC
resonance total cross section

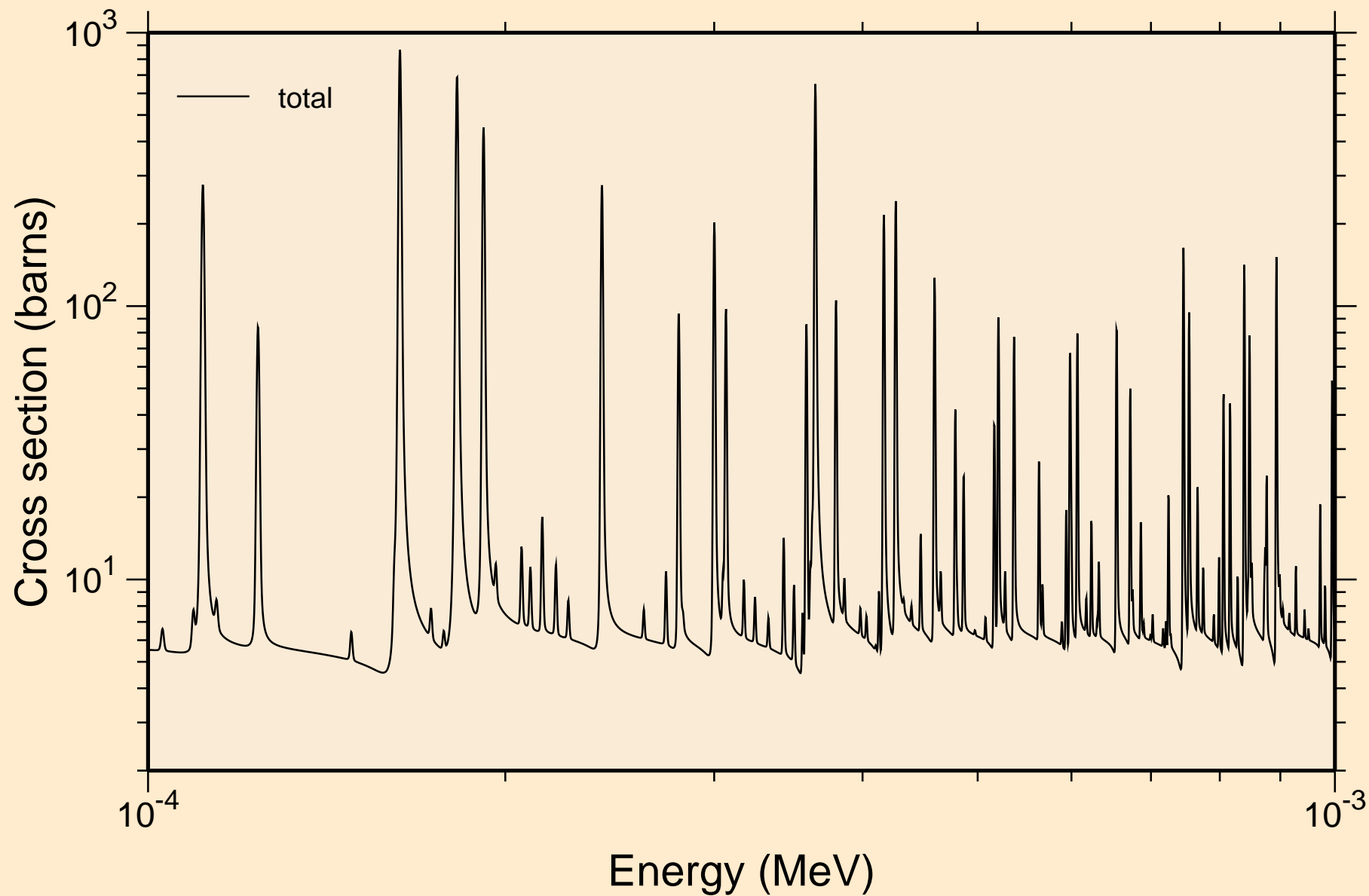

MAT=4331 ACE FILE PRODUCED AT NEA WITH NDEC
resonance total cross section

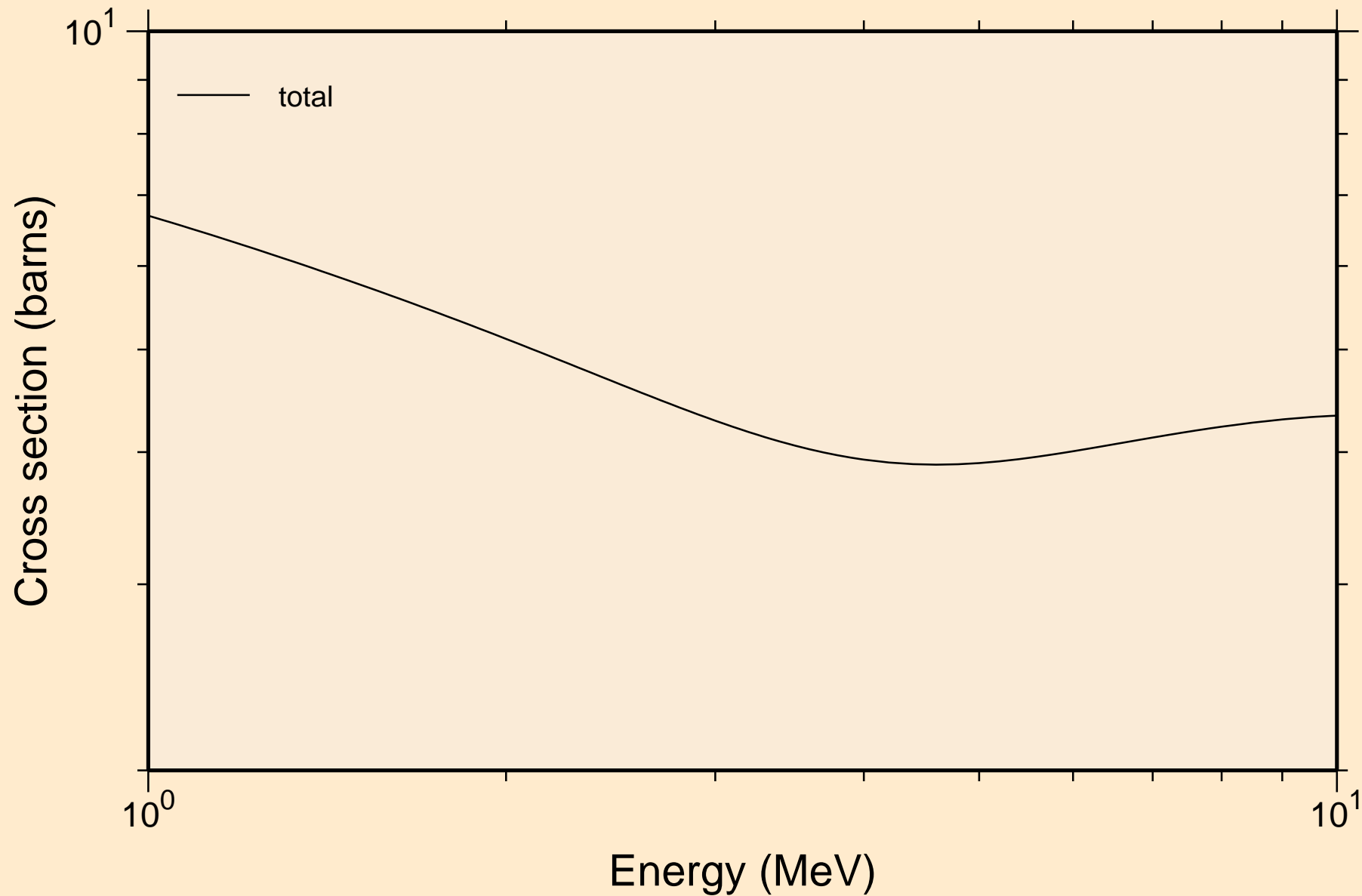

MAT=4331 ACE FILE PRODUCED AT NEA WITH NDEC
resonance absorption cross sections

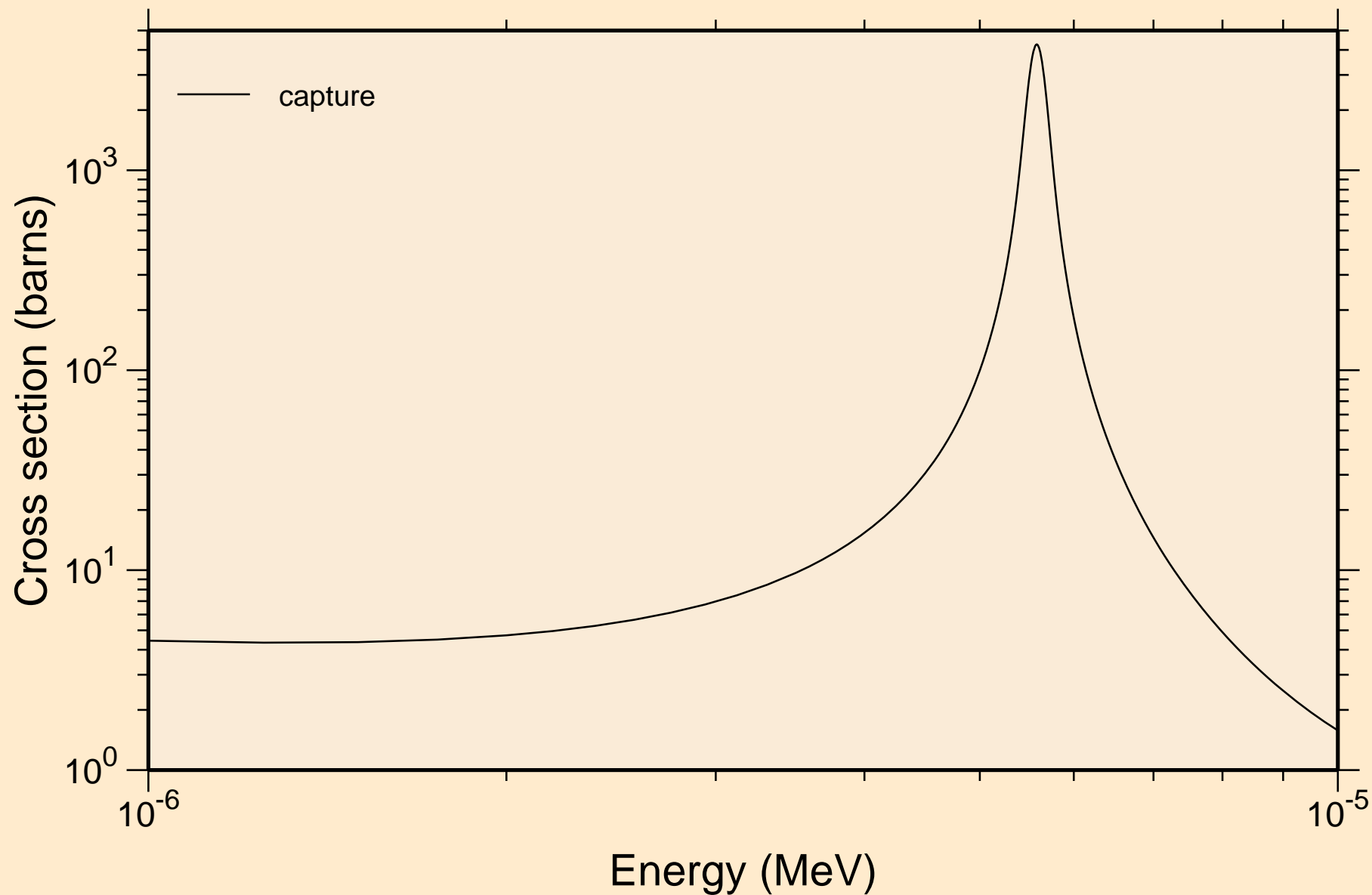

MAT=4331 ACE FILE PRODUCED AT NEA WITH NDEC
resonance absorption cross sections

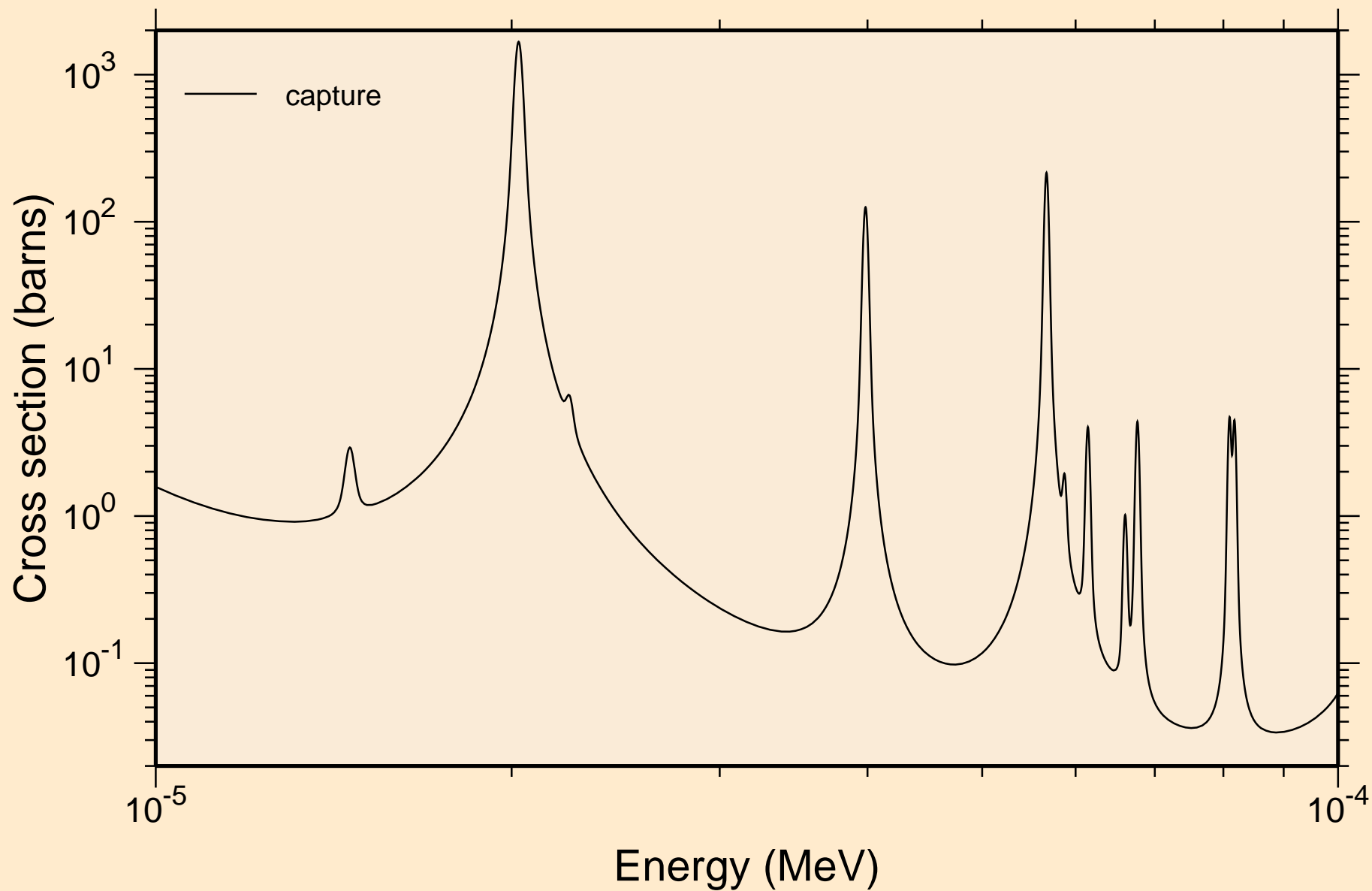

MAT=4331 ACE FILE PRODUCED AT NEA WITH NDEC
resonance absorption cross sections

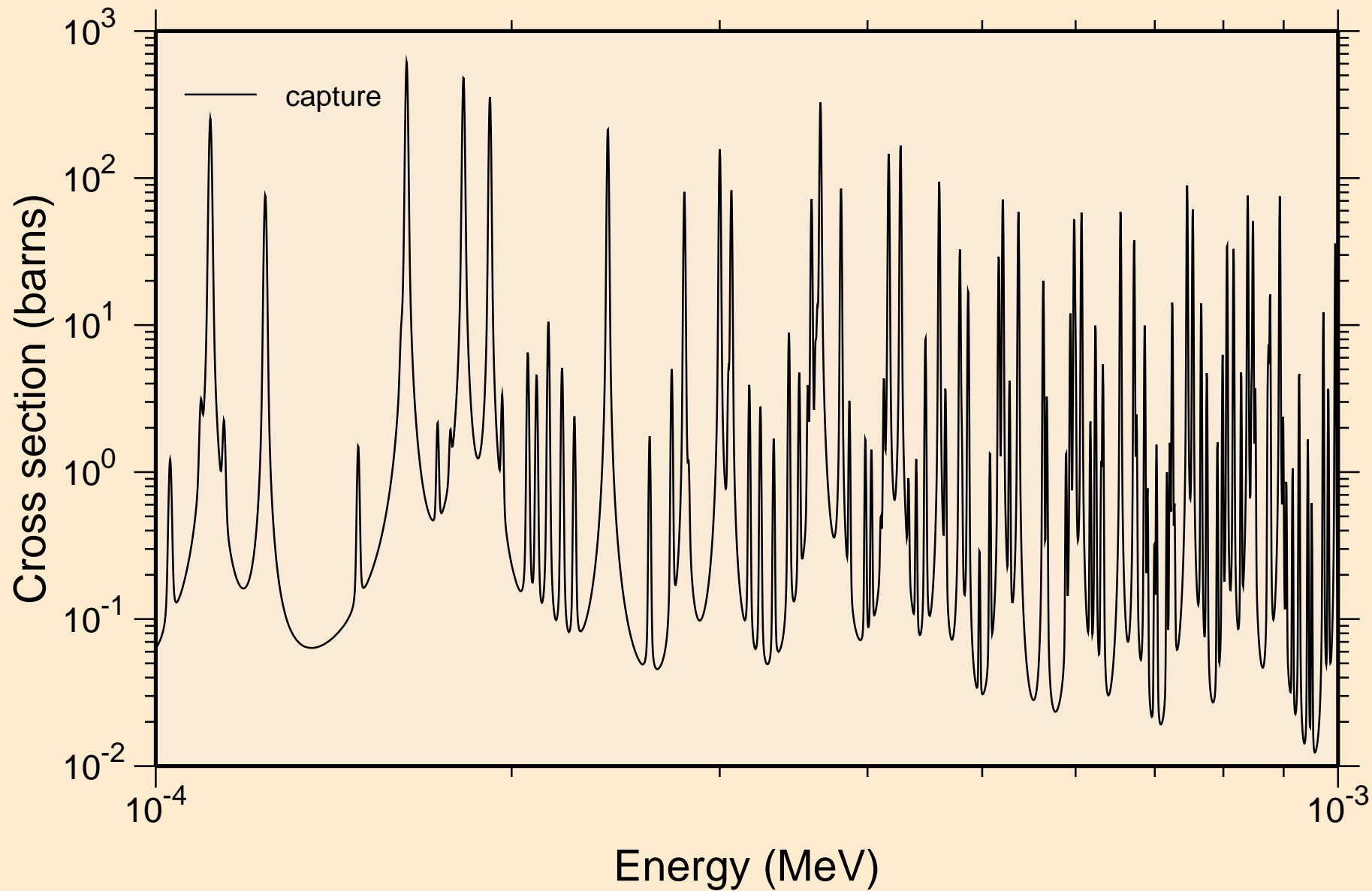

MAT=4331 ACE FILE PRODUCED AT NEA WITH NDEC
resonance absorption cross sections

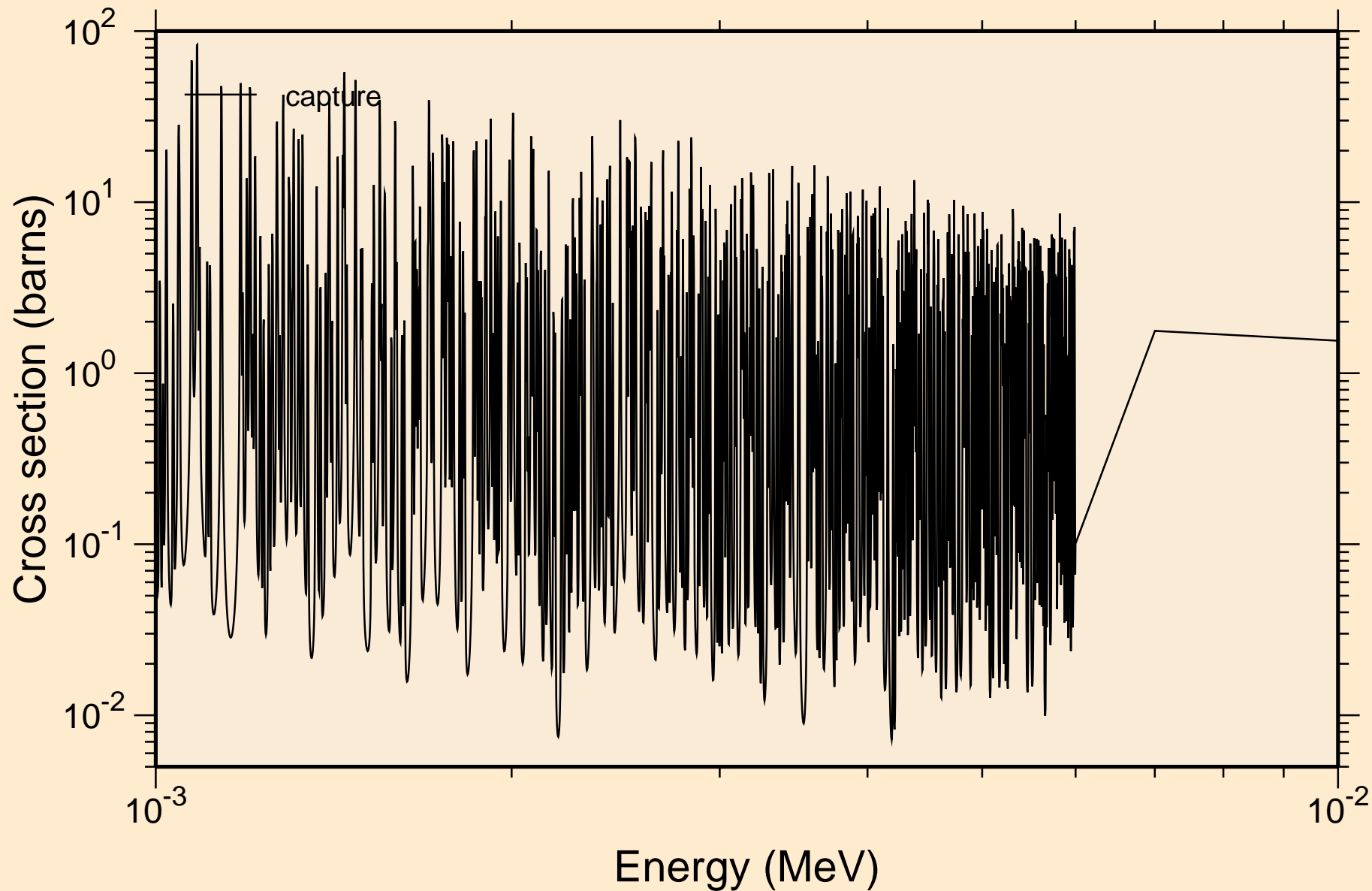

MAT=4331 ACE FILE PRODUCED AT NEA WITH NDEC
resonance absorption cross sections

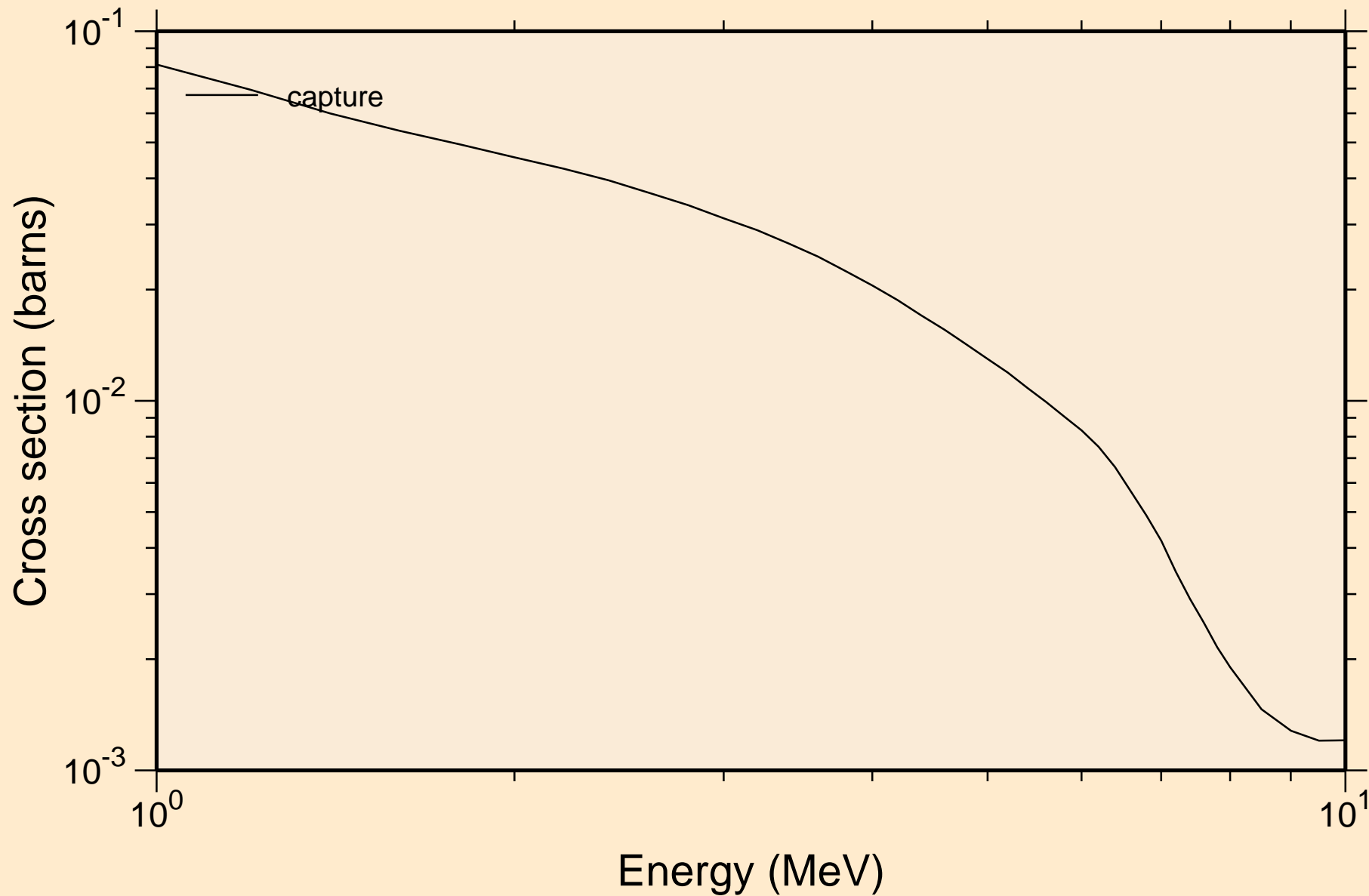

MAT=4331 ACE FILE PRODUCED AT NEA WITH NDEC
UR total cross section

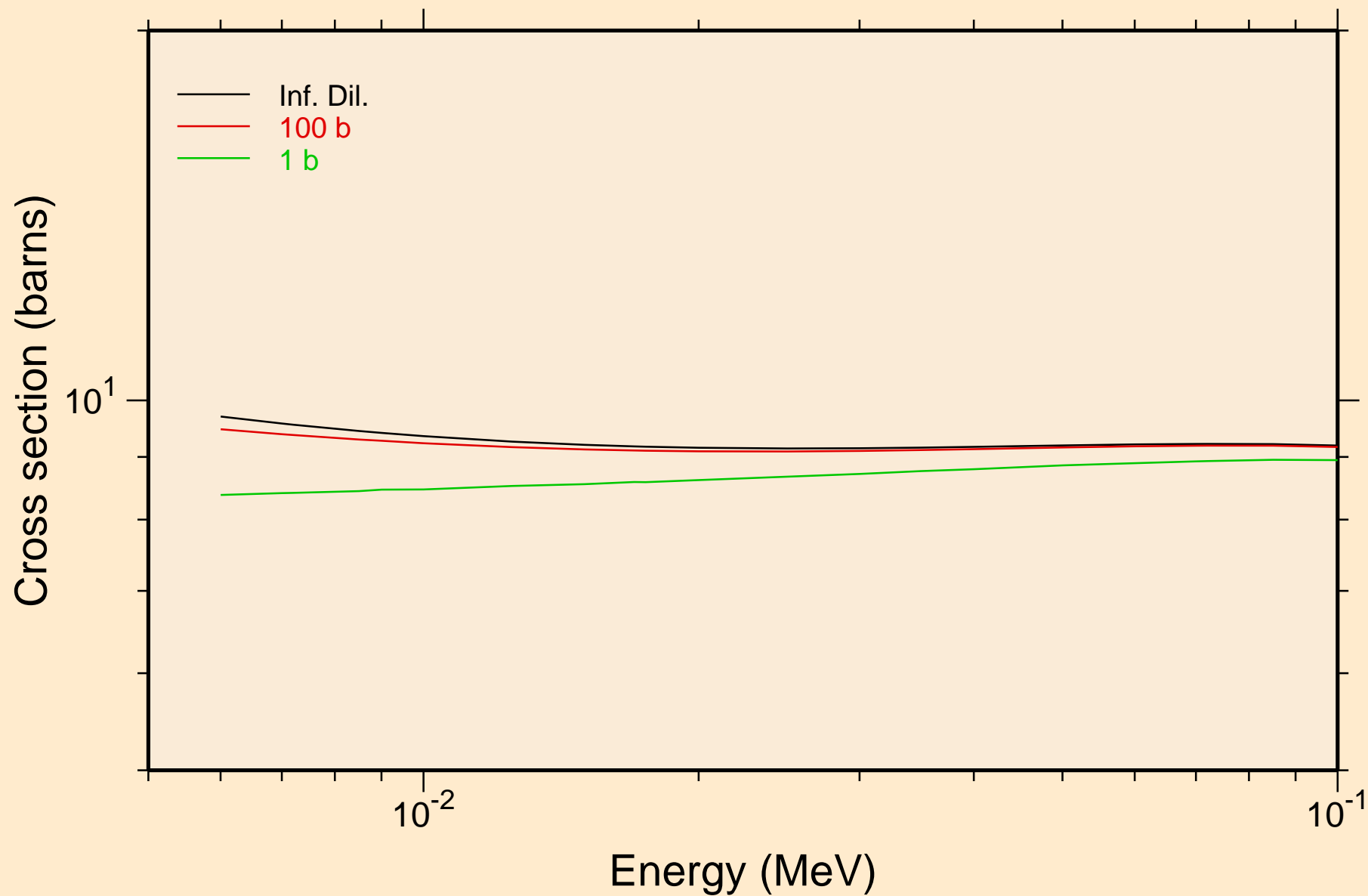

MAT=4331 ACE FILE PRODUCED AT NEA WITH NDEC
UR elastic cross section

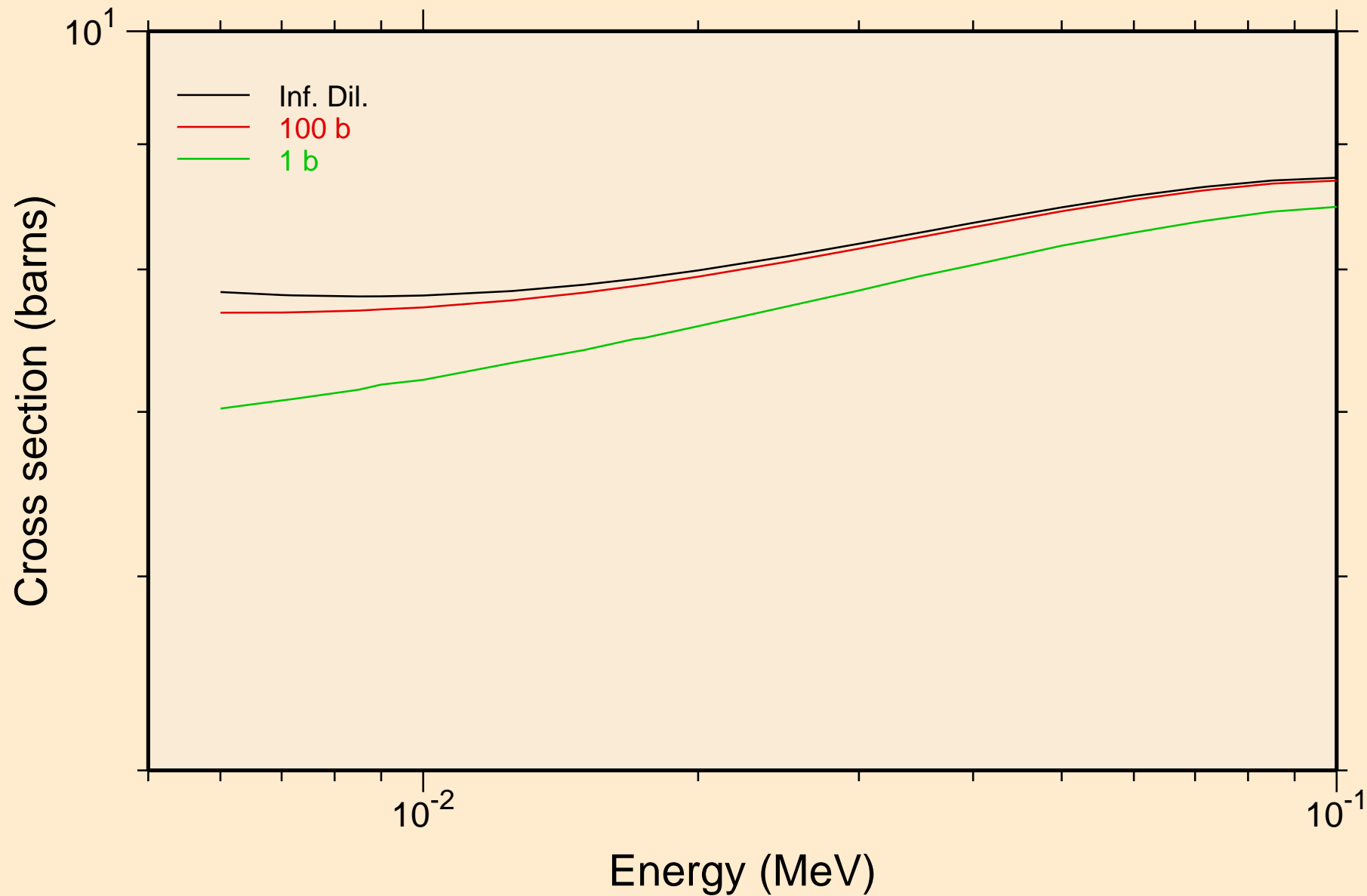

MAT=4331 ACE FILE PRODUCED AT NEA WITH NDEC
UR capture cross section

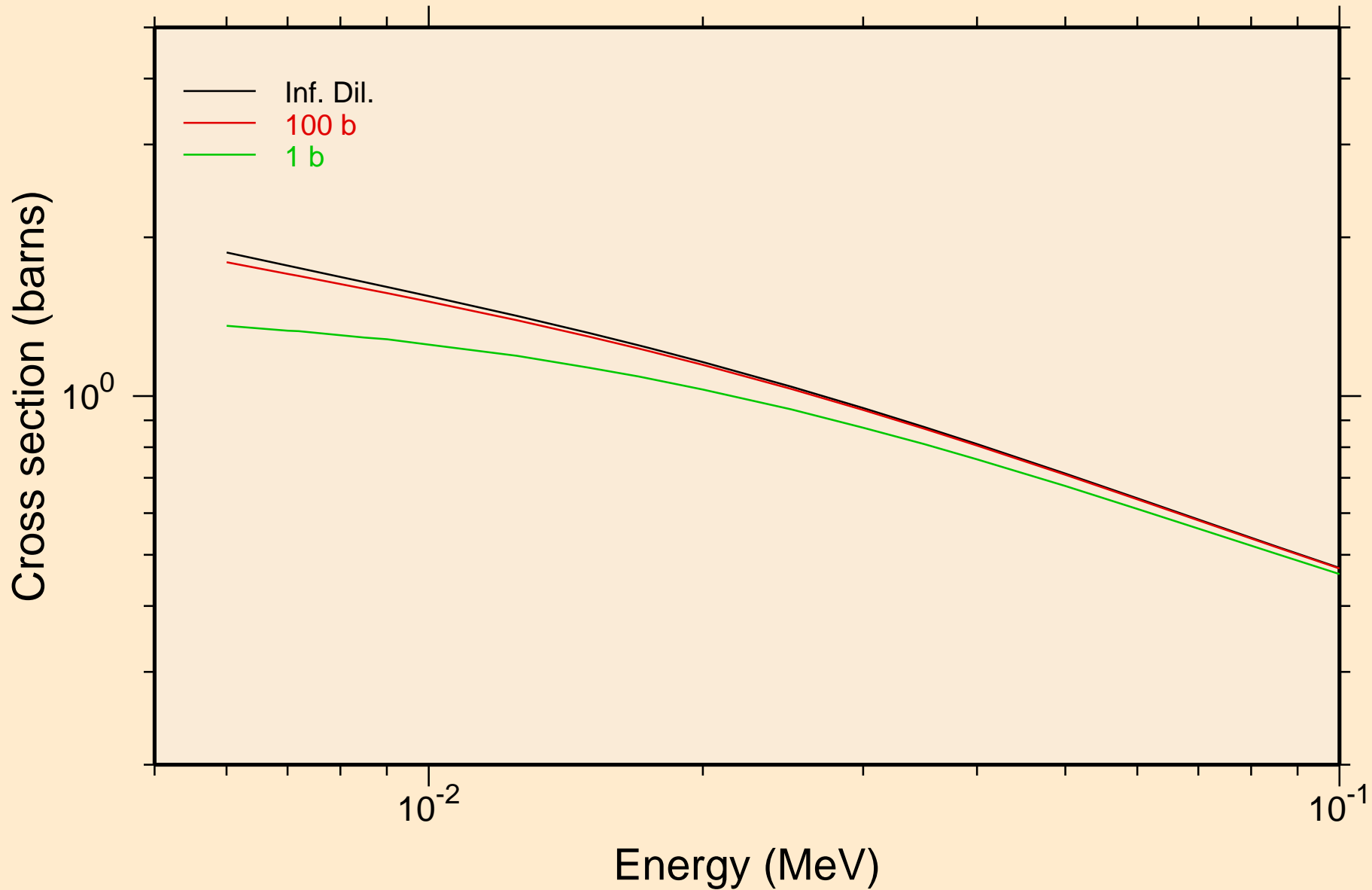

MAT=4331 ACE FILE PRODUCED AT NEA WITH NDEC
Heating

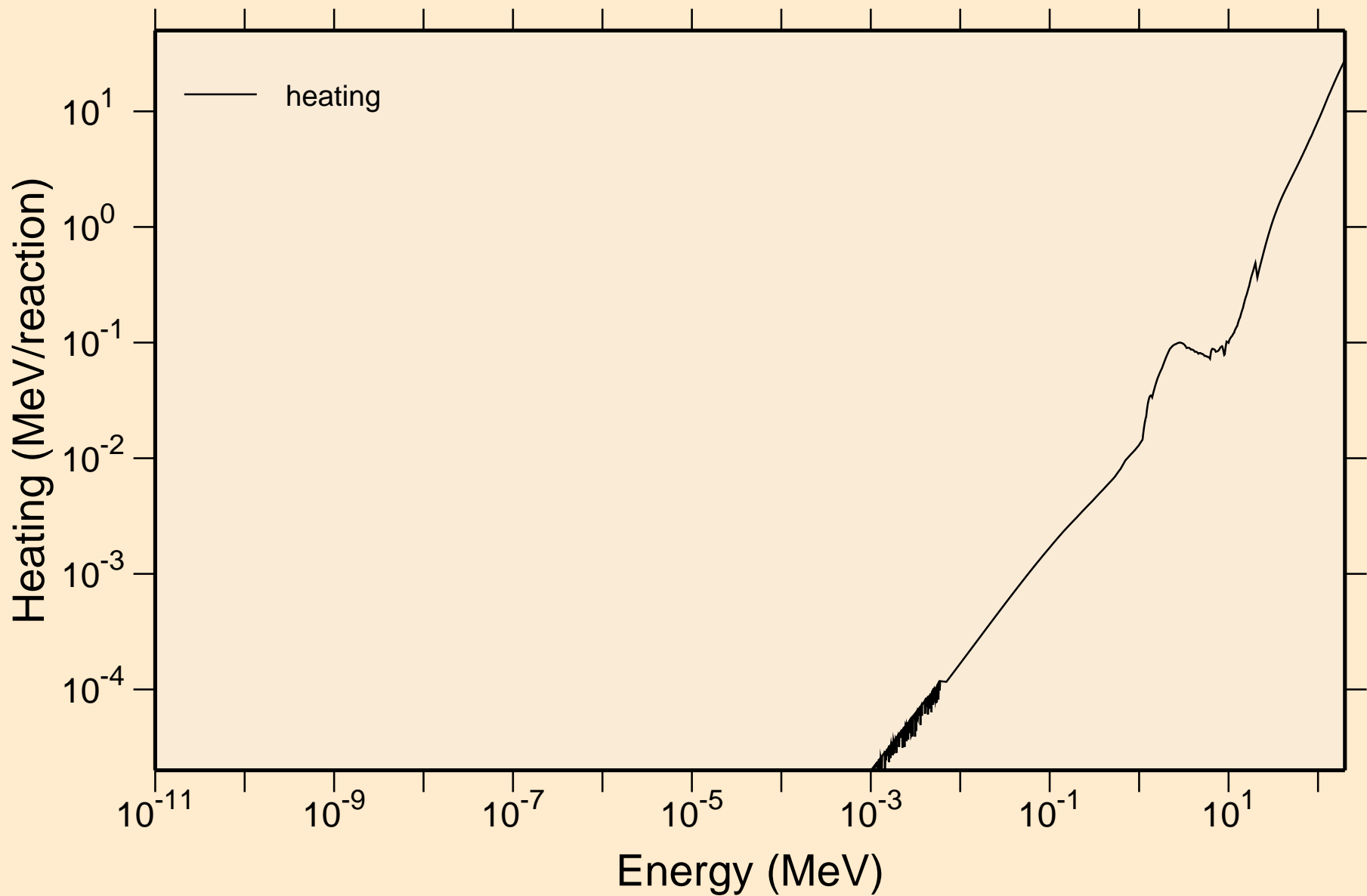

MAT=4331 ACE FILE PRODUCED AT NEA WITH NDEC
Damage

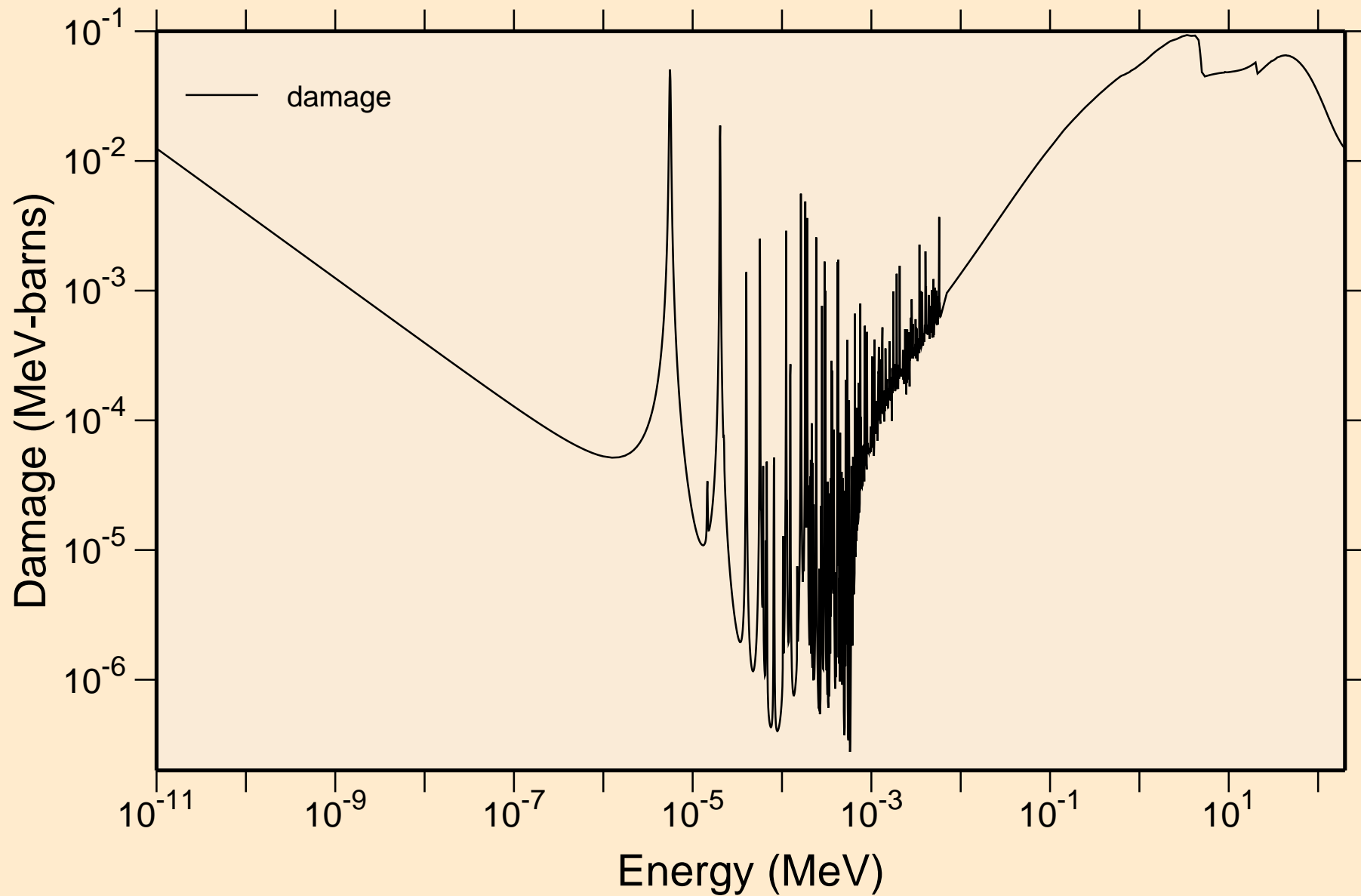

MAT=4331 ACE FILE PRODUCED AT NEA WITH NDEC
Non-threshold reactions

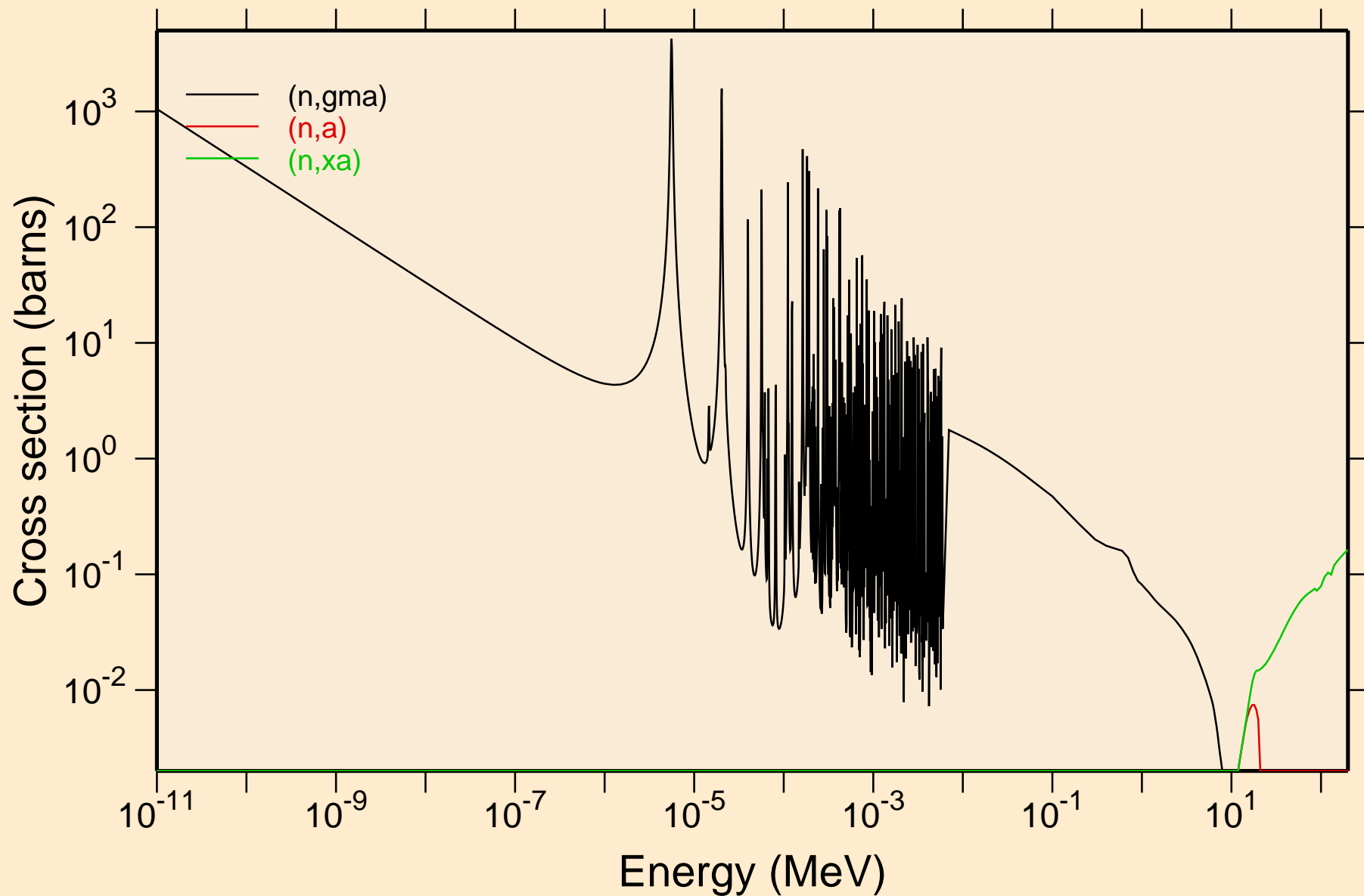

MAT=4331 ACE FILE PRODUCED AT NEA WITH NDEC

Principal cross sections

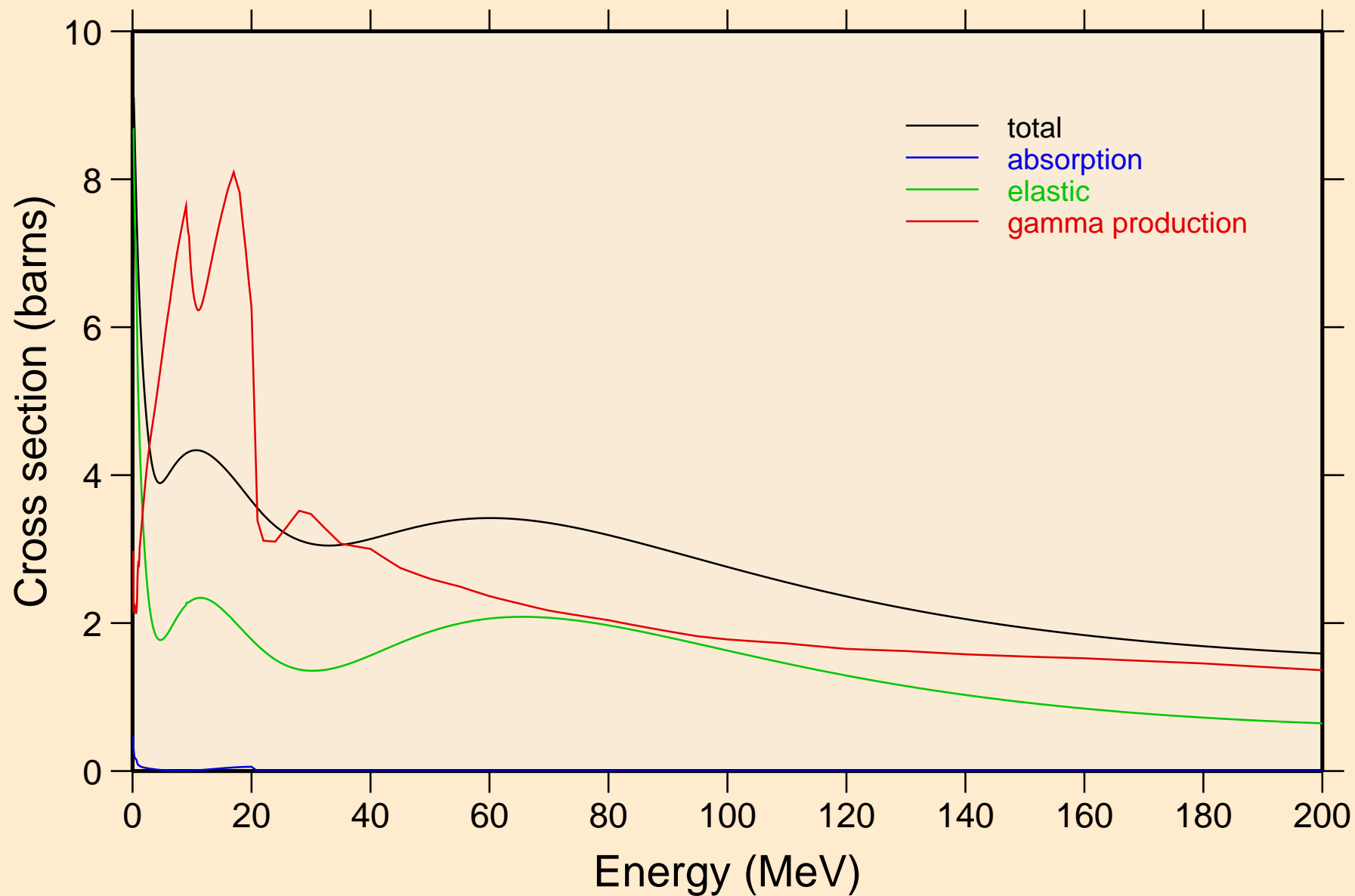

MAT=4331 ACE FILE PRODUCED AT NEA WITH NDEC
Heating

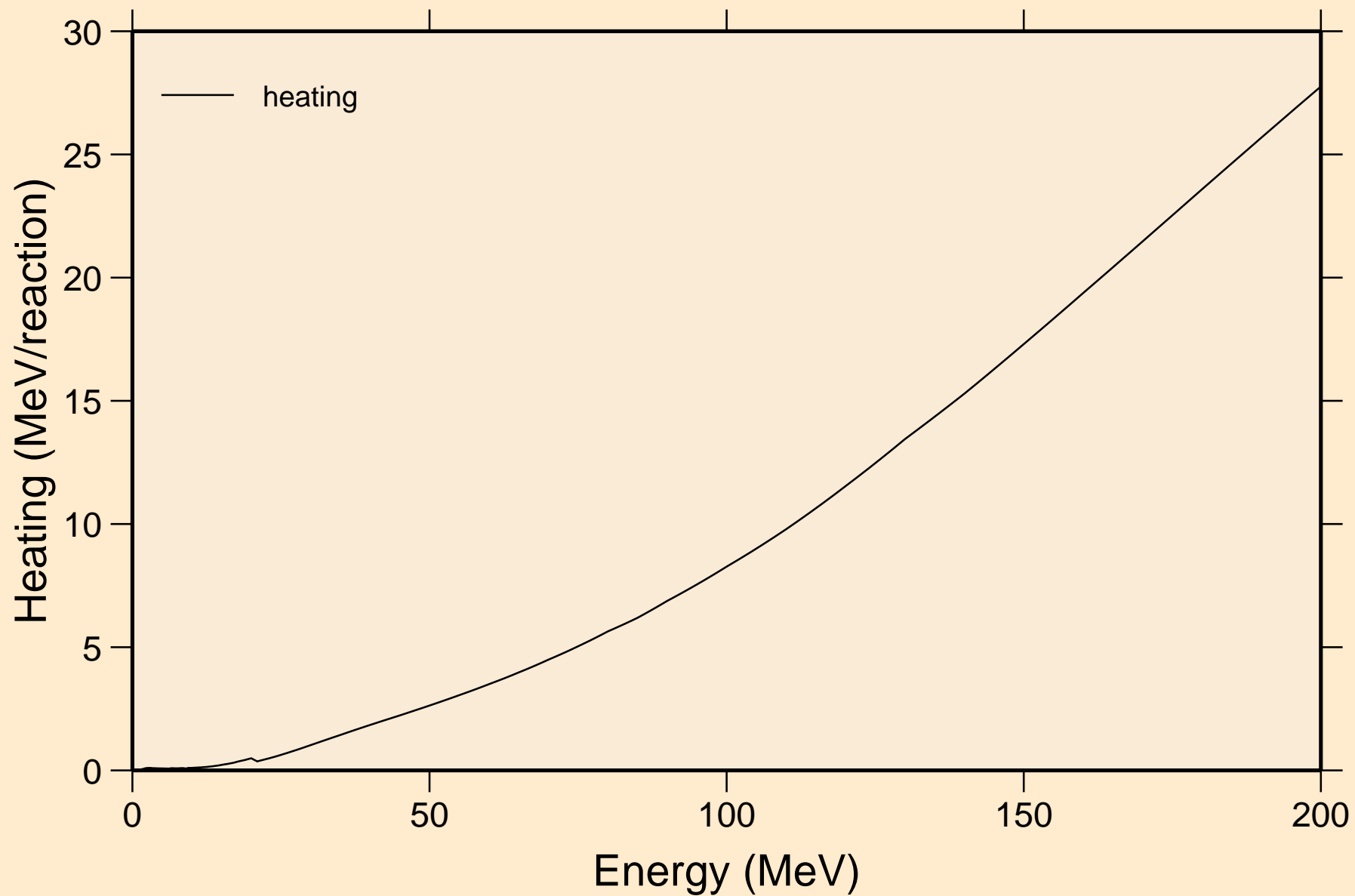

MAT=4331 ACE FILE PRODUCED AT NEA WITH NDEC
Damage

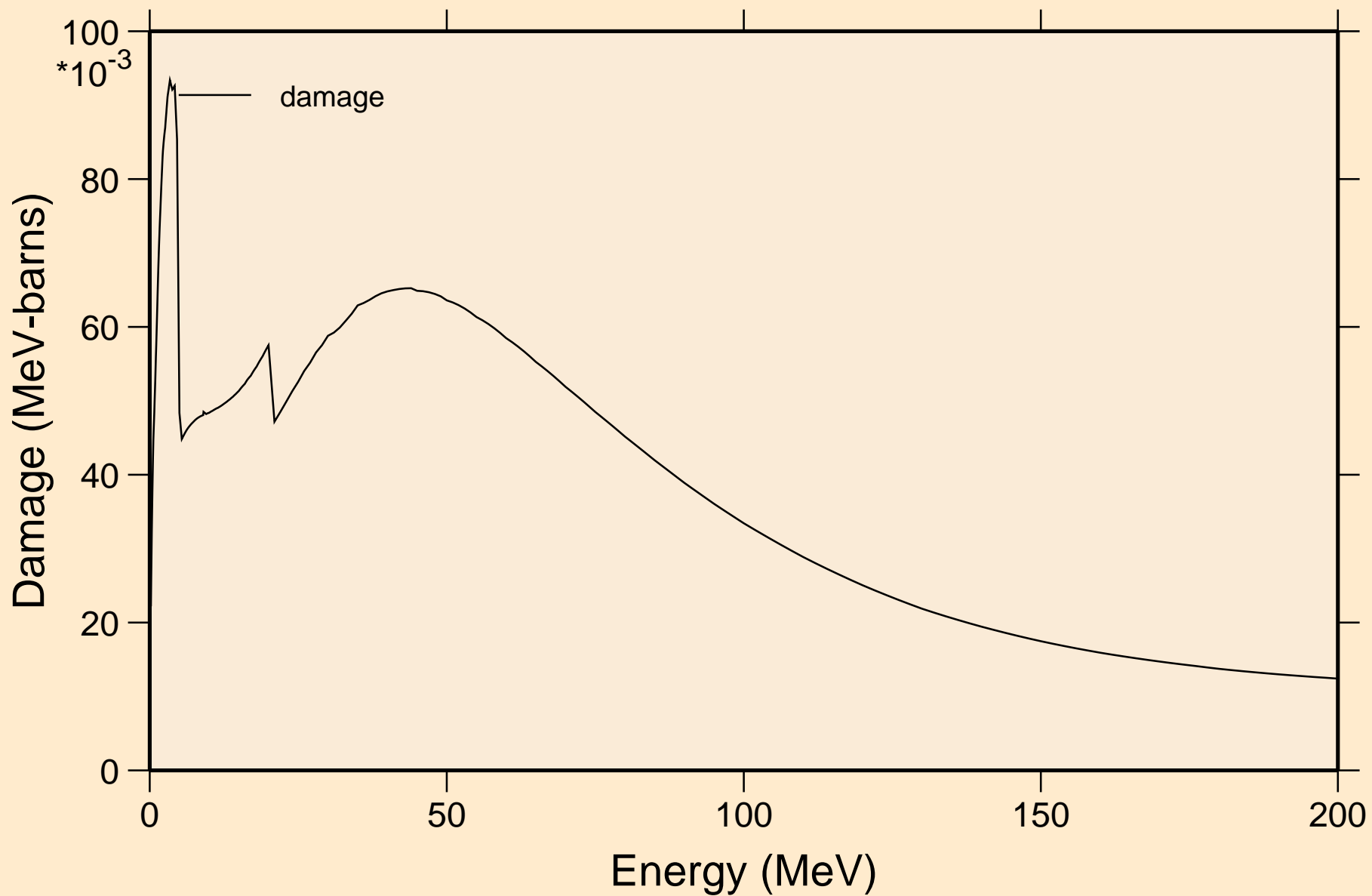

MAT=4331 ACE FILE PRODUCED AT NEA WITH NDEC
Non-threshold reactions

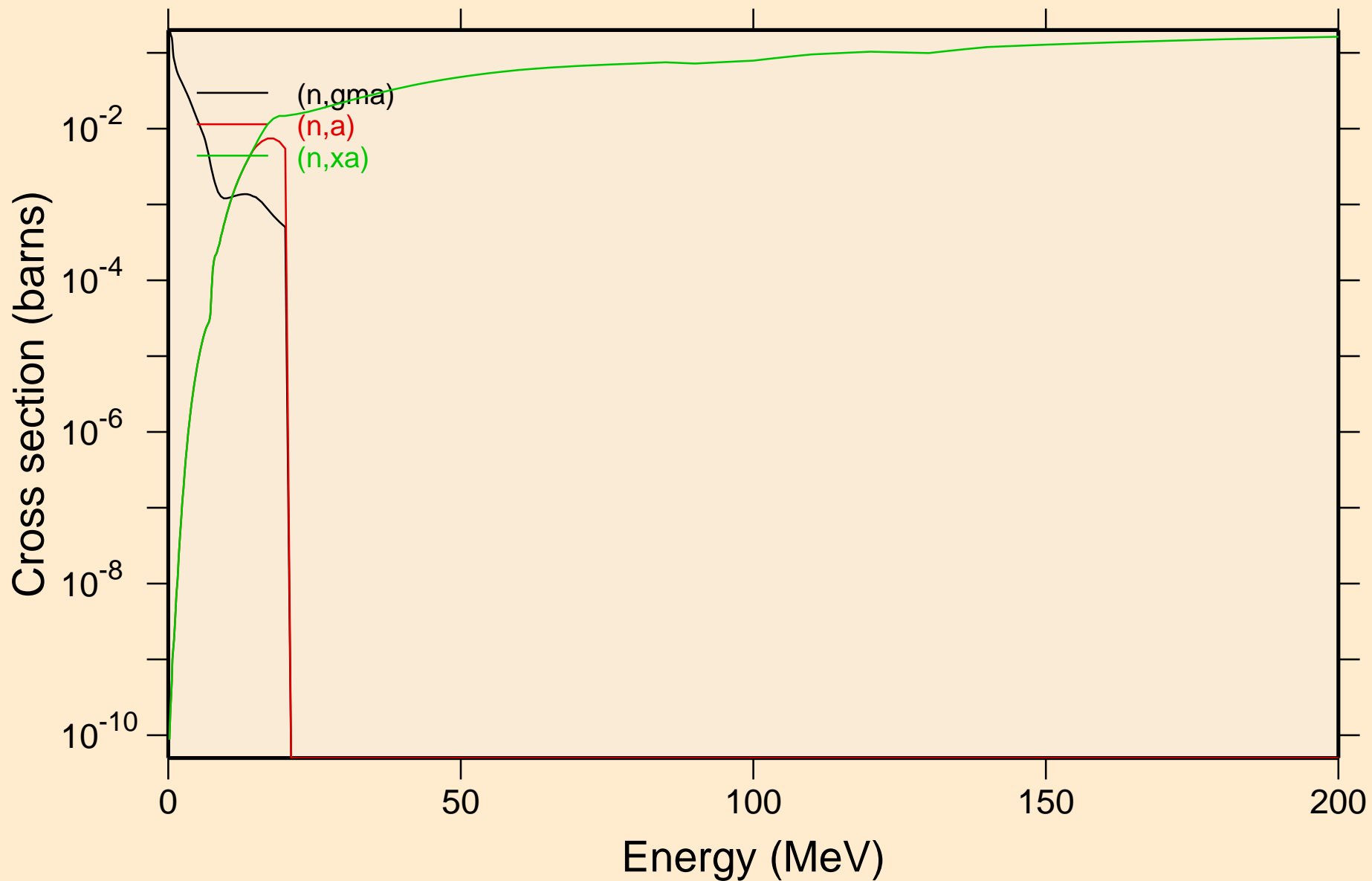

MAT=4331 ACE FILE PRODUCED AT NEA WITH NDEC
Inelastic levels

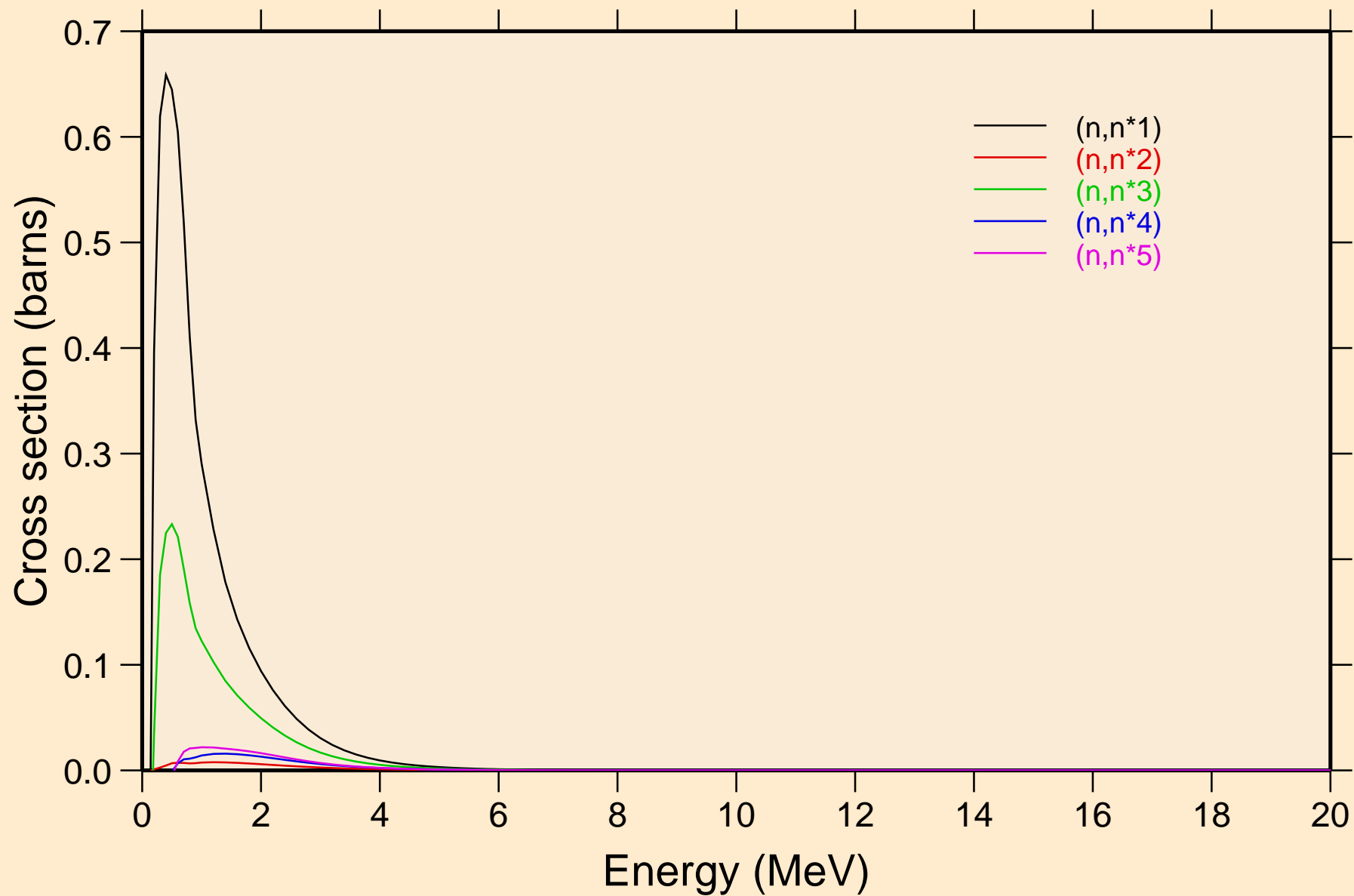

MAT=4331 ACE FILE PRODUCED AT NEA WITH NDEC
Inelastic levels

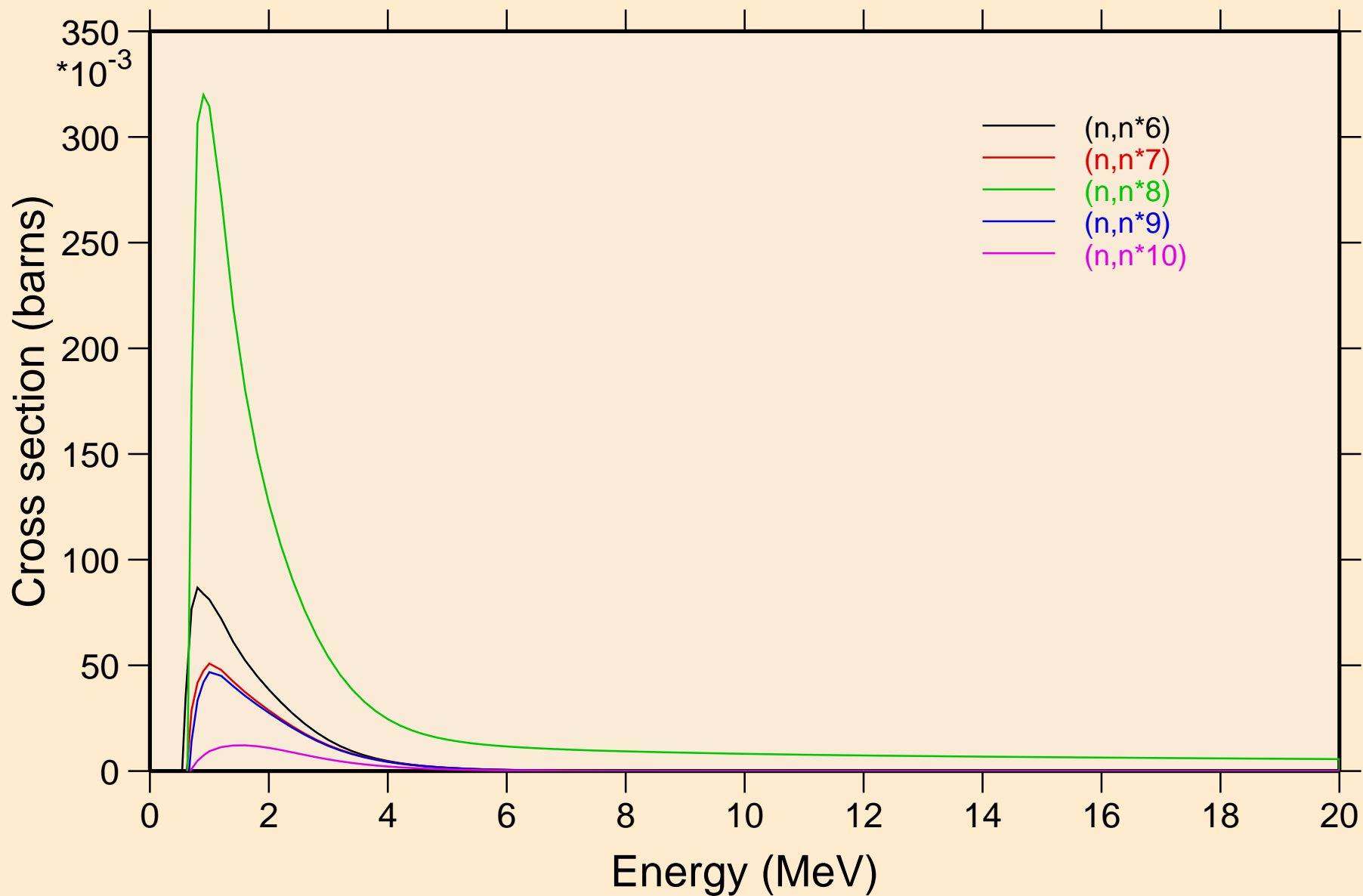

MAT=4331 ACE FILE PRODUCED AT NEA WITH NDEC
Inelastic levels

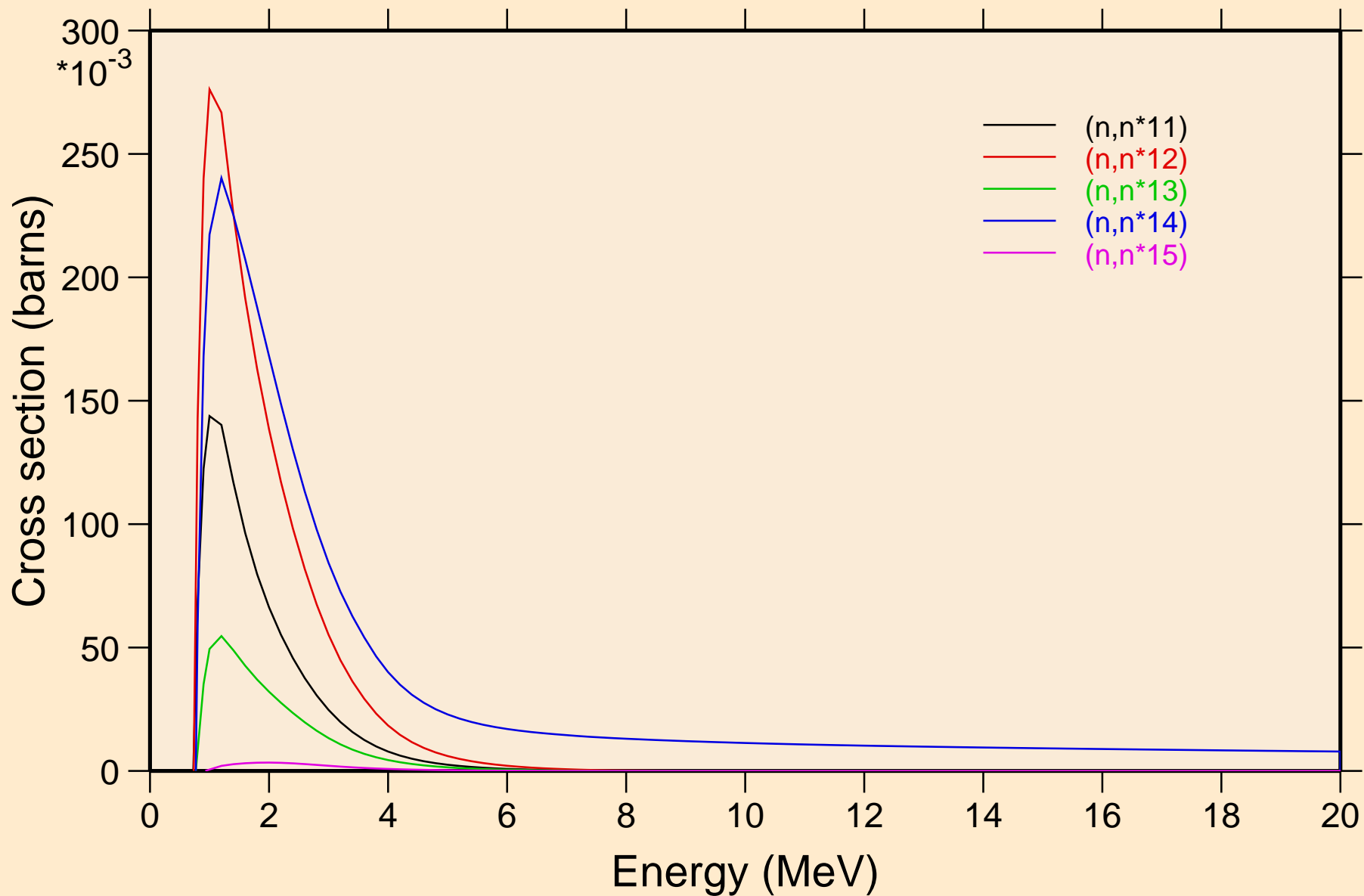

MAT=4331 ACE FILE PRODUCED AT NEA WITH NDEC
Inelastic levels

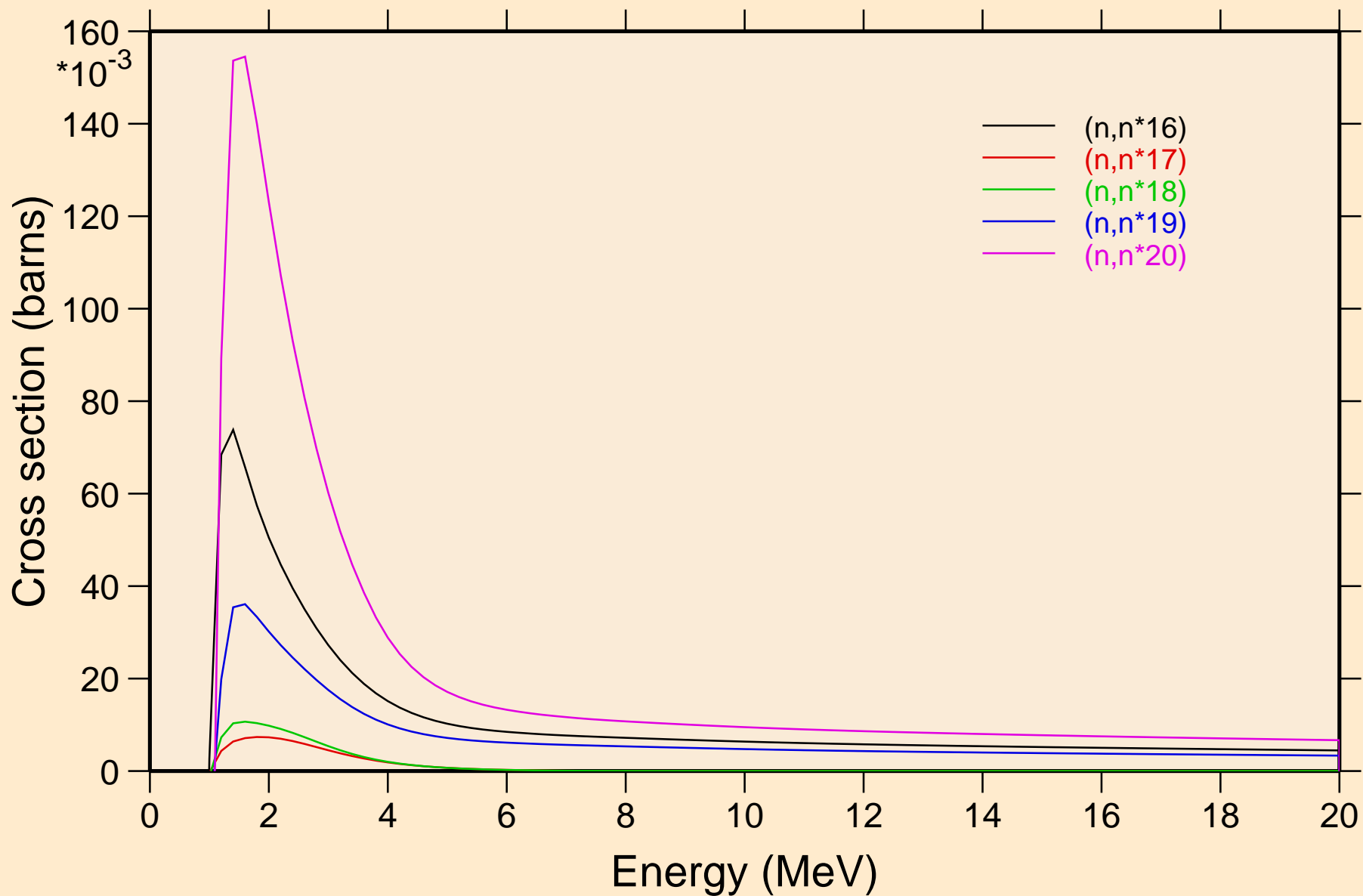

MAT=4331 ACE FILE PRODUCED AT NEA WITH NDEC
Threshold reactions

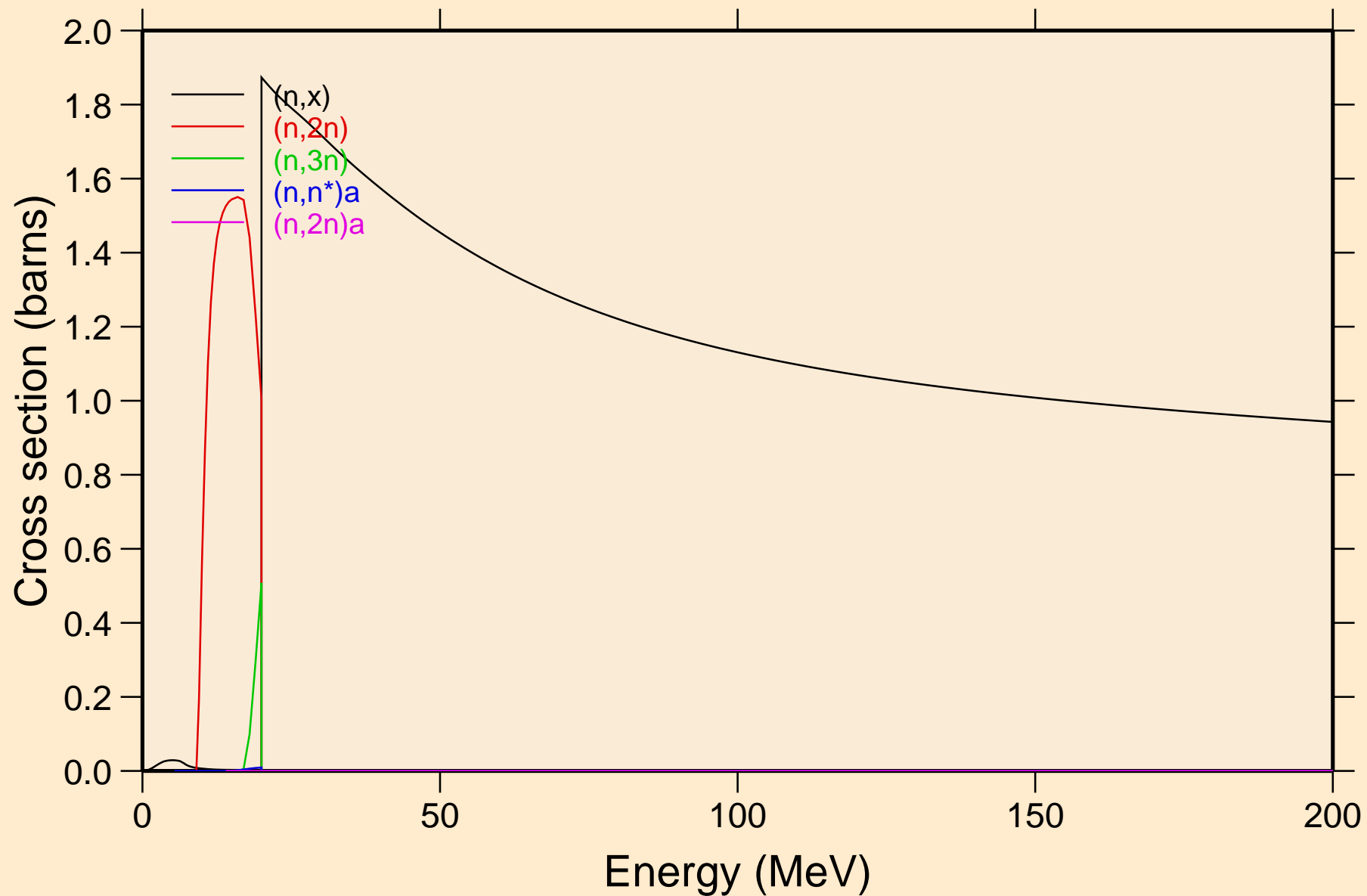

MAT=4331 ACE FILE PRODUCED AT NEA WITH NDEC
Threshold reactions

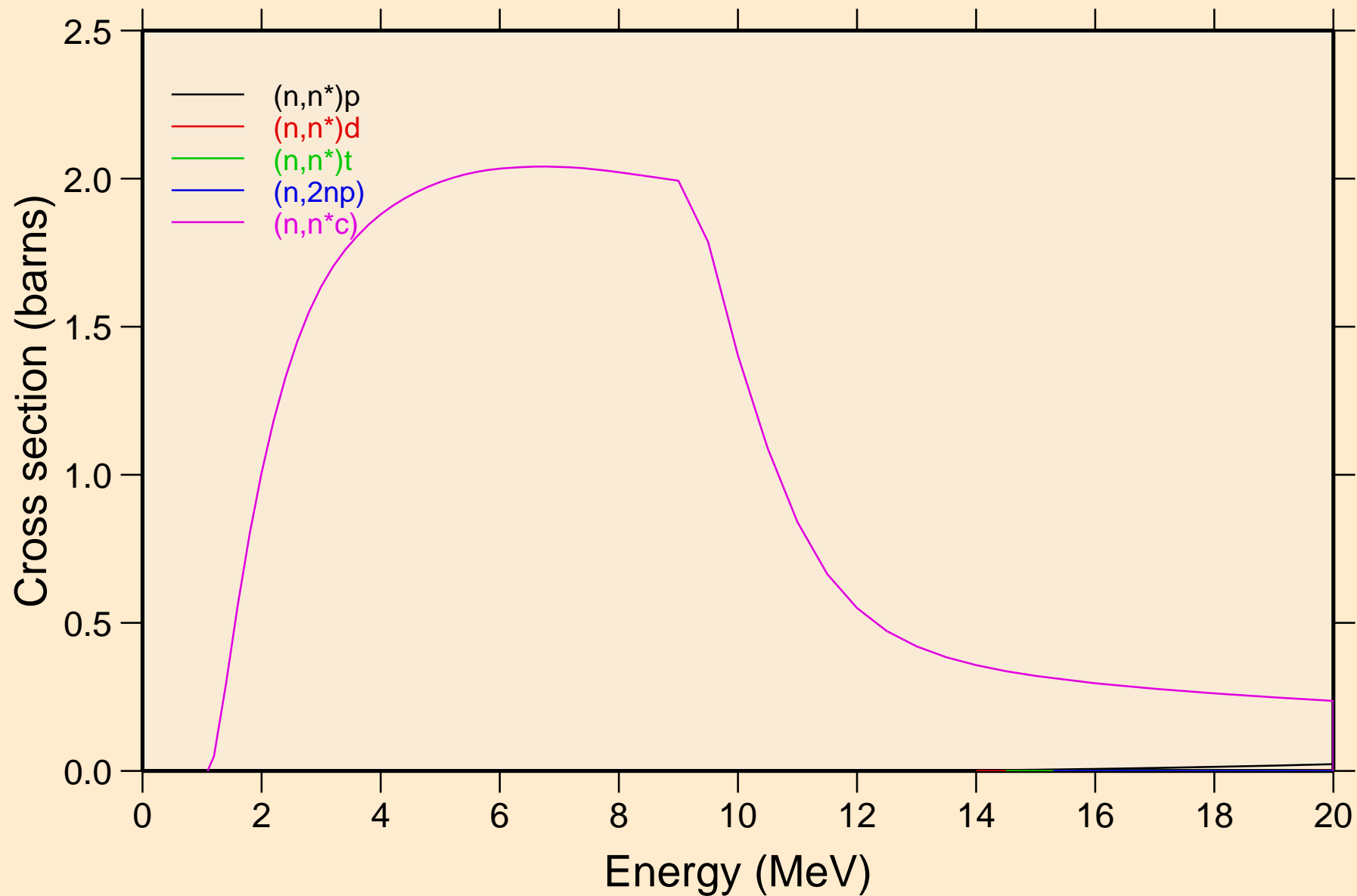

MAT=4331 ACE FILE PRODUCED AT NEA WITH NDEC
Threshold reactions

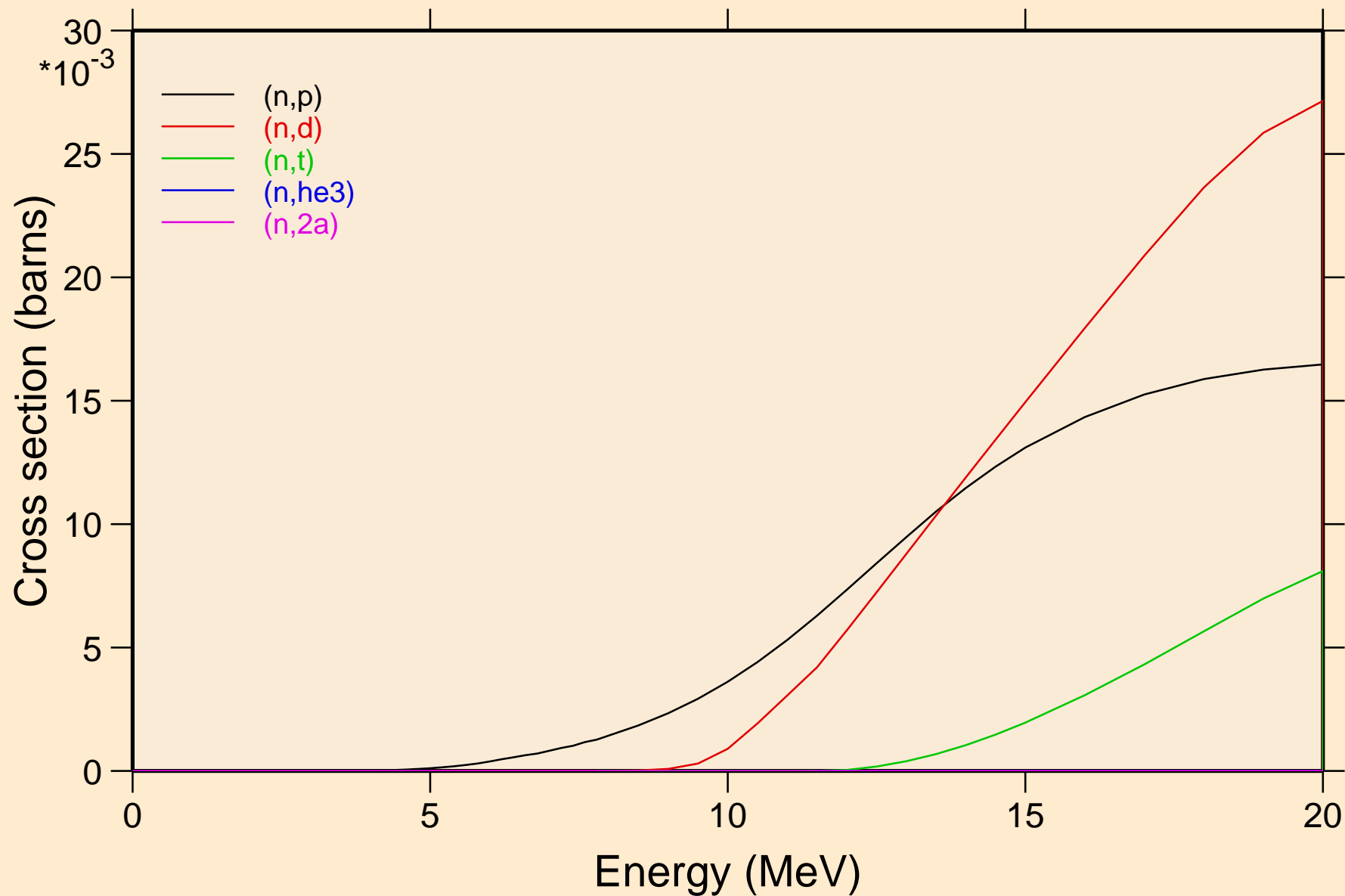

MAT=4331 ACE FILE PRODUCED AT NEA WITH NDEC
Threshold reactions

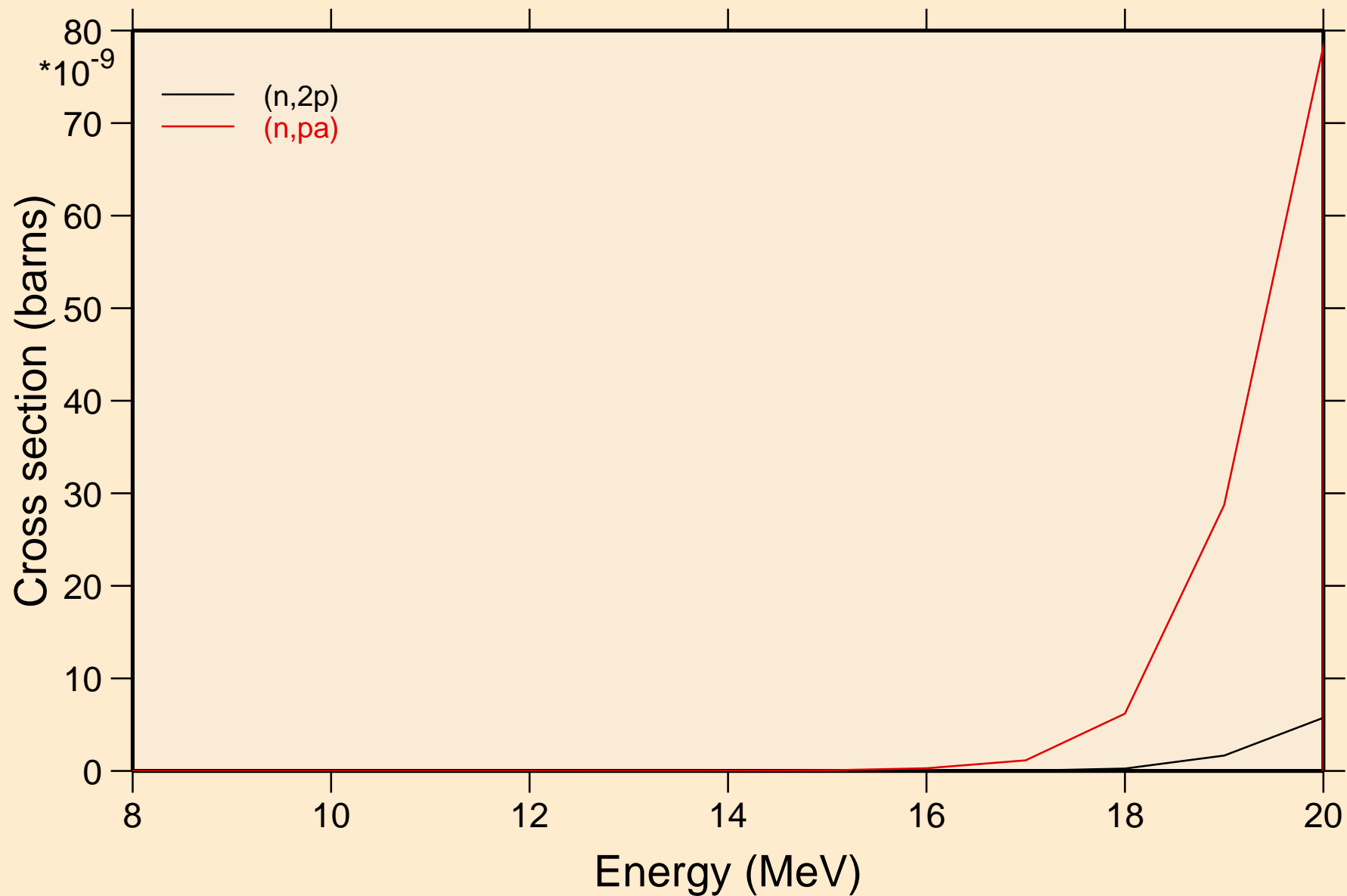

MAT=4331 ACE FILE PRODUCED AT NEA WITH NDEC
Threshold reactions

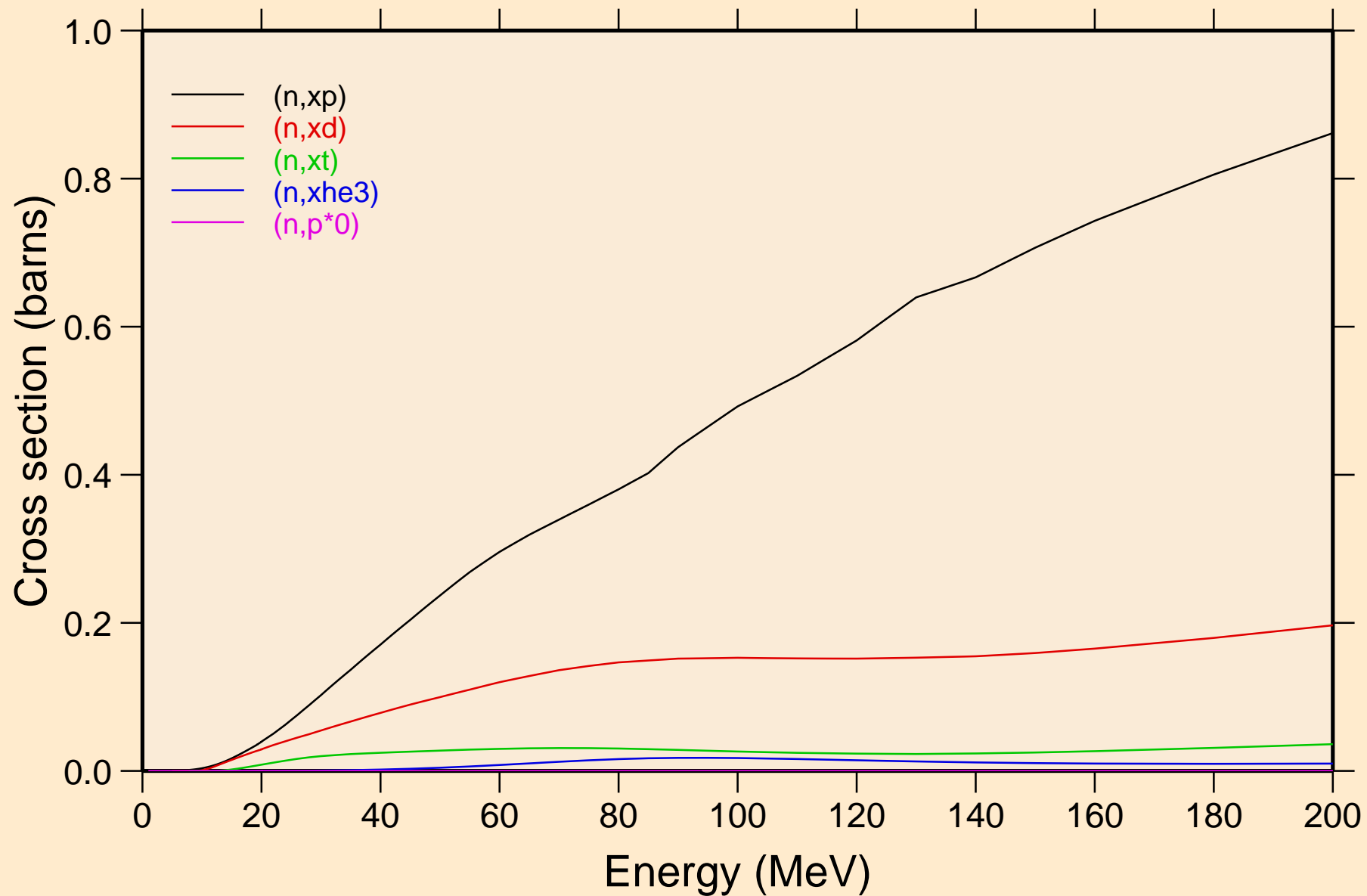

MAT=4331 ACE FILE PRODUCED AT NEA WITH NDEC
Threshold reactions

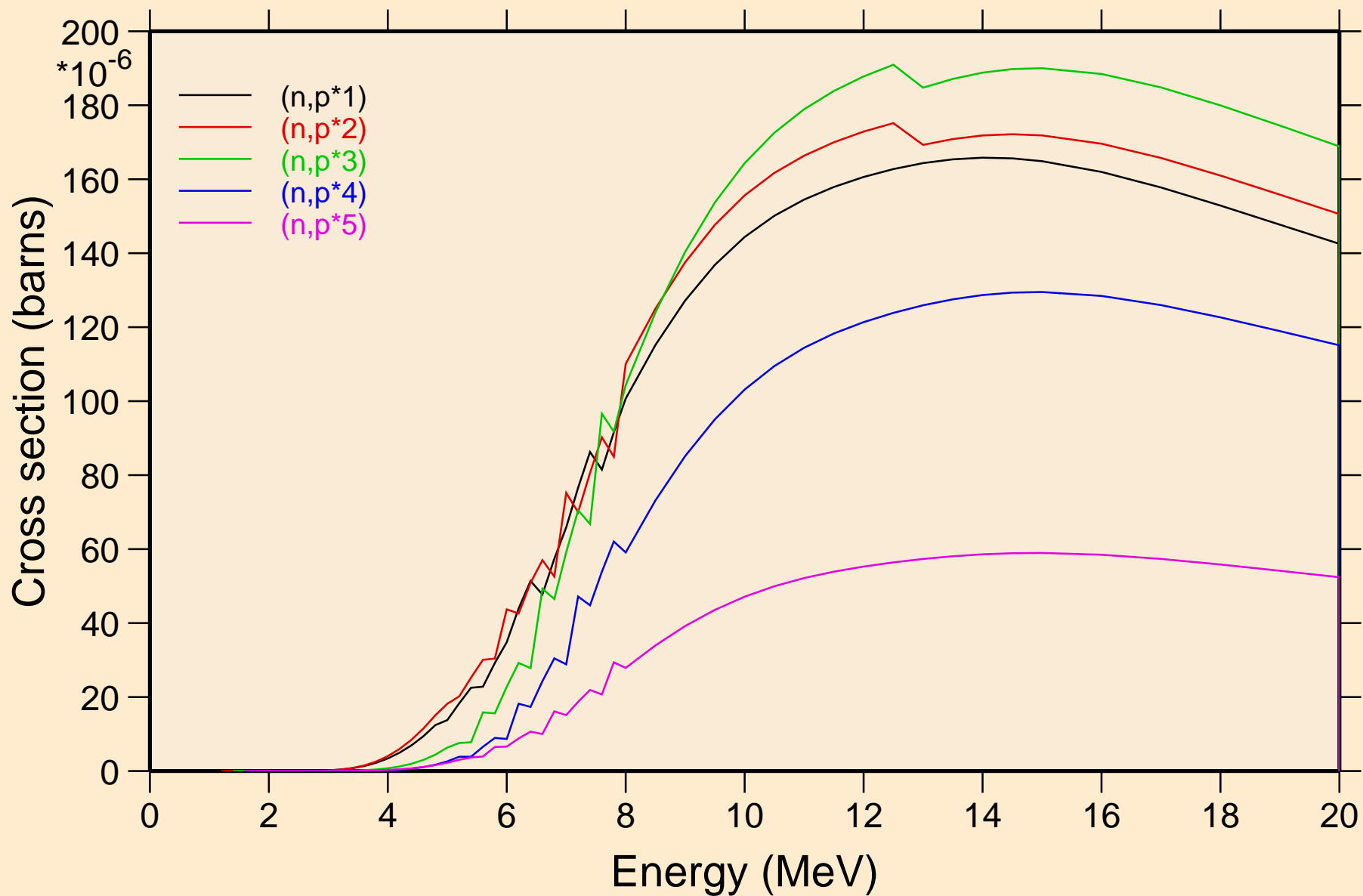

MAT=4331 ACE FILE PRODUCED AT NEA WITH NDEC
Threshold reactions

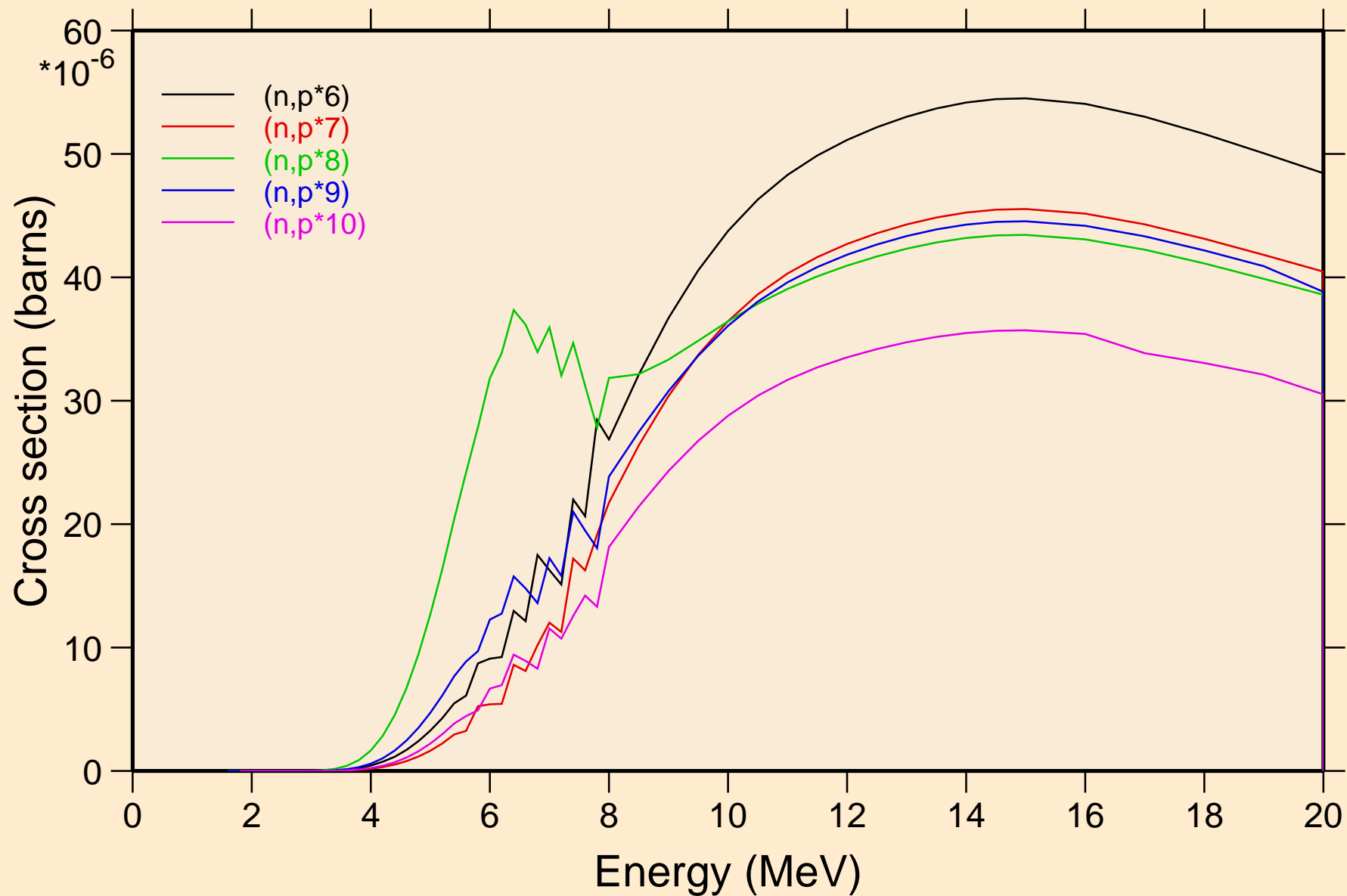

MAT=4331 ACE FILE PRODUCED AT NEA WITH NDEC
Threshold reactions

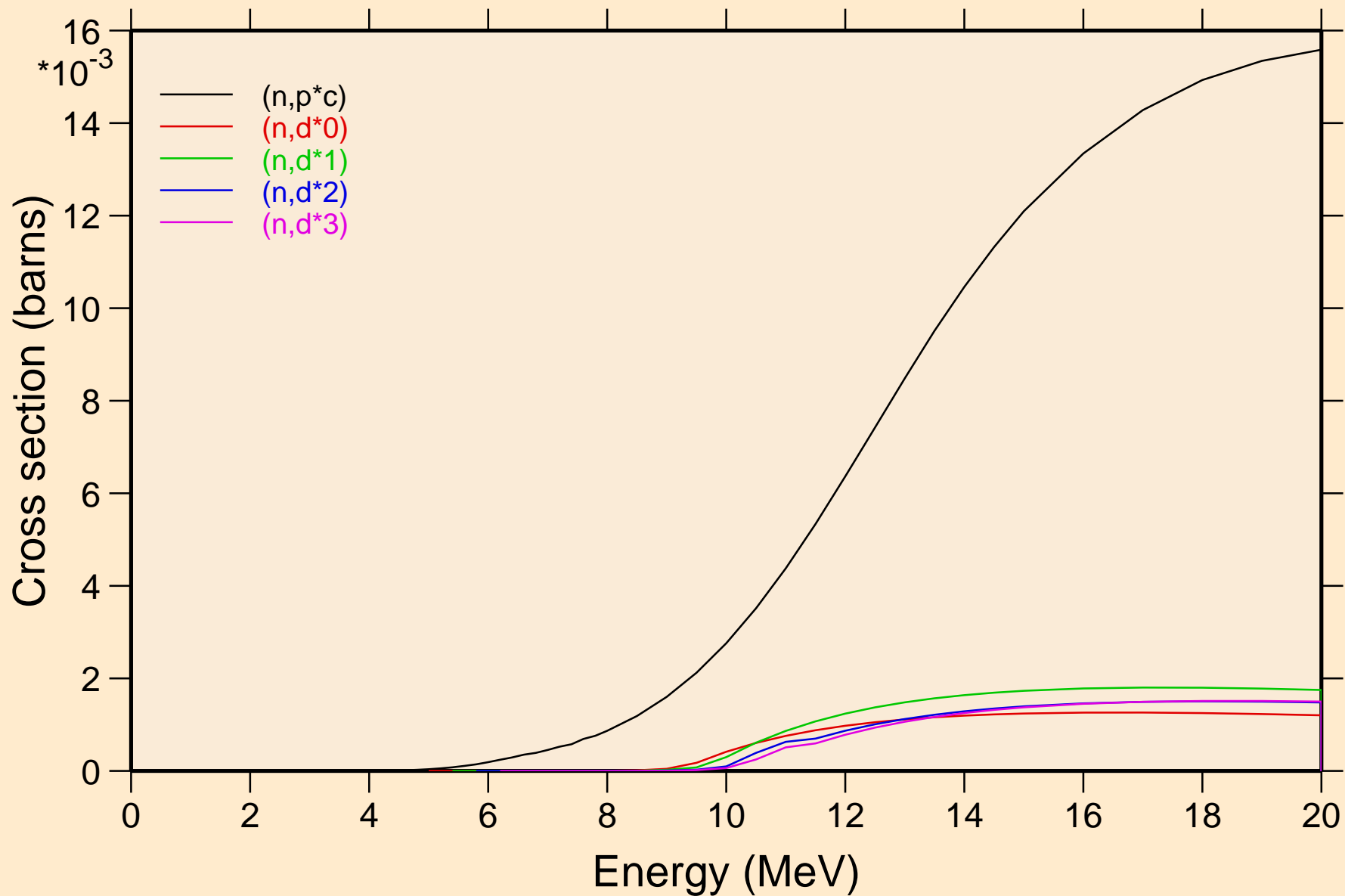

MAT=4331 ACE FILE PRODUCED AT NEA WITH NDEC
Threshold reactions

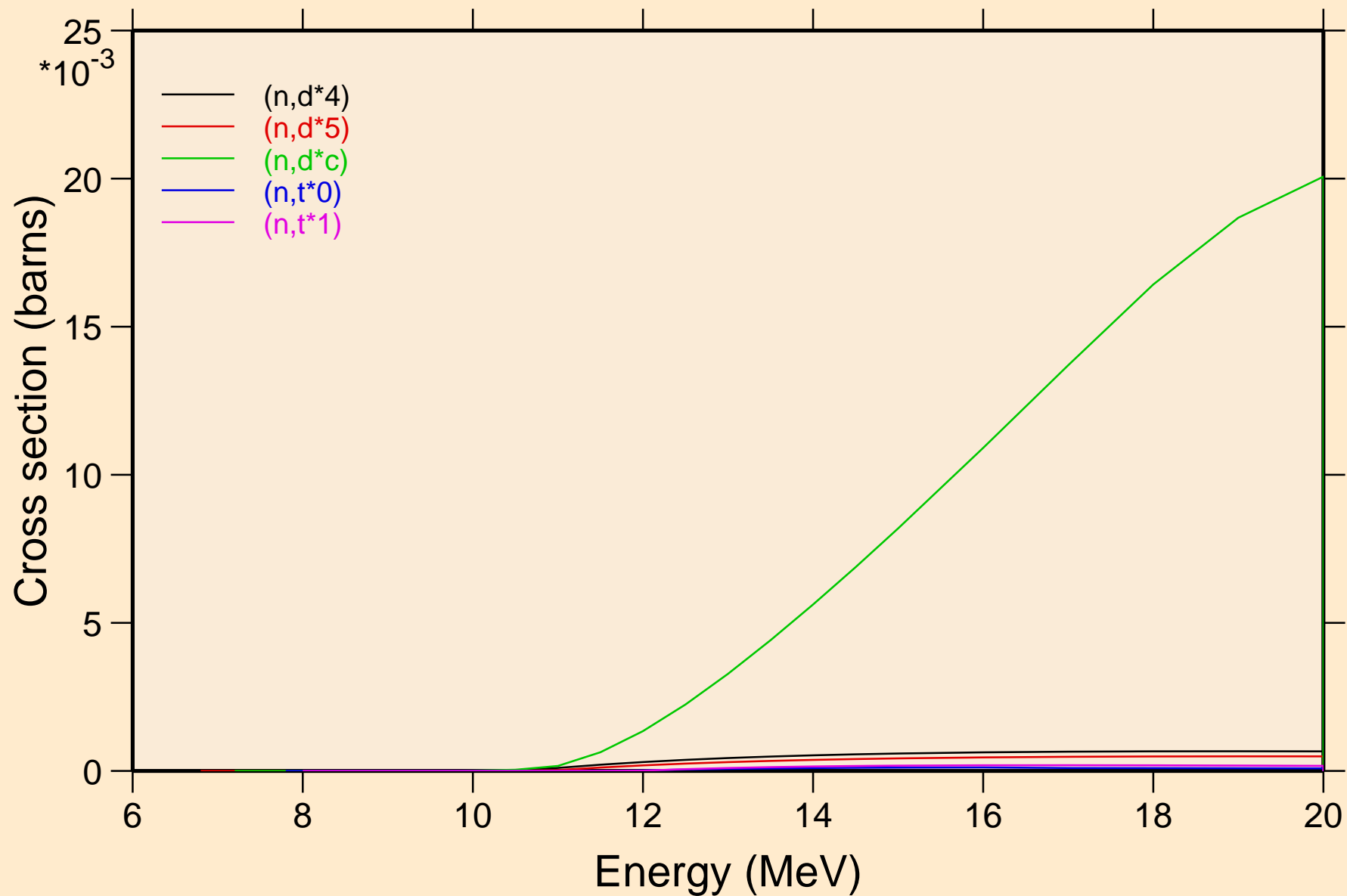

MAT=4331 ACE FILE PRODUCED AT NEA WITH NDEC
Threshold reactions

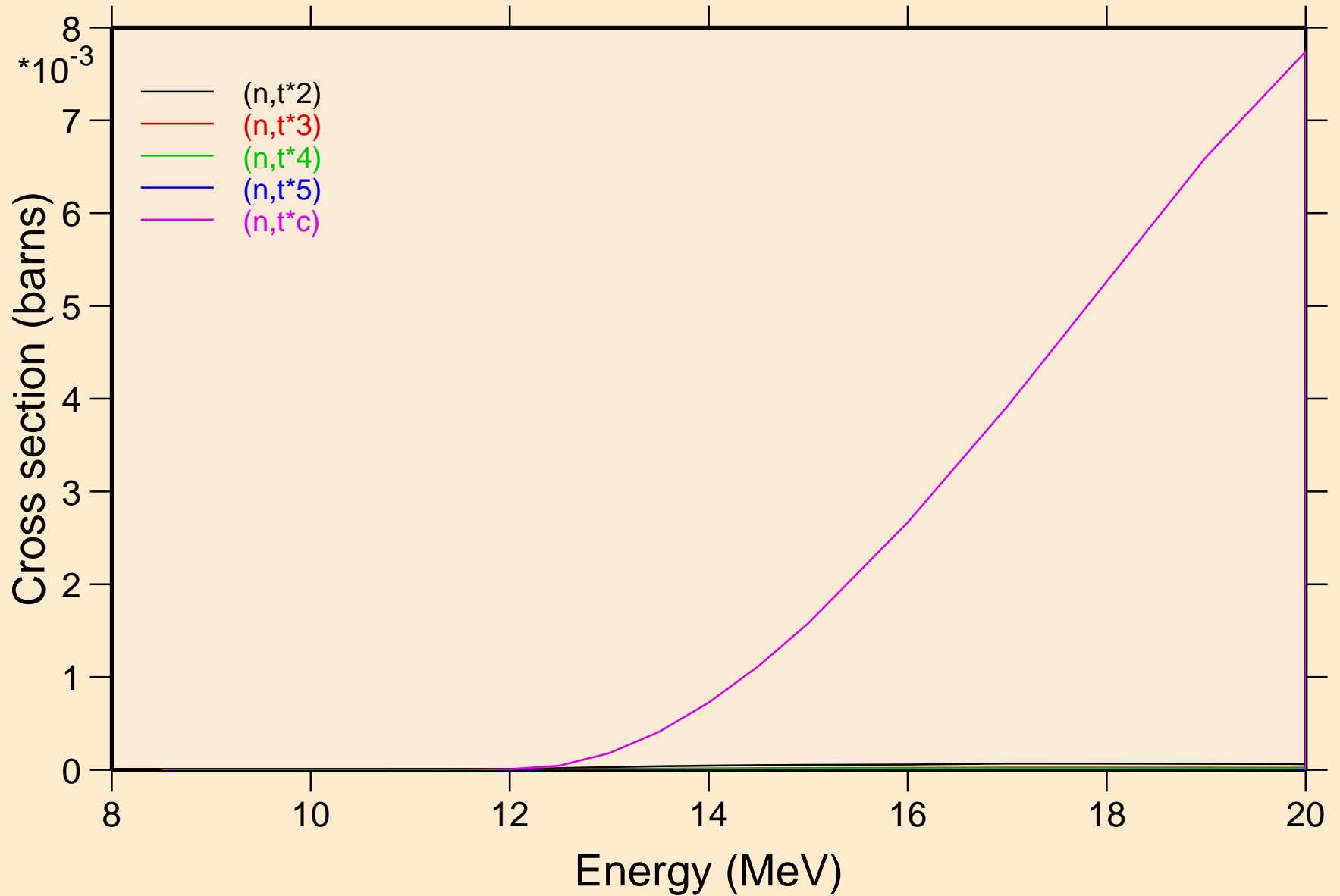

MAT=4331 ACE FILE PRODUCED AT NEA WITH NDEC
Threshold reactions

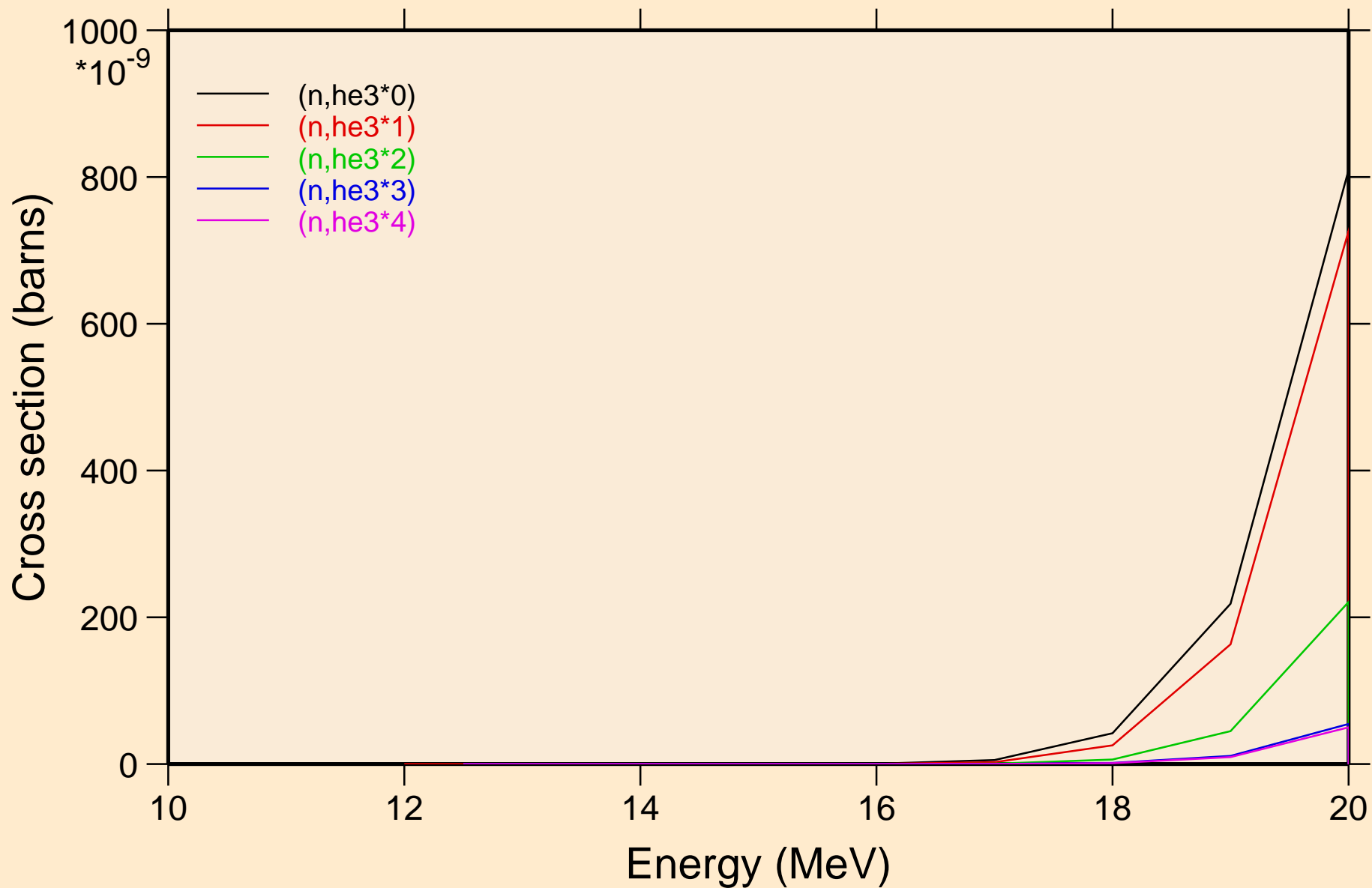

MAT=4331 ACE FILE PRODUCED AT NEA WITH NDEC
Threshold reactions

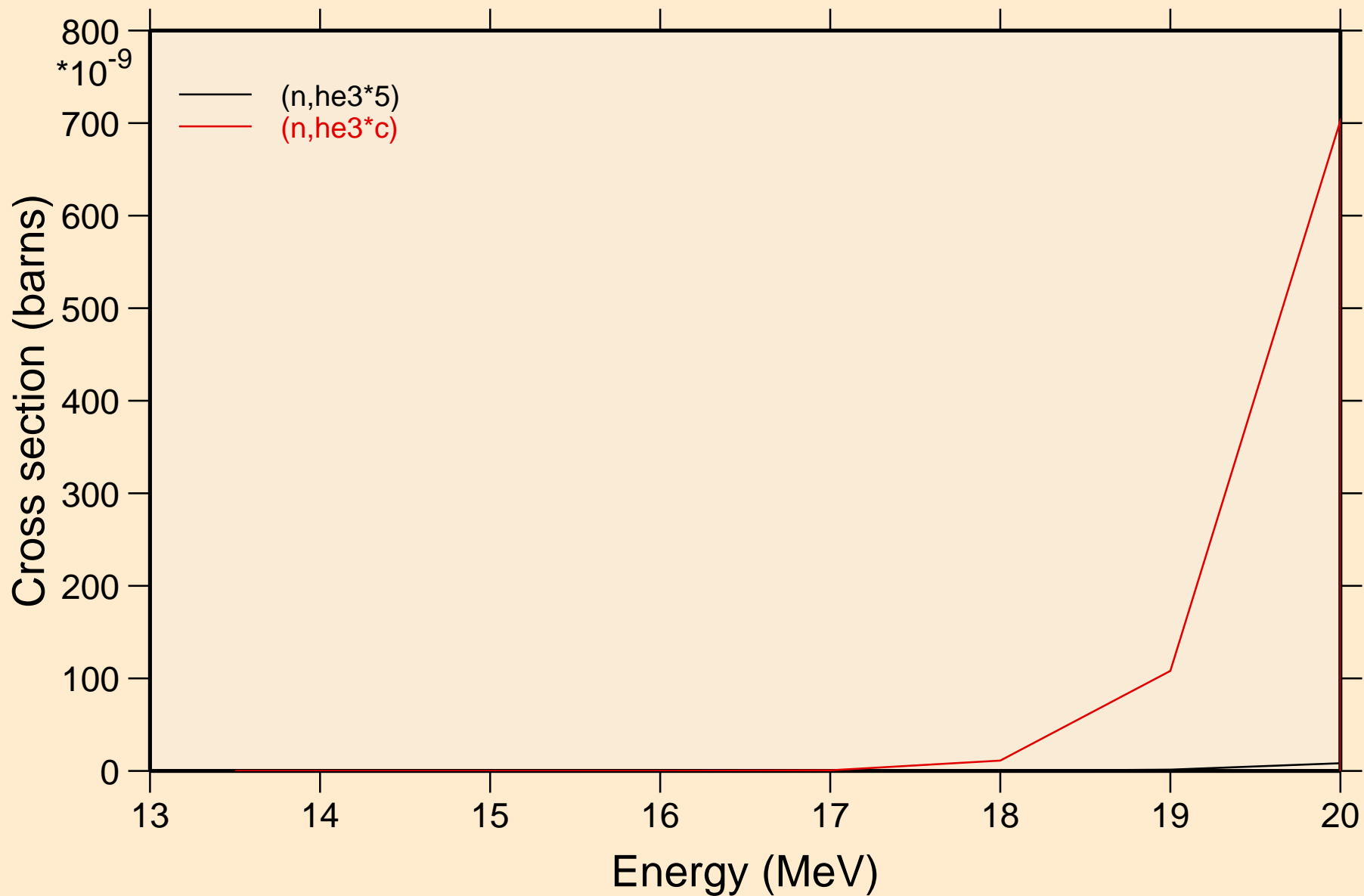

MAT=4331 ACE FILE PRODUCED AT NEA WITH NDEC
angular distribution for elastic

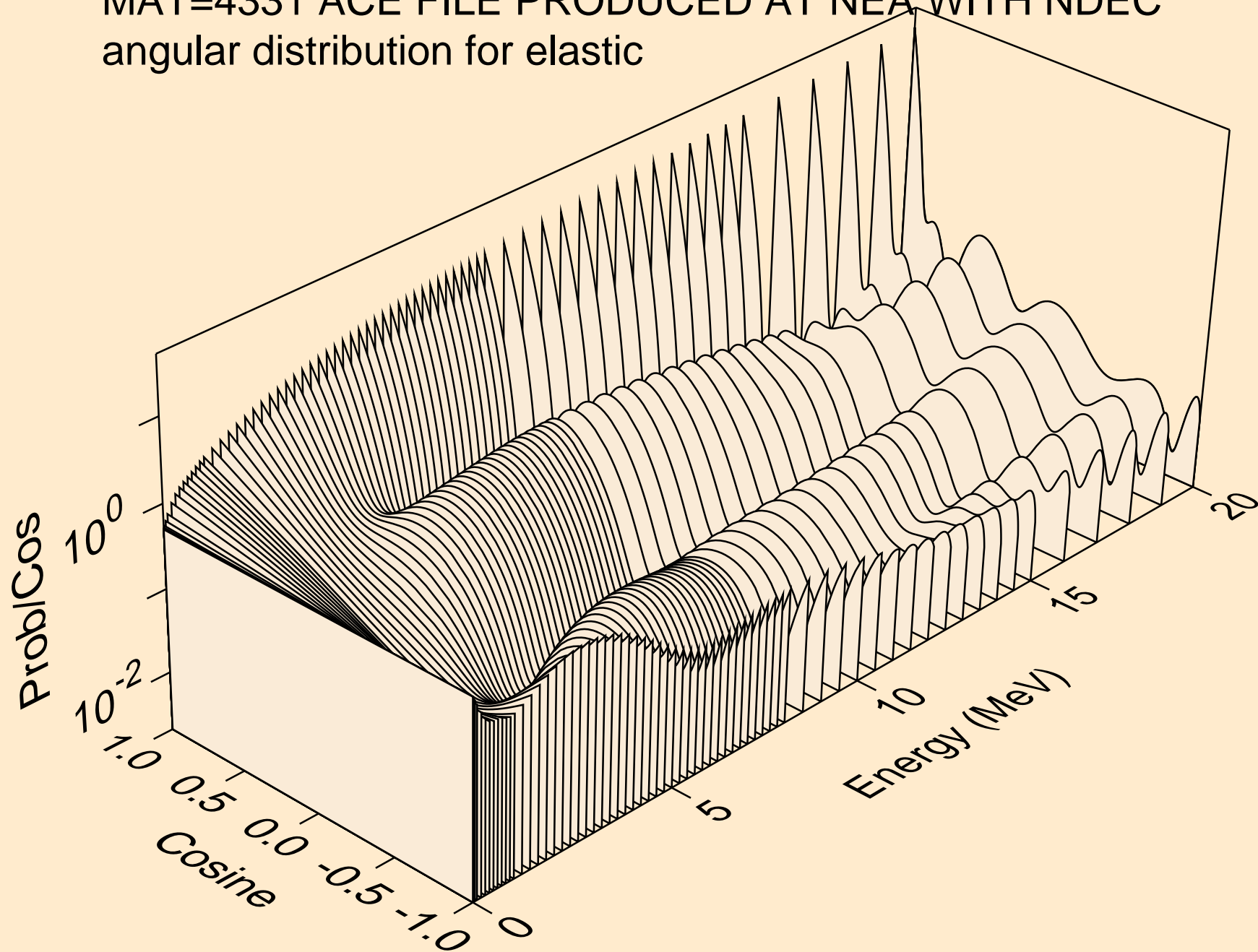

MAT=4331 ACE FILE PRODUCED AT NEA WITH NDEC
angular distribution for elastic

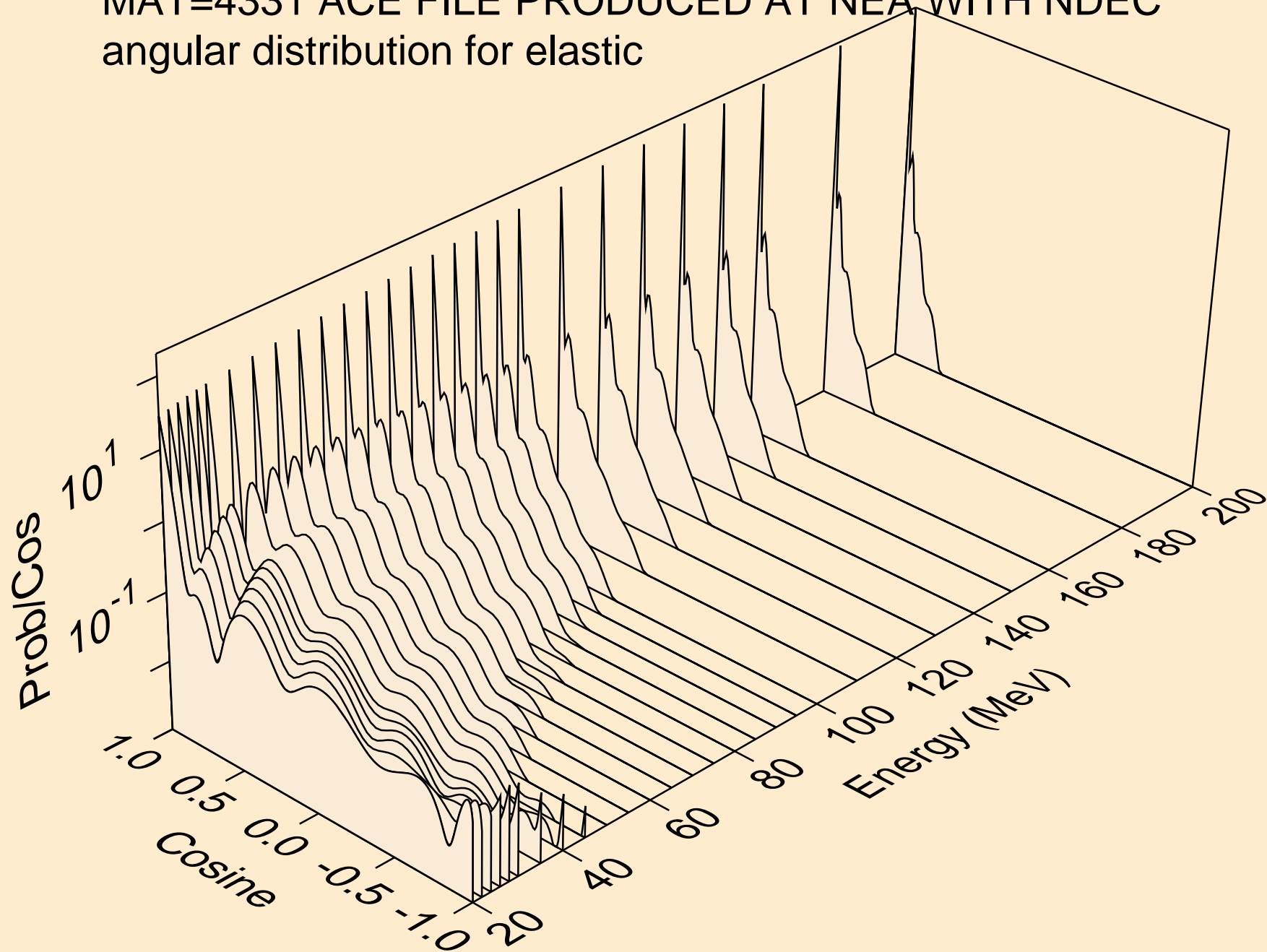

MAT=4331 ACE FILE PRODUCED AT NEA WITH NDEC
angular distribution for (n,n*1)

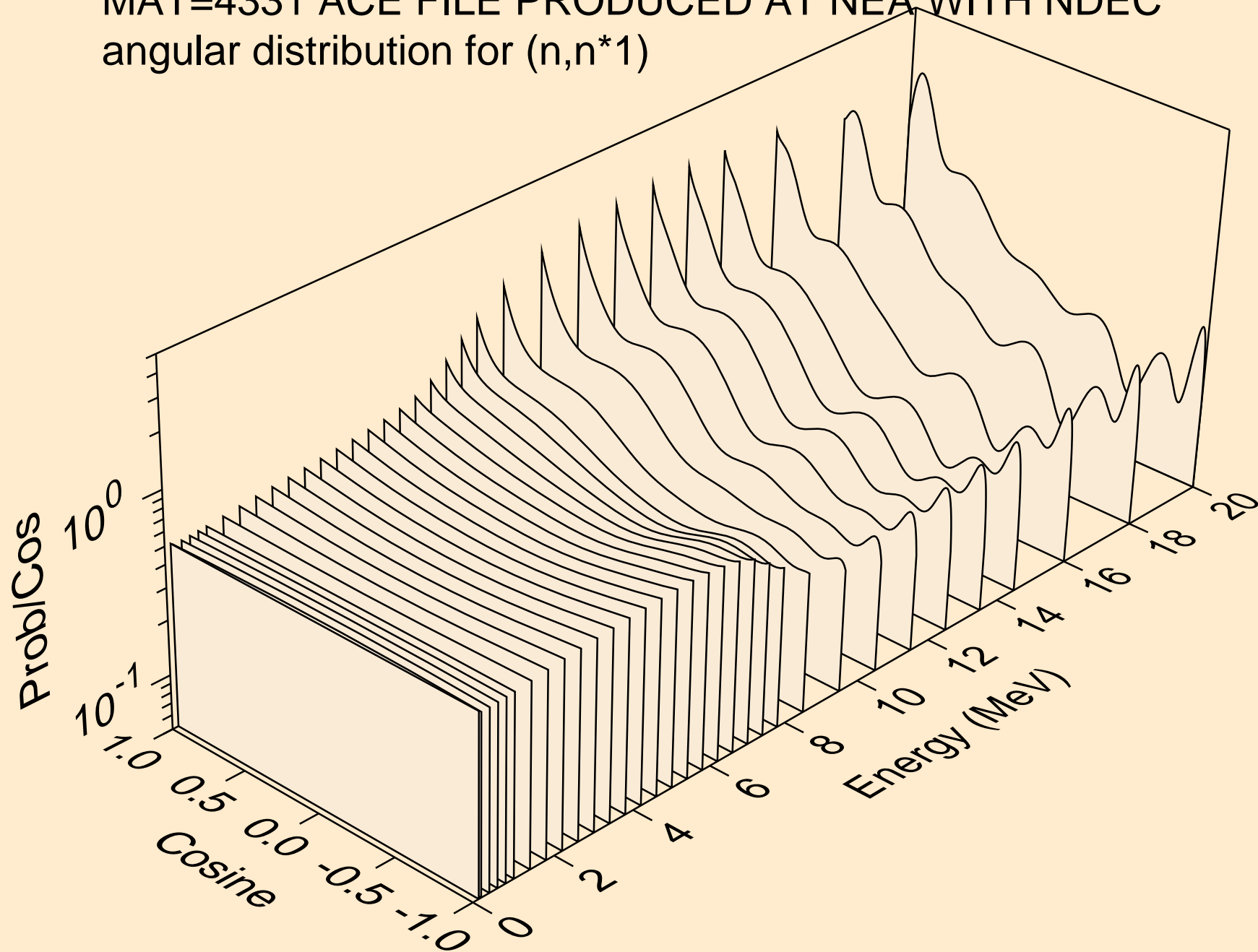

MAT=4331 ACE FILE PRODUCED AT NEA WITH NDEC
angular distribution for (n,n*2)

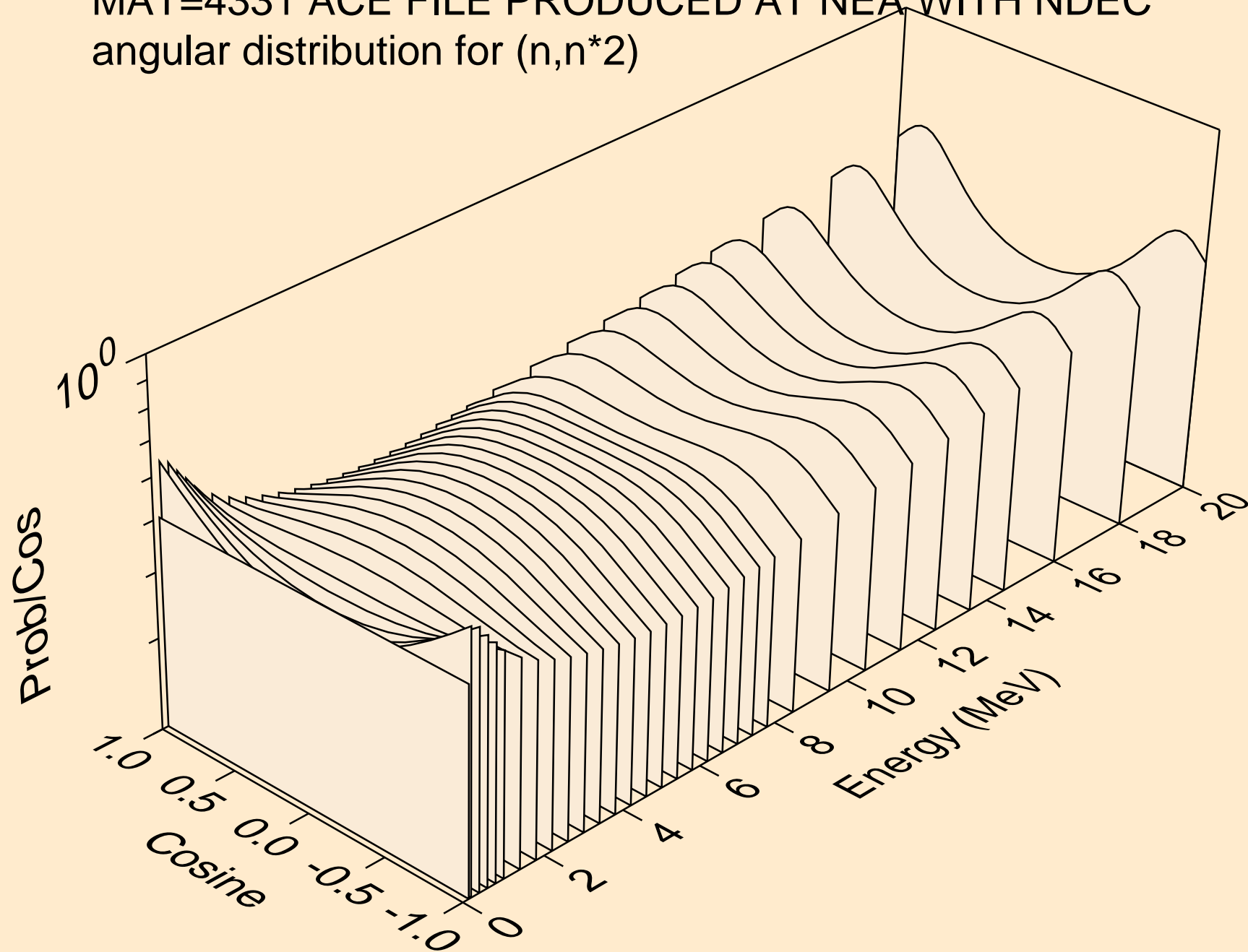

MAT=4331 ACE FILE PRODUCED AT NEA WITH NDEC
angular distribution for (n,n*3)

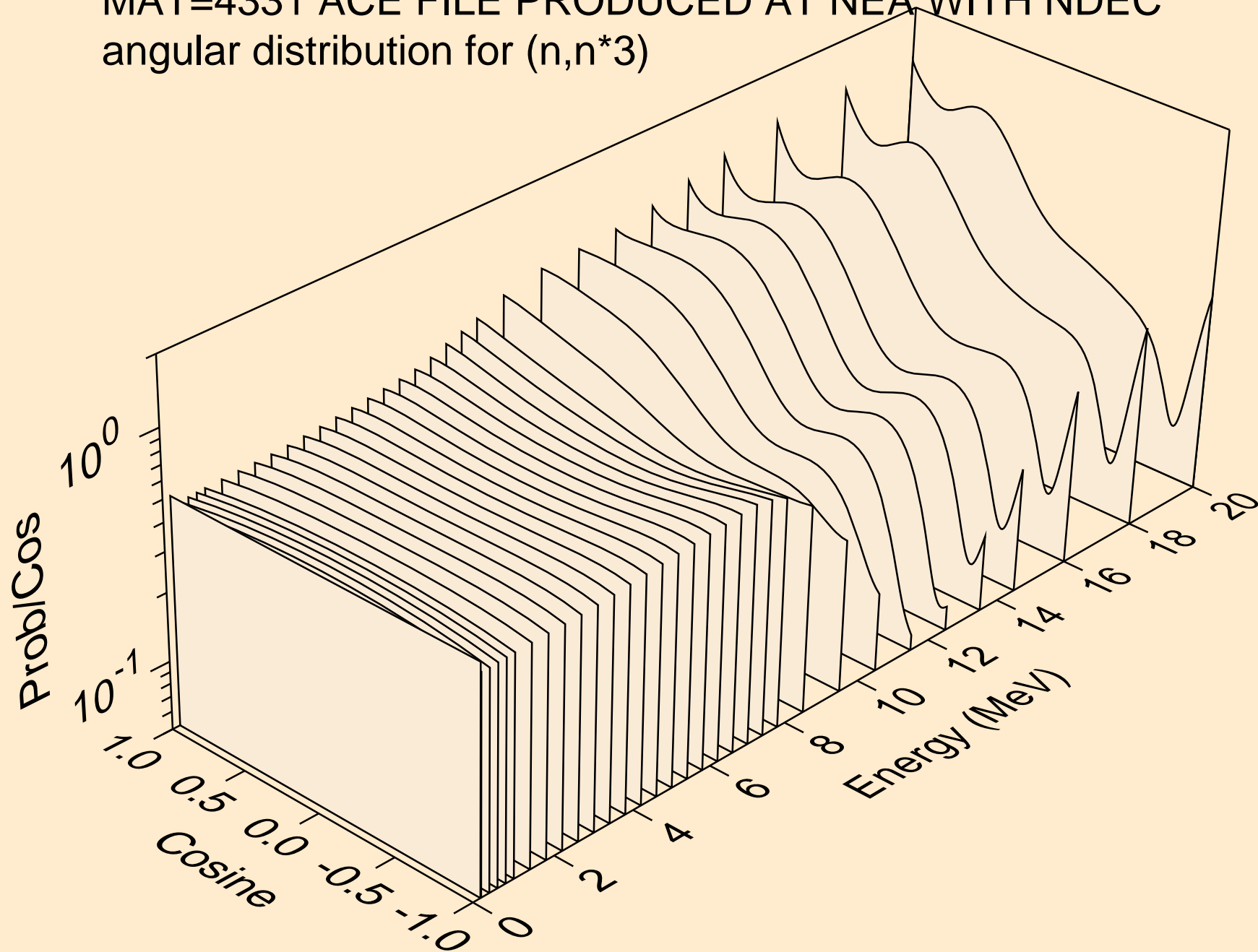

MAT=4331 ACE FILE PRODUCED AT NEA WITH NDEC
angular distribution for (n,n*4)

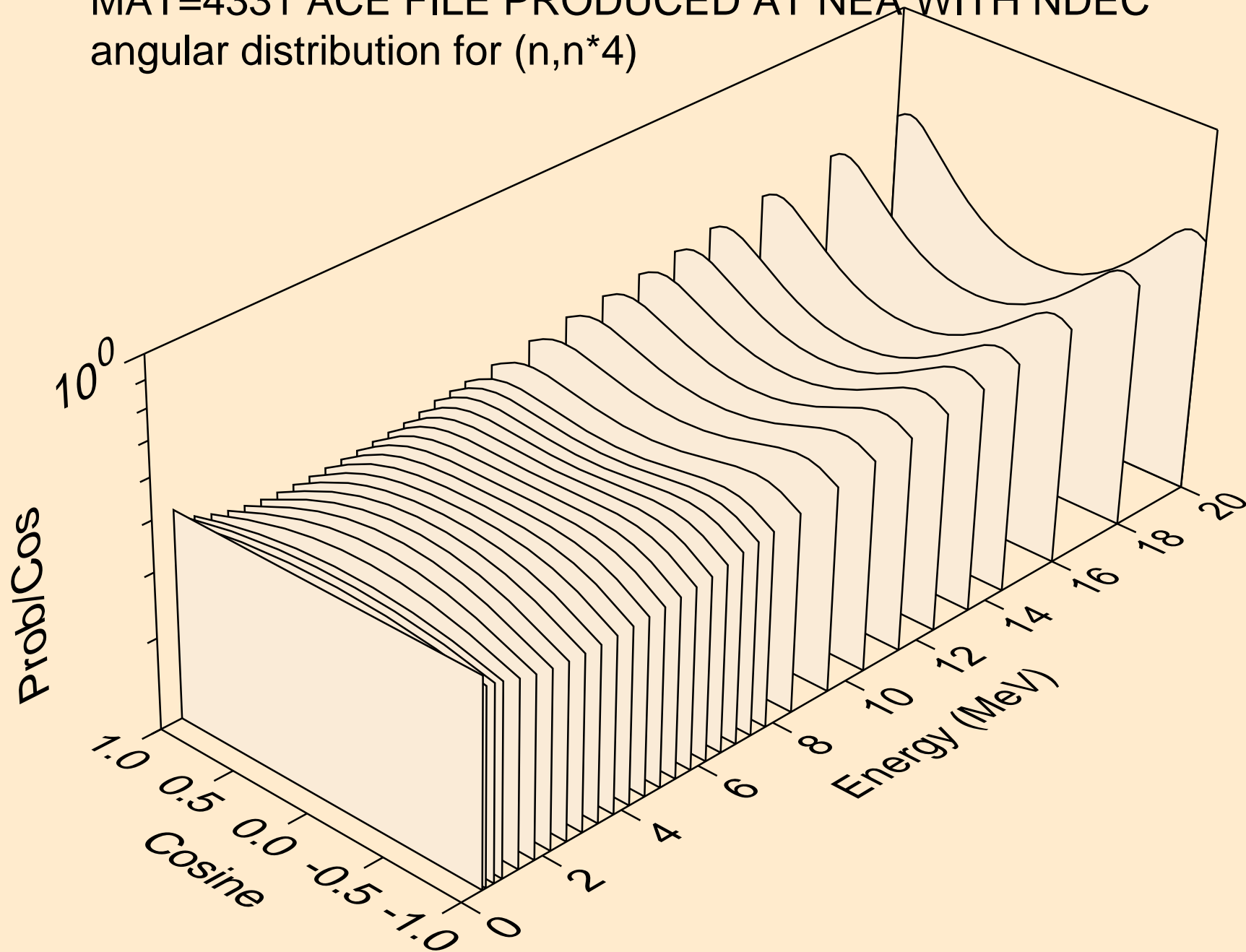

MAT=4331 ACE FILE PRODUCED AT NEA WITH NDEC
angular distribution for (n,n*5)

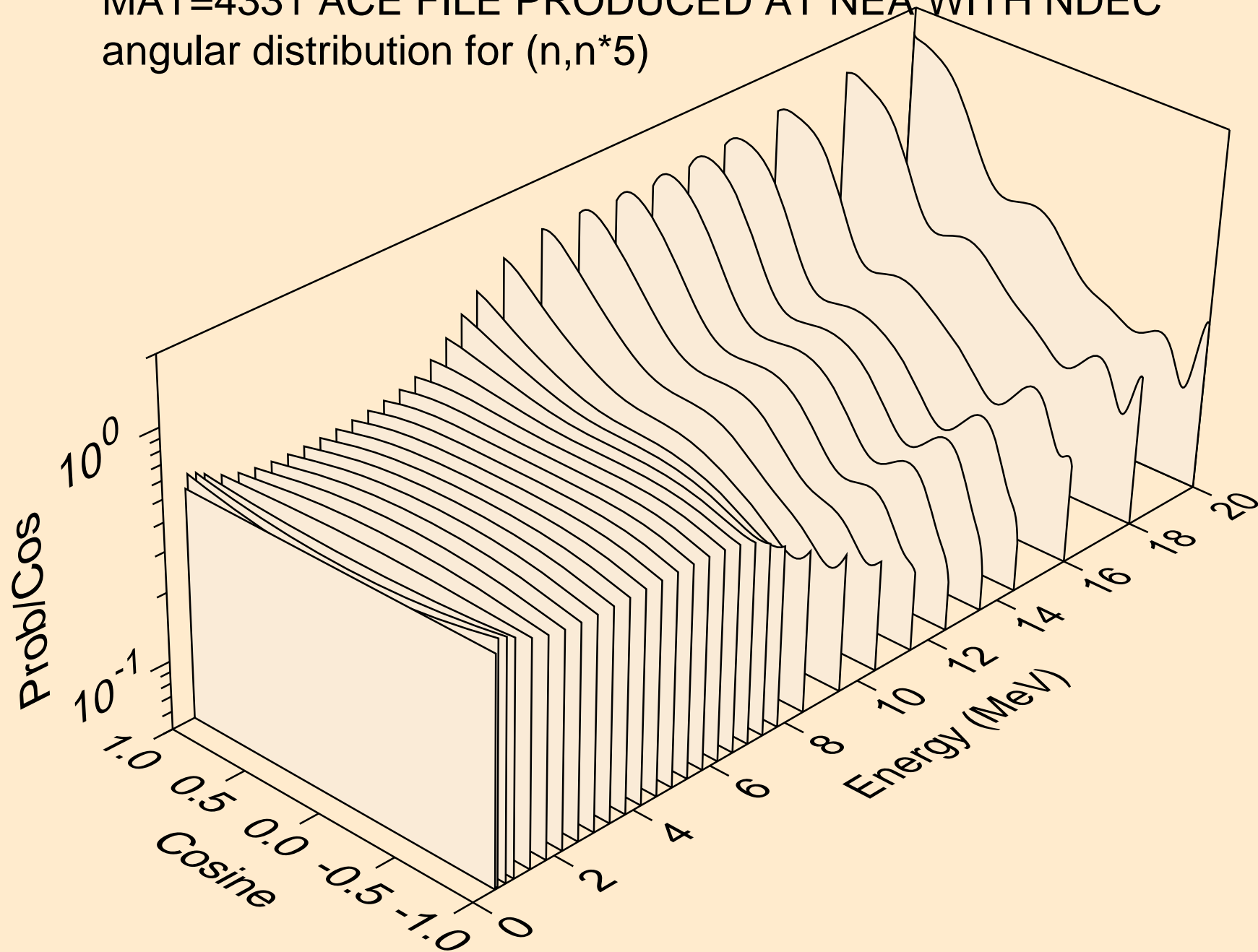

MAT=4331 ACE FILE PRODUCED AT NEA WITH NDEC
angular distribution for (n,n*6)



MAT=4331 ACE FILE PRODUCED AT NEA WITH NDEC
angular distribution for (n,n*7)

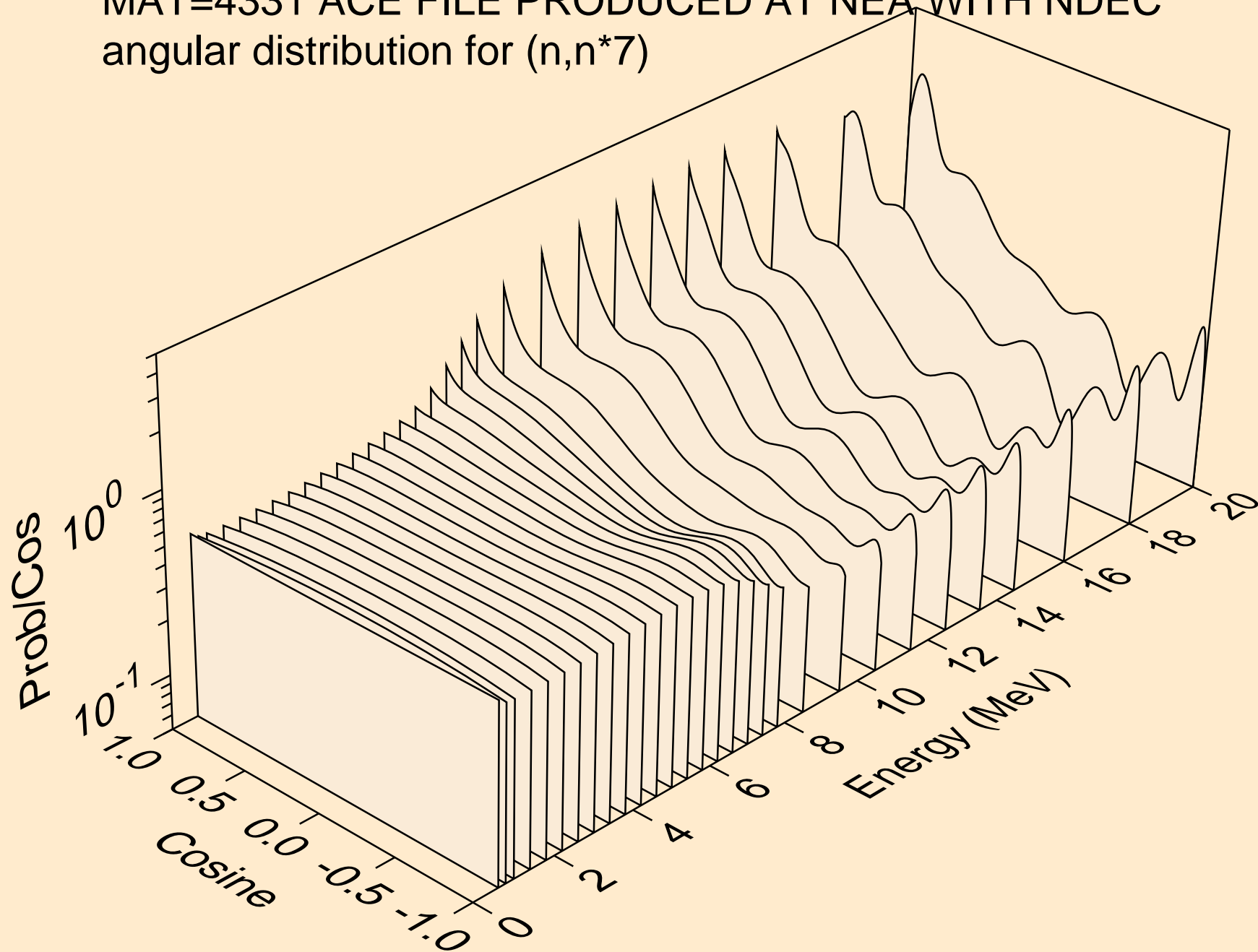

MAT=4331 ACE FILE PRODUCED AT NEA WITH NDEC
angular distribution for (n,n*8)

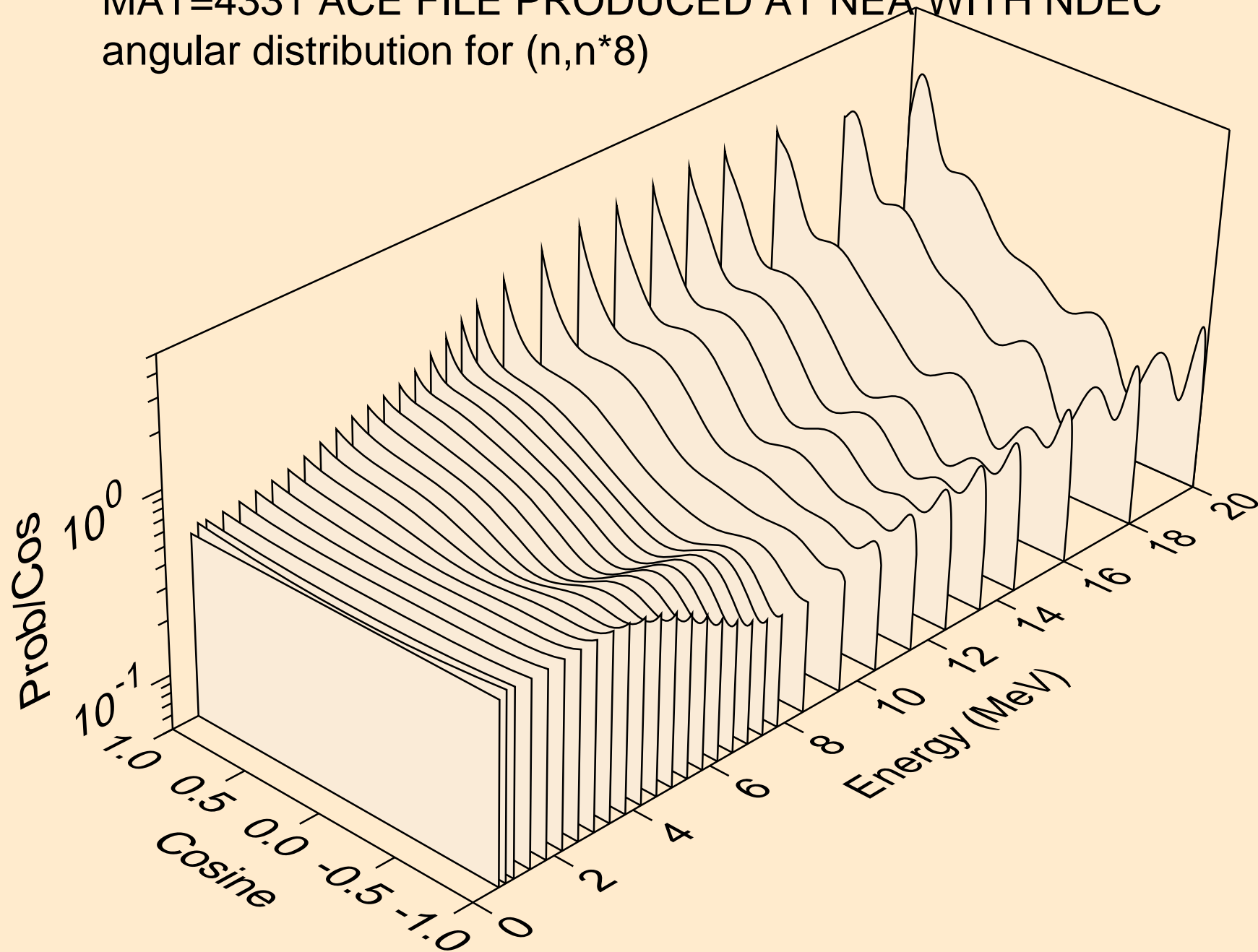

MAT=4331 ACE FILE PRODUCED AT NEA WITH NDEC
angular distribution for (n,n*9)

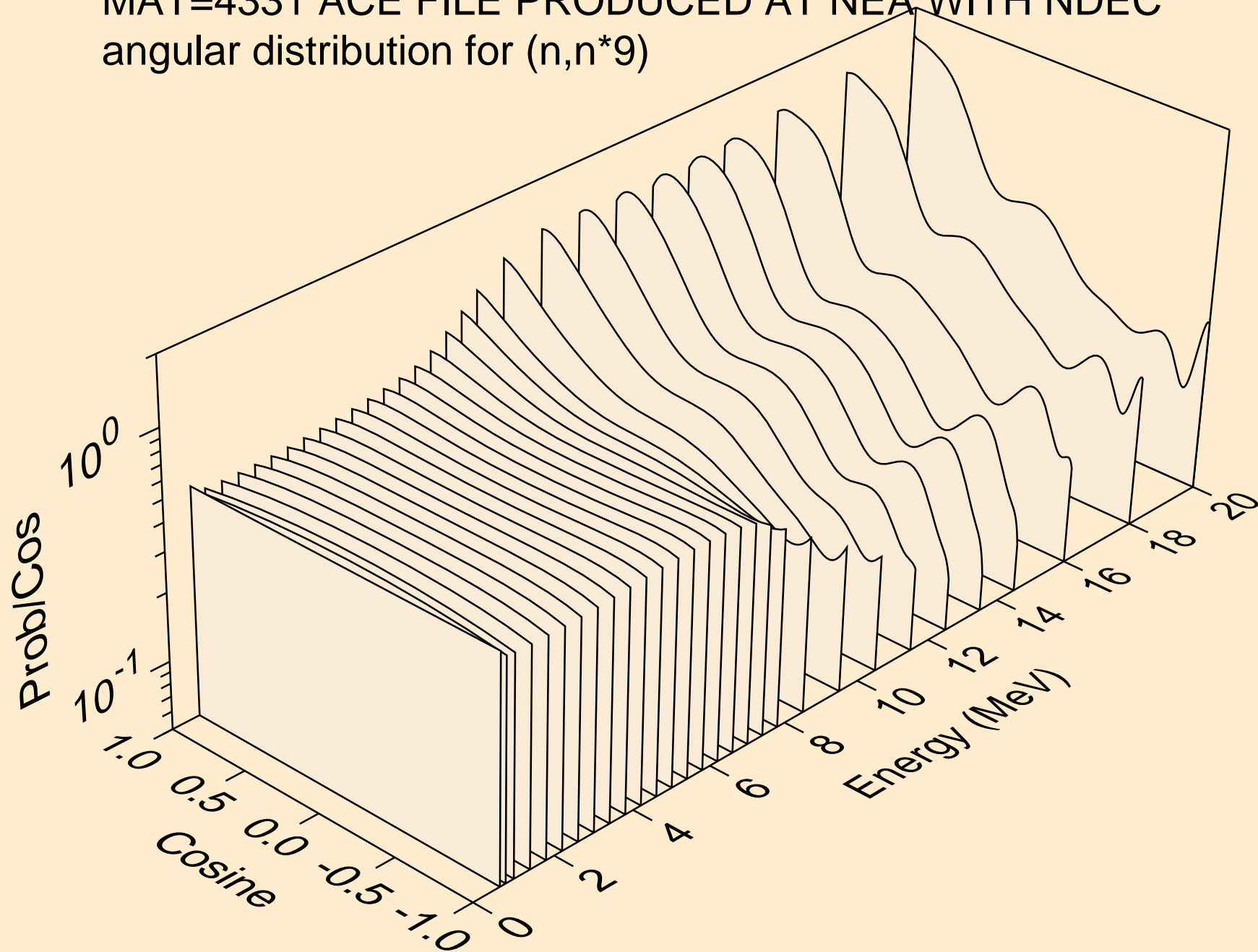

MAT=4331 ACE FILE PRODUCED AT NEA WITH NDEC
angular distribution for (n,n*10)

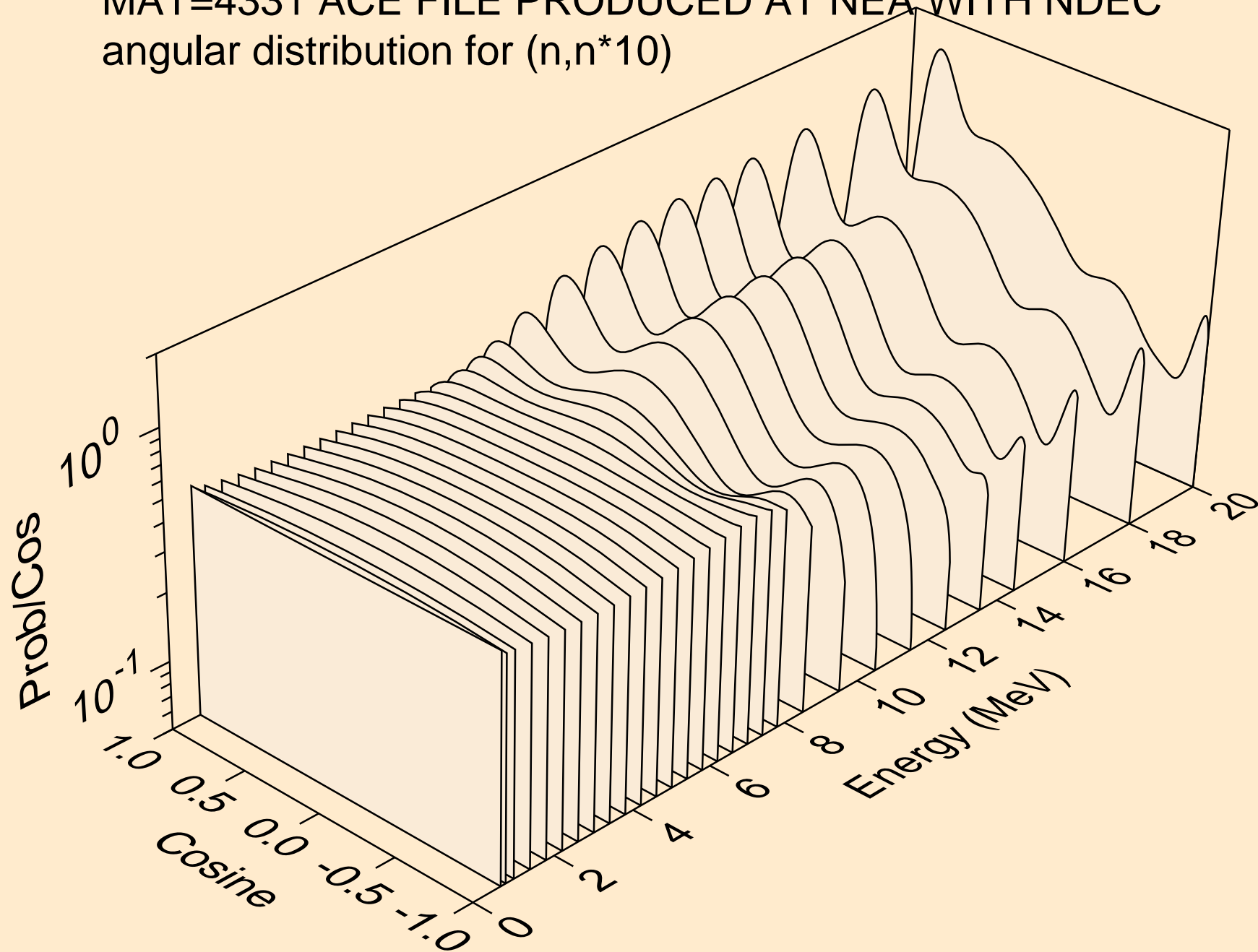

MAT=4331 ACE FILE PRODUCED AT NEA WITH NDEC
angular distribution for (n,n*11)

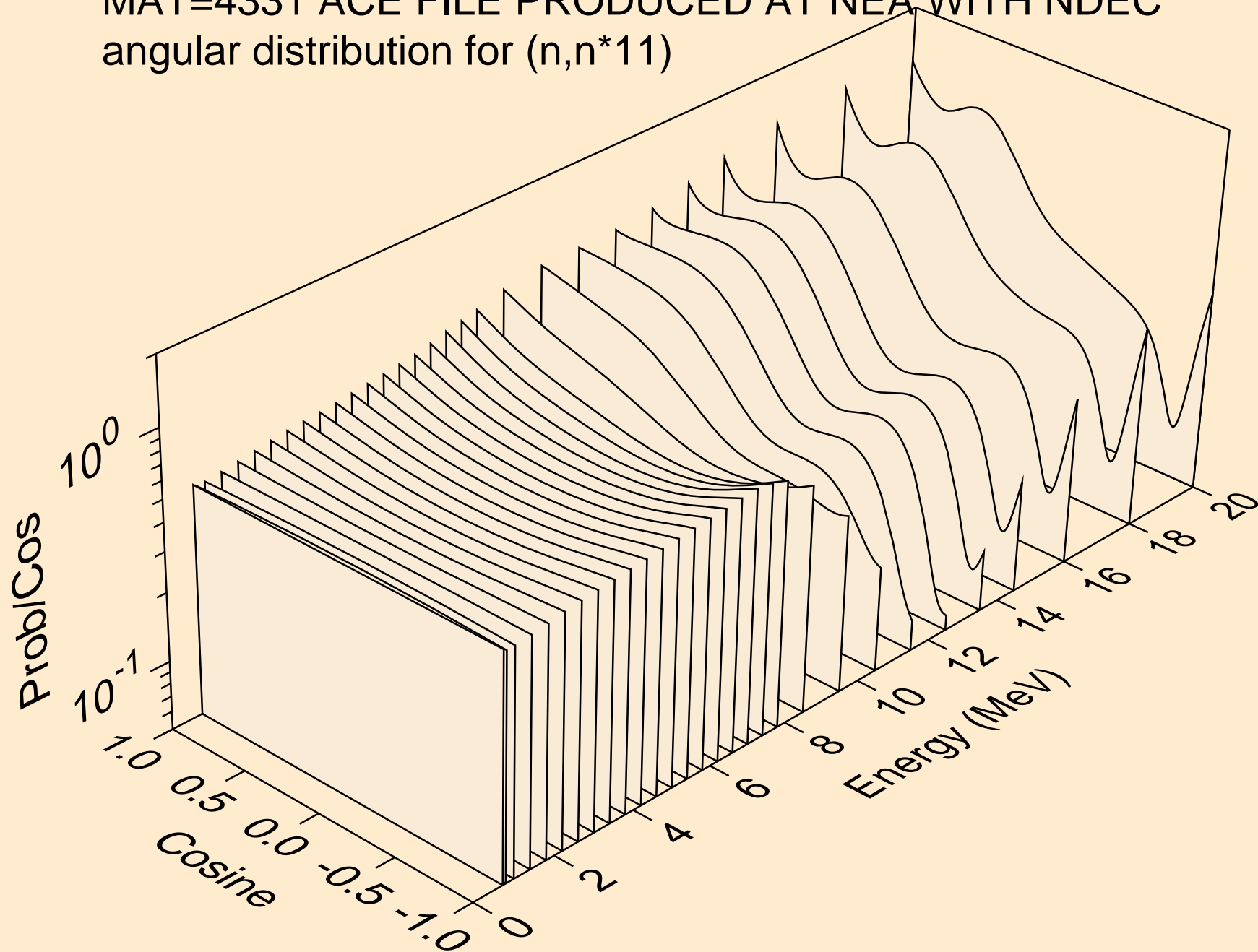

MAT=4331 ACE FILE PRODUCED AT NEA WITH NDEC
angular distribution for (n,n*12)

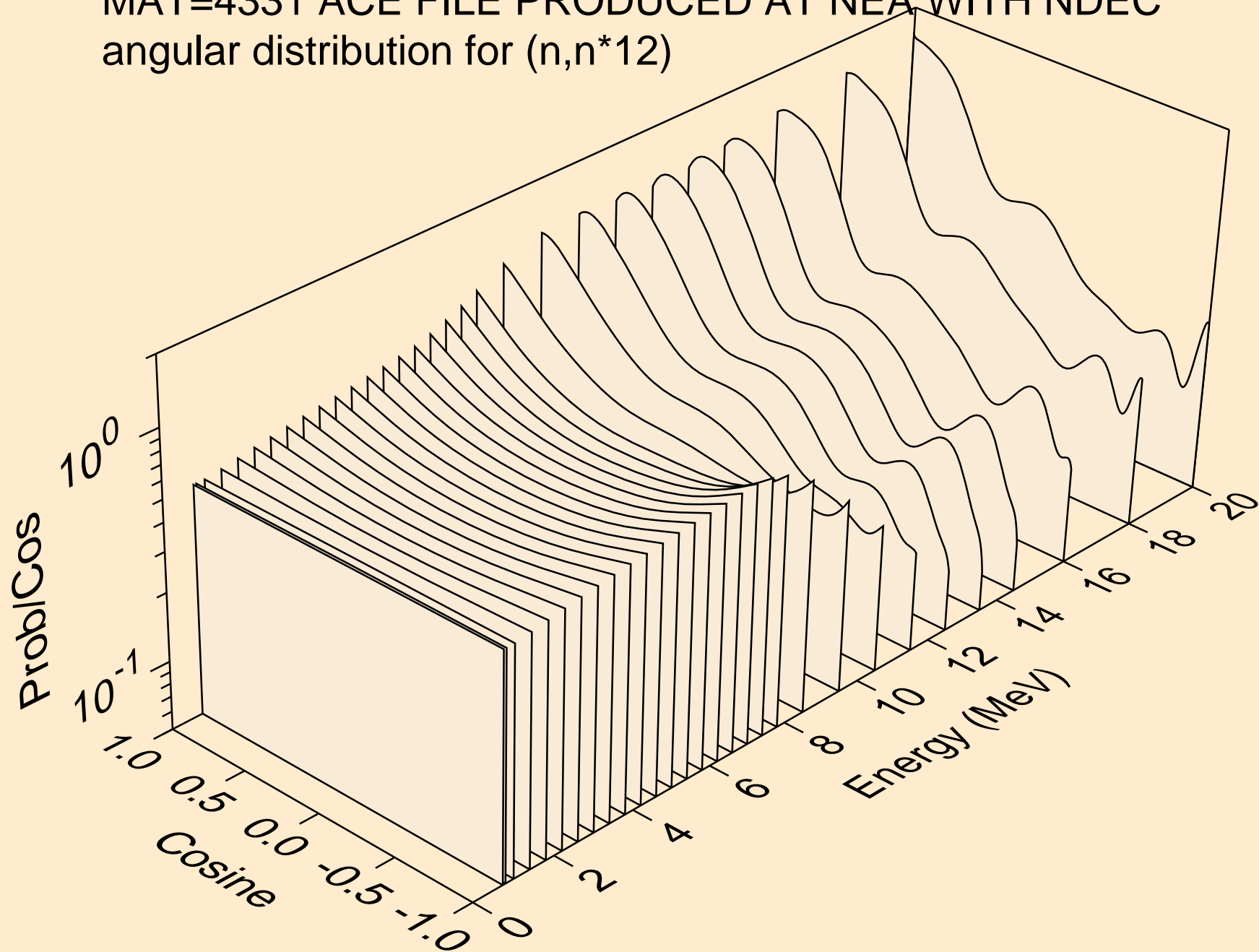

MAT=4331 ACE FILE PRODUCED AT NEA WITH NDEC
angular distribution for (n,n*13)

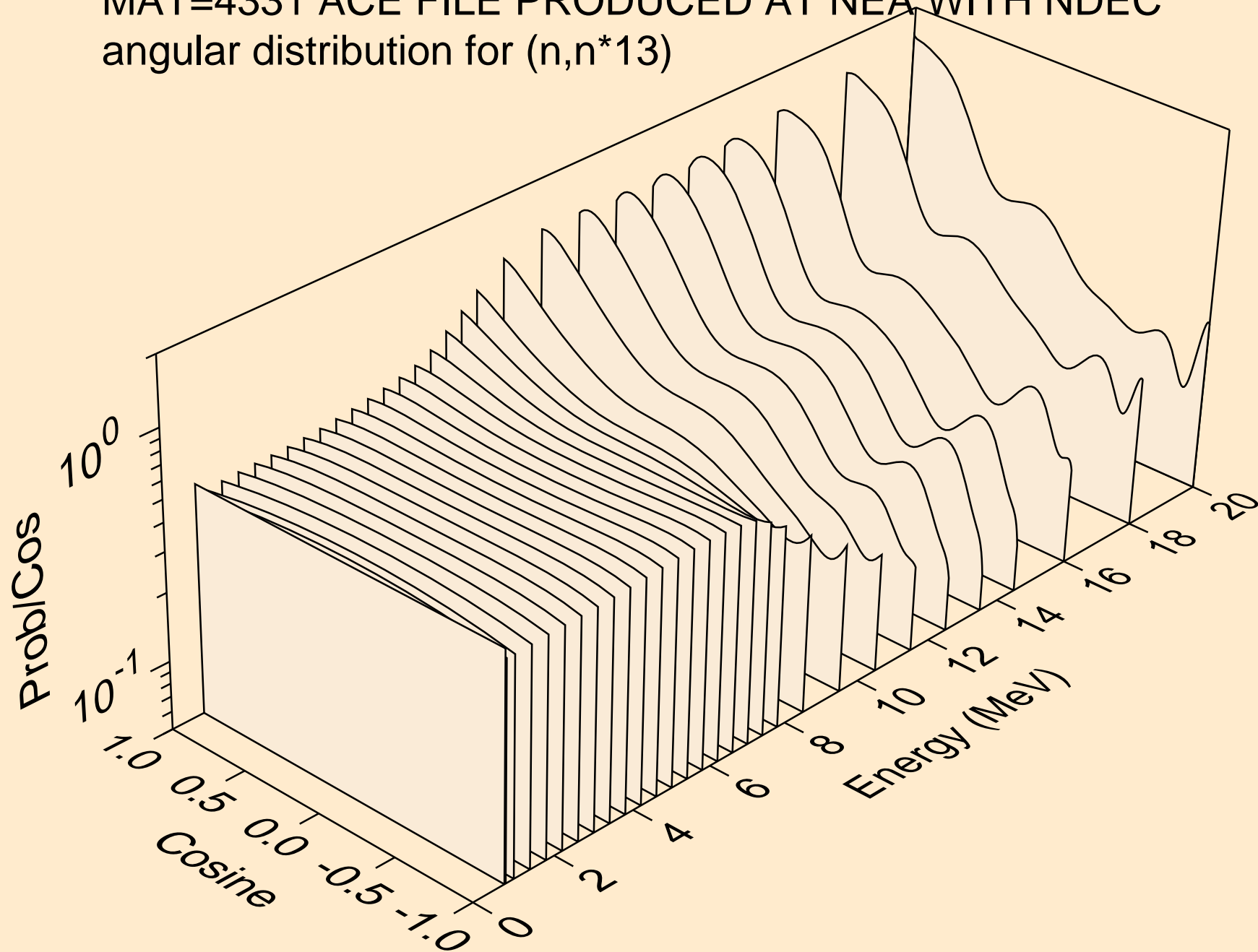

MAT=4331 ACE FILE PRODUCED AT NEA WITH NDEC
angular distribution for (n,n*14)

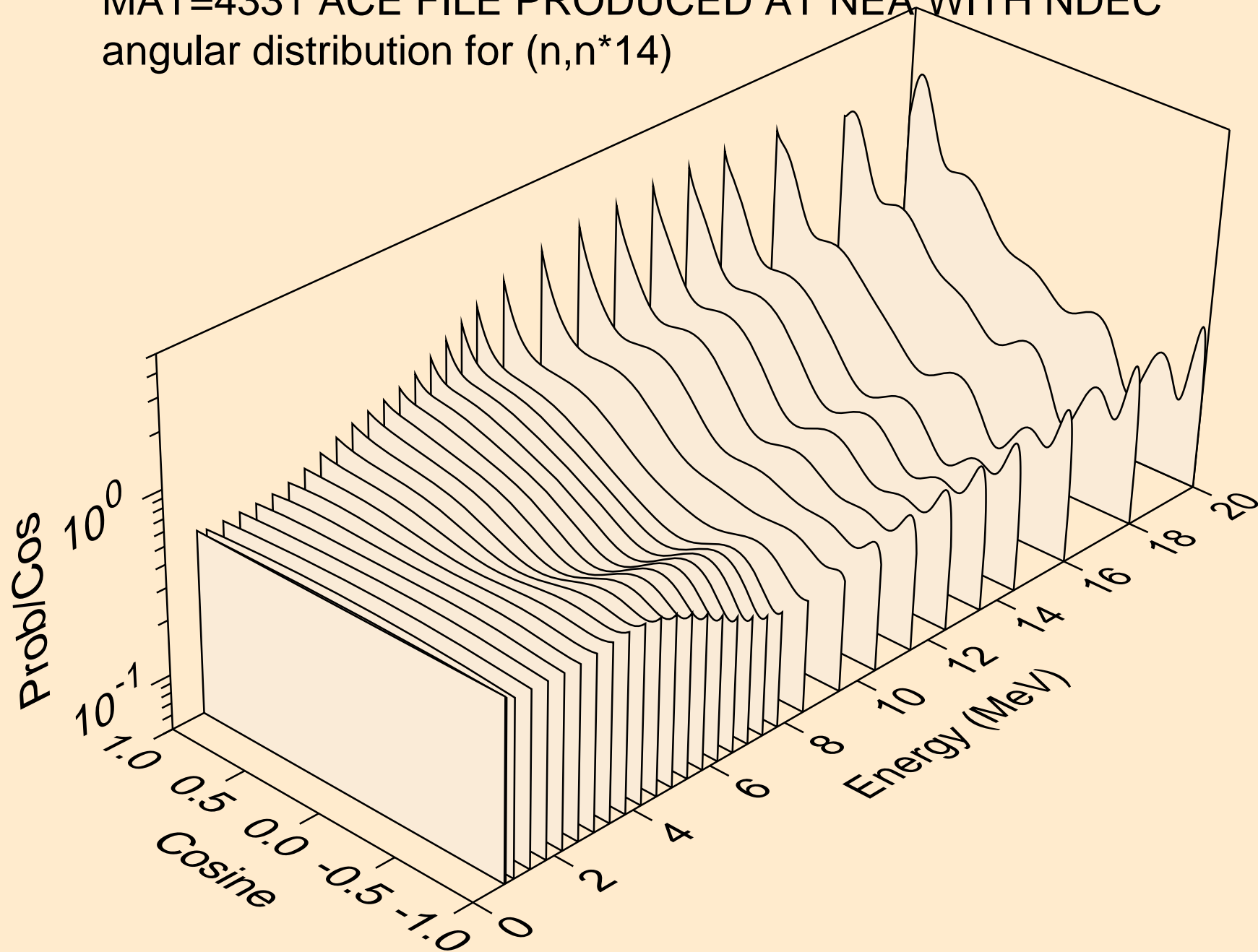

MAT=4331 ACE FILE PRODUCED AT NEA WITH NDEC
angular distribution for (n,n*15)

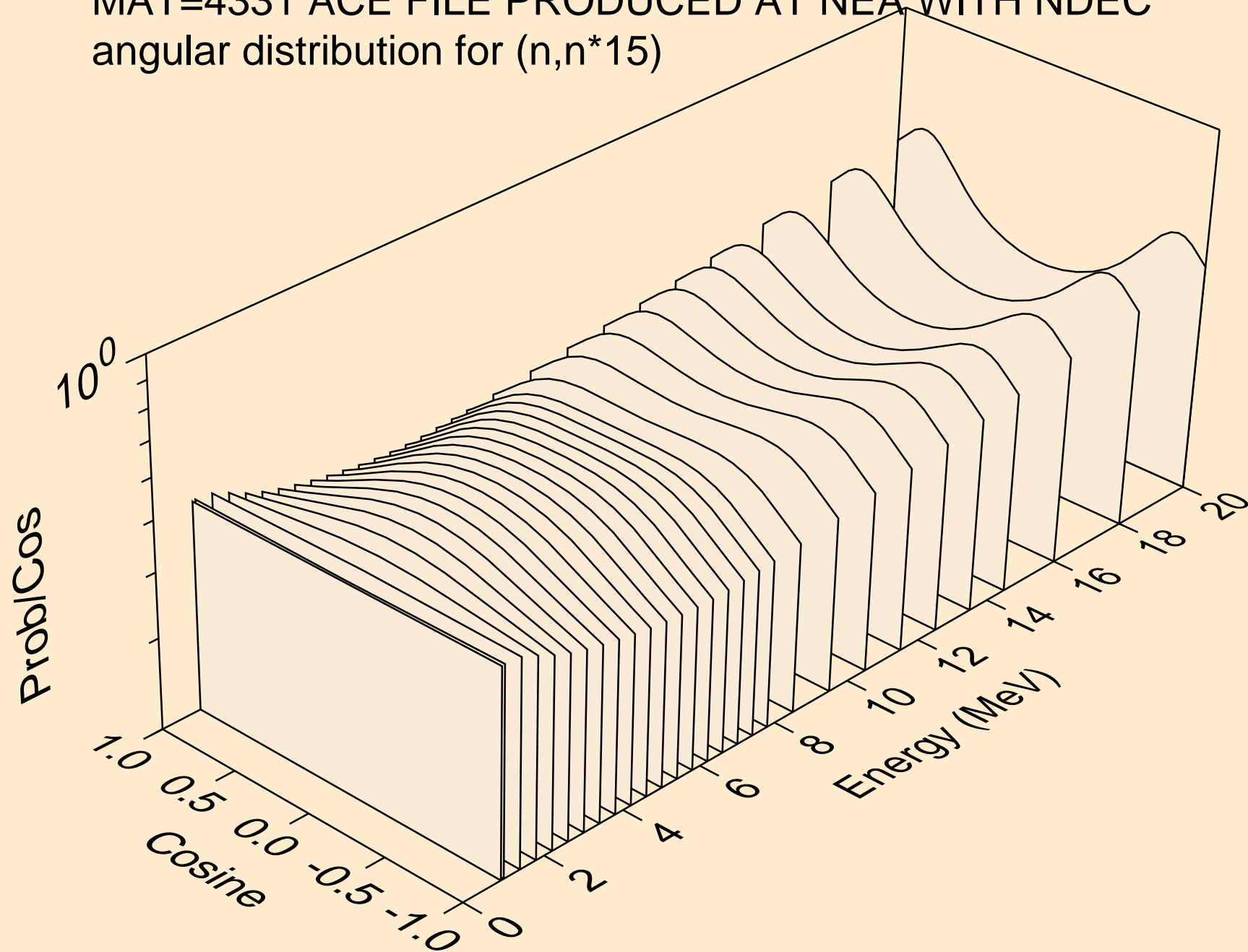

MAT=4331 ACE FILE PRODUCED AT NEA WITH NDEC
angular distribution for (n,n*16)

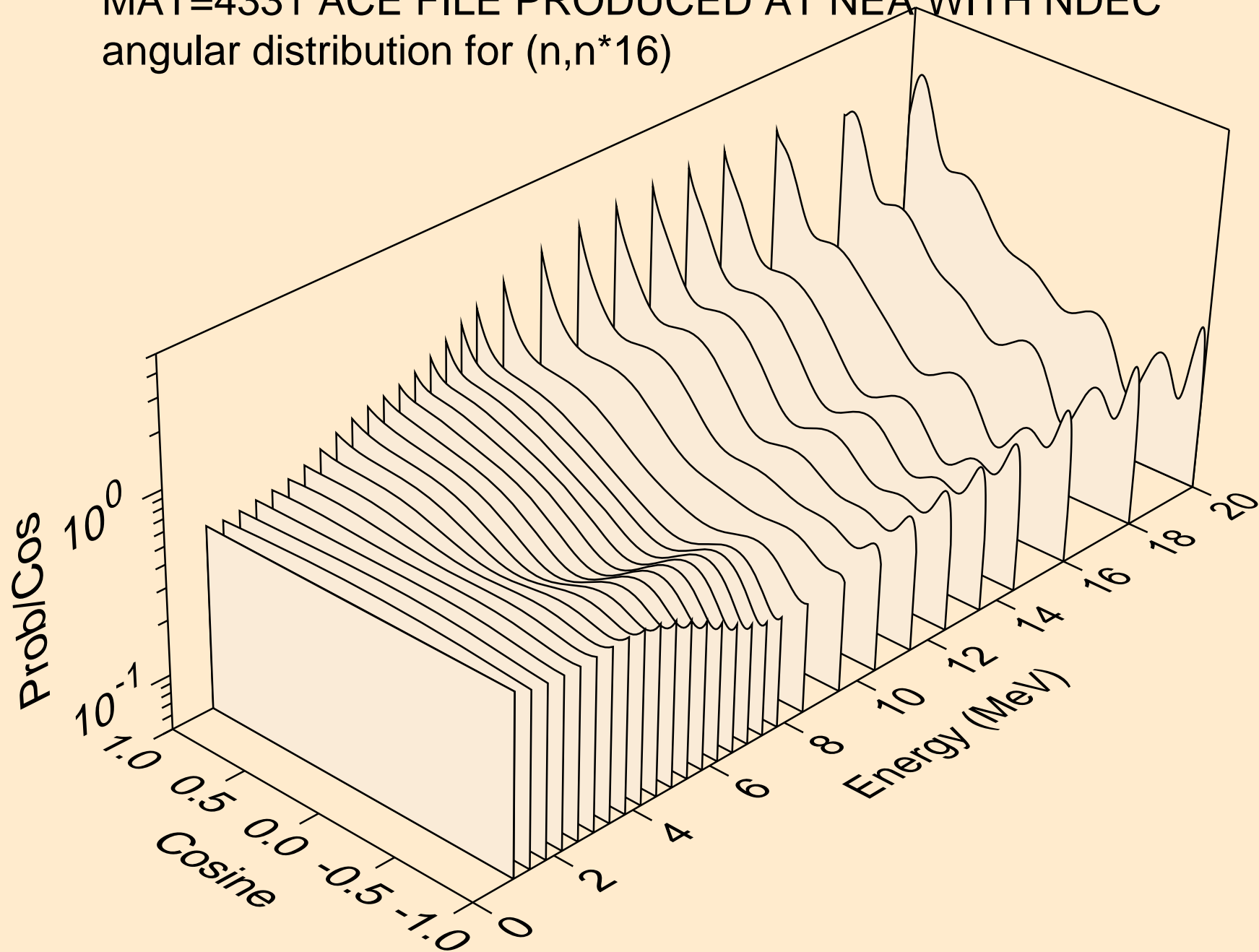

MAT=4331 ACE FILE PRODUCED AT NEA WITH NDEC
angular distribution for (n,n*17)

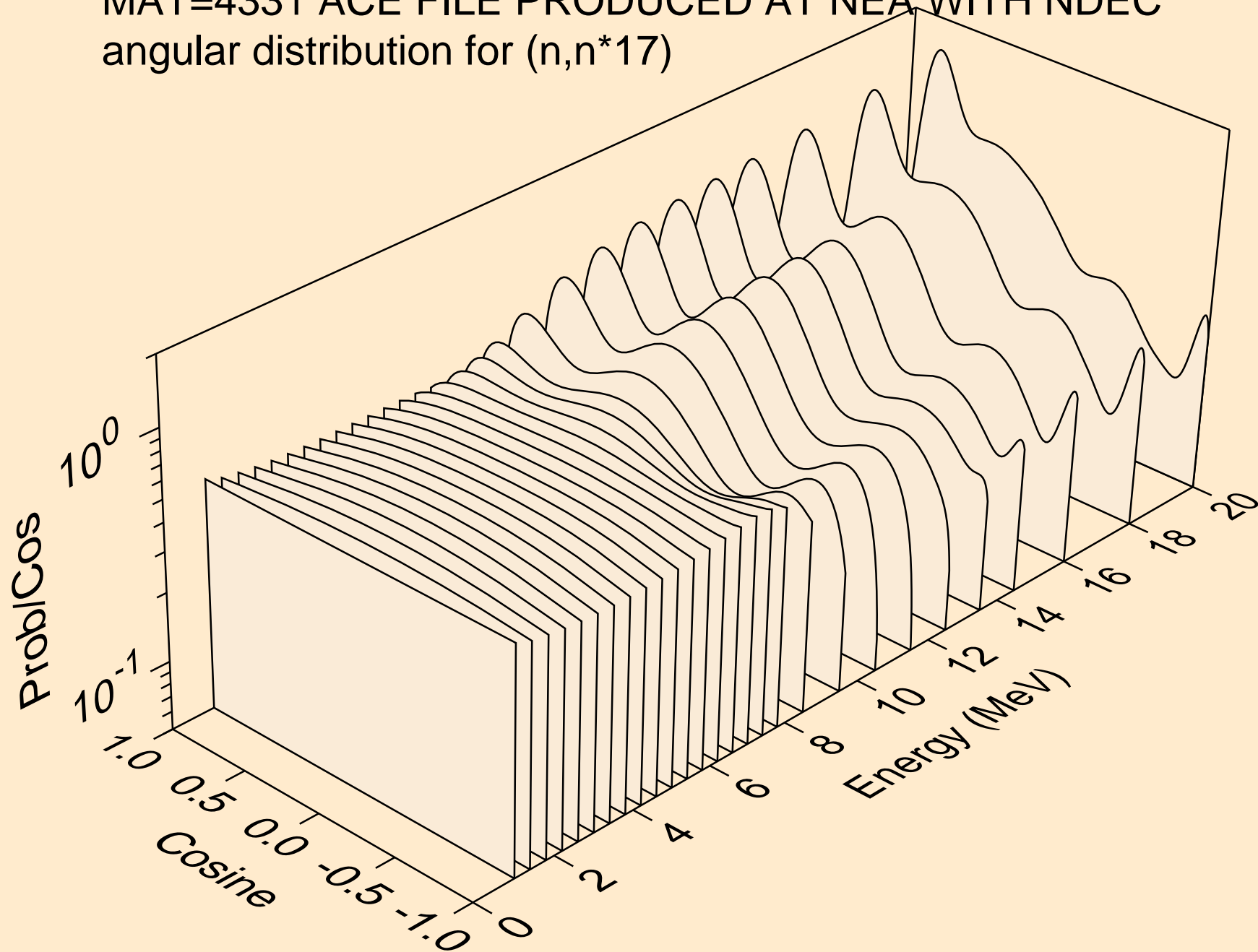

MAT=4331 ACE FILE PRODUCED AT NEA WITH NDEC
angular distribution for (n,n*18)

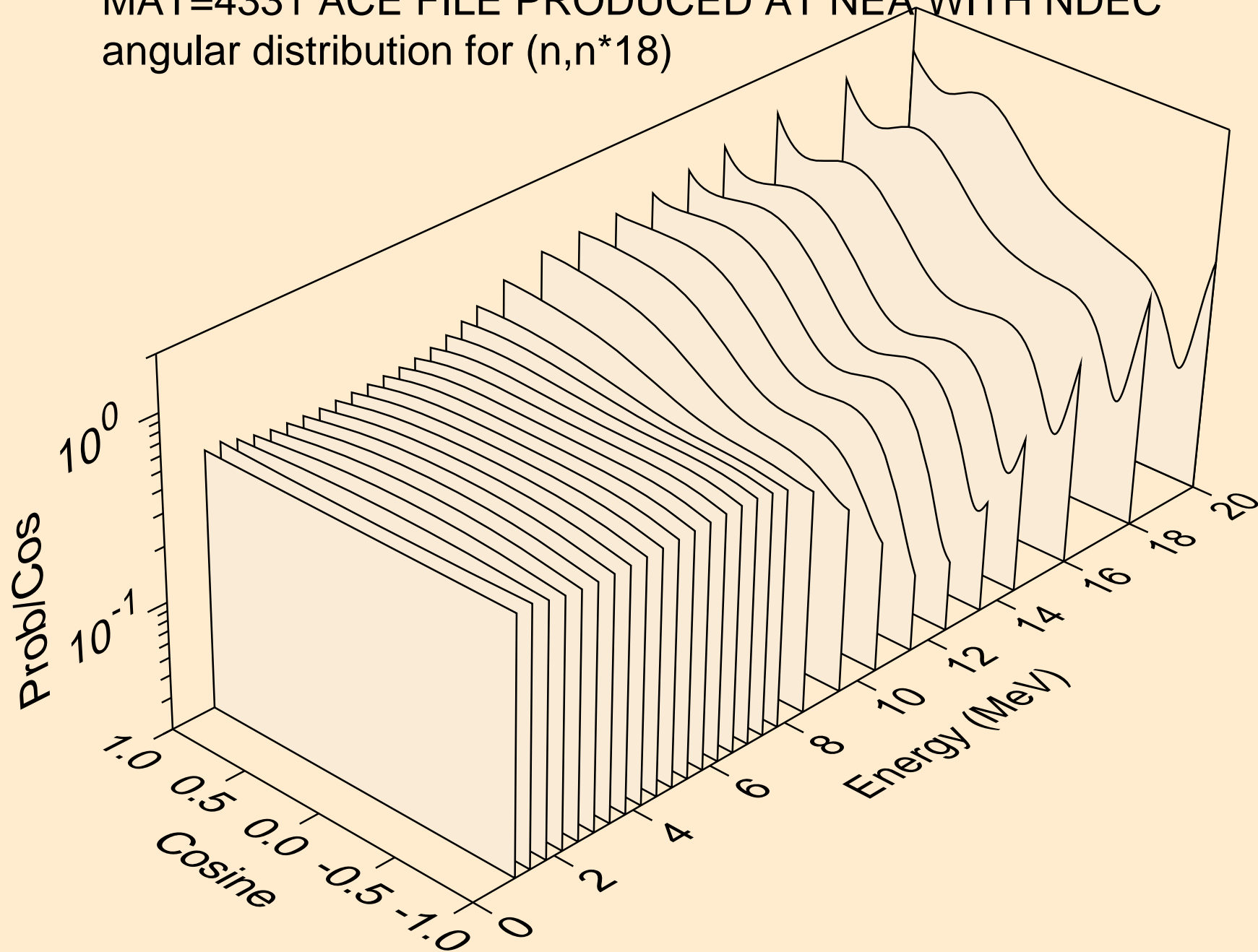

MAT=4331 ACE FILE PRODUCED AT NEA WITH NDEC
angular distribution for (n,n*19)

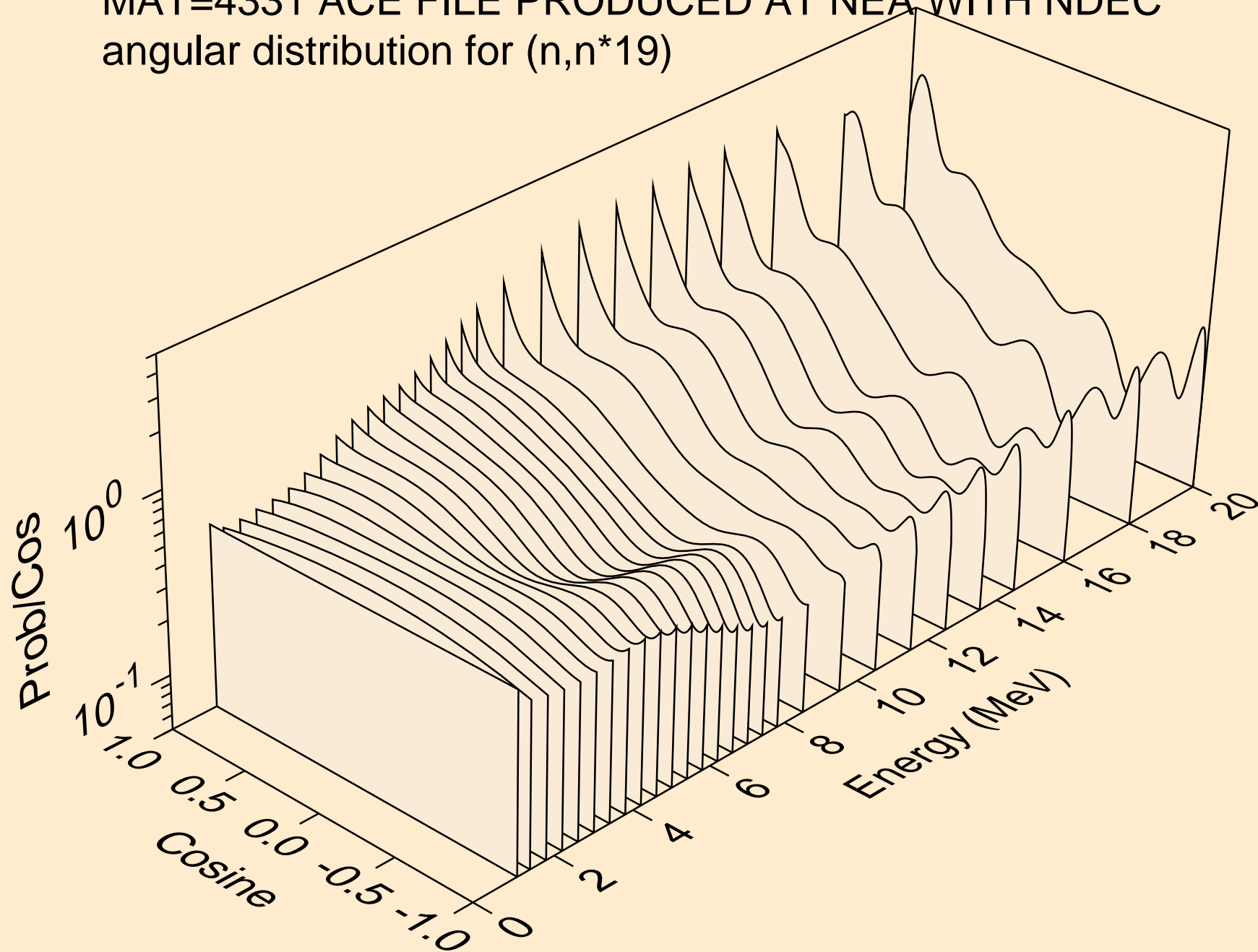

MAT=4331 ACE FILE PRODUCED AT NEA WITH NDEC
angular distribution for (n,n*20)

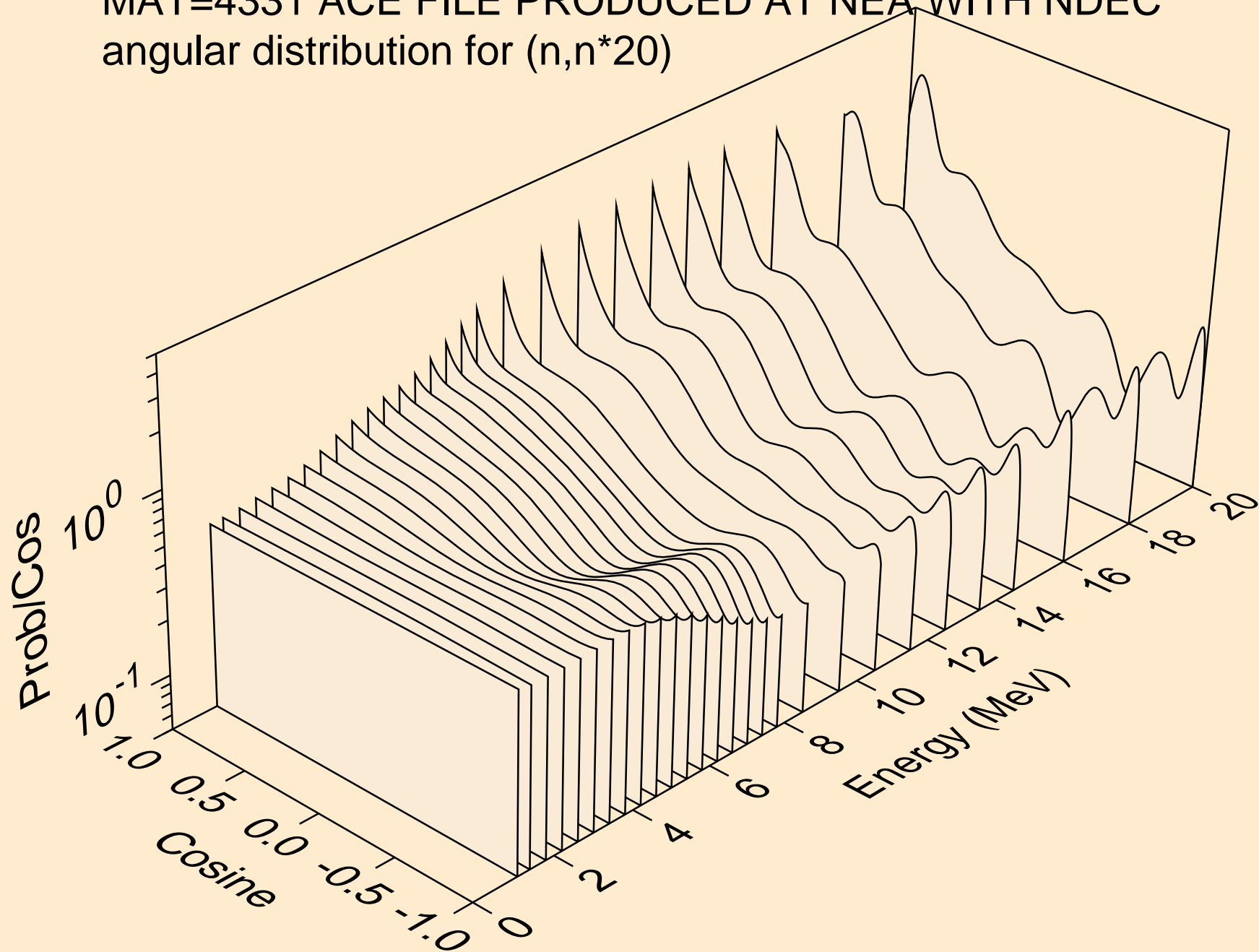

MAT=4331 ACE FILE PRODUCED AT NEA WITH NDEC
Neutron emission for (n,x)

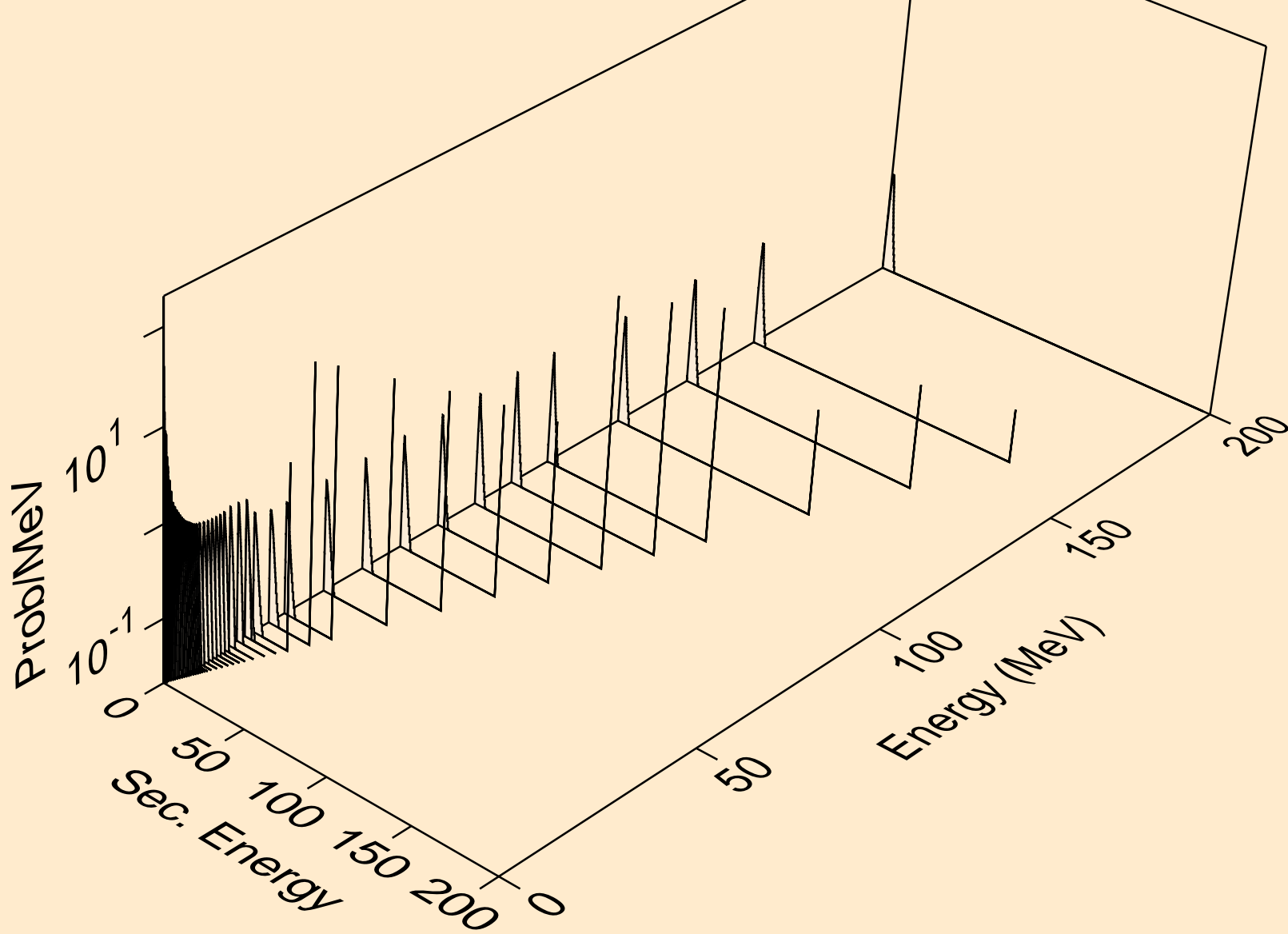

MAT=4331 ACE FILE PRODUCED AT NEA WITH NDEC
Neutron emission for (n,2n)

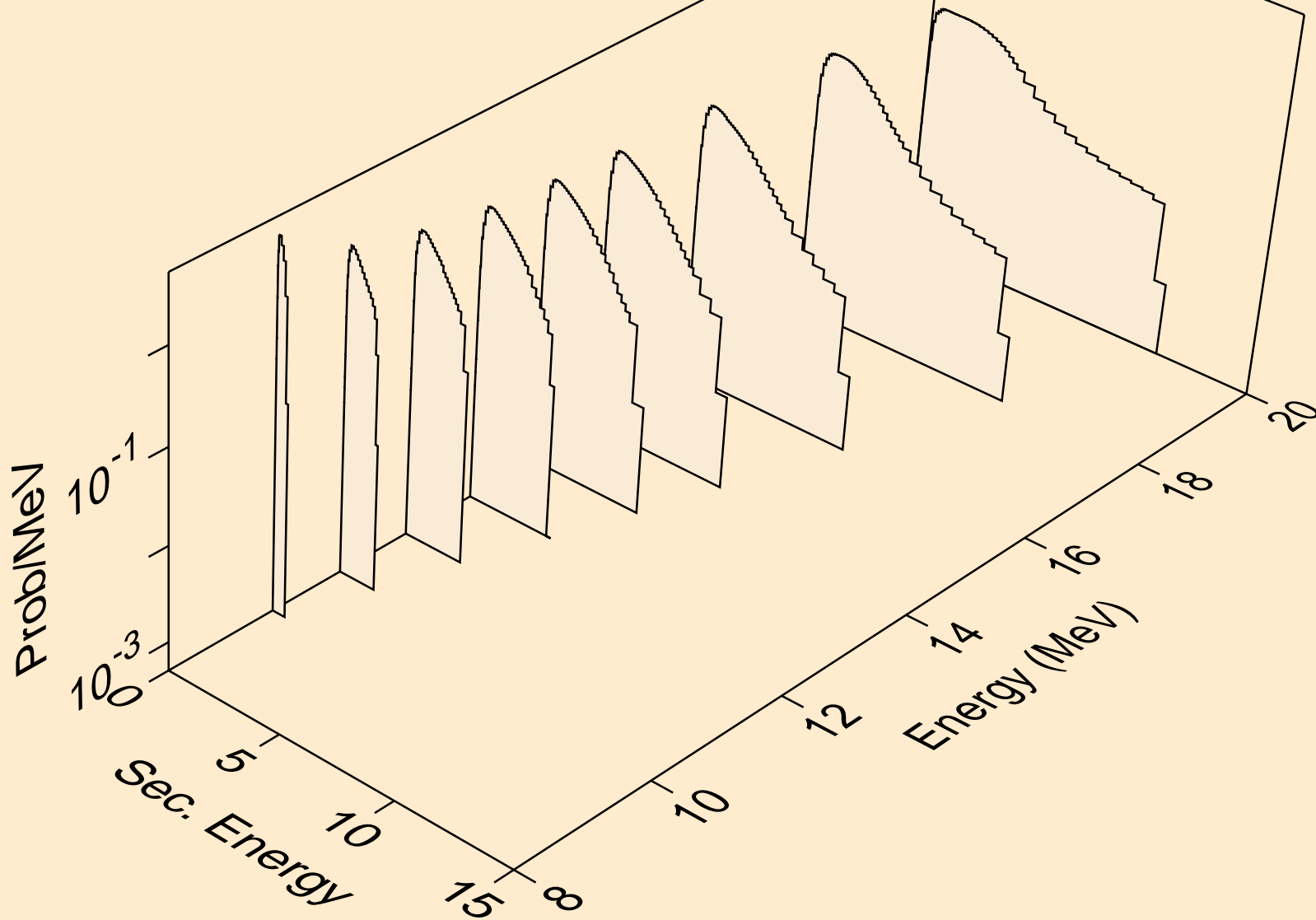

MAT=4331 ACE FILE PRODUCED AT NEA WITH NDEC
Neutron emission for (n,3n)

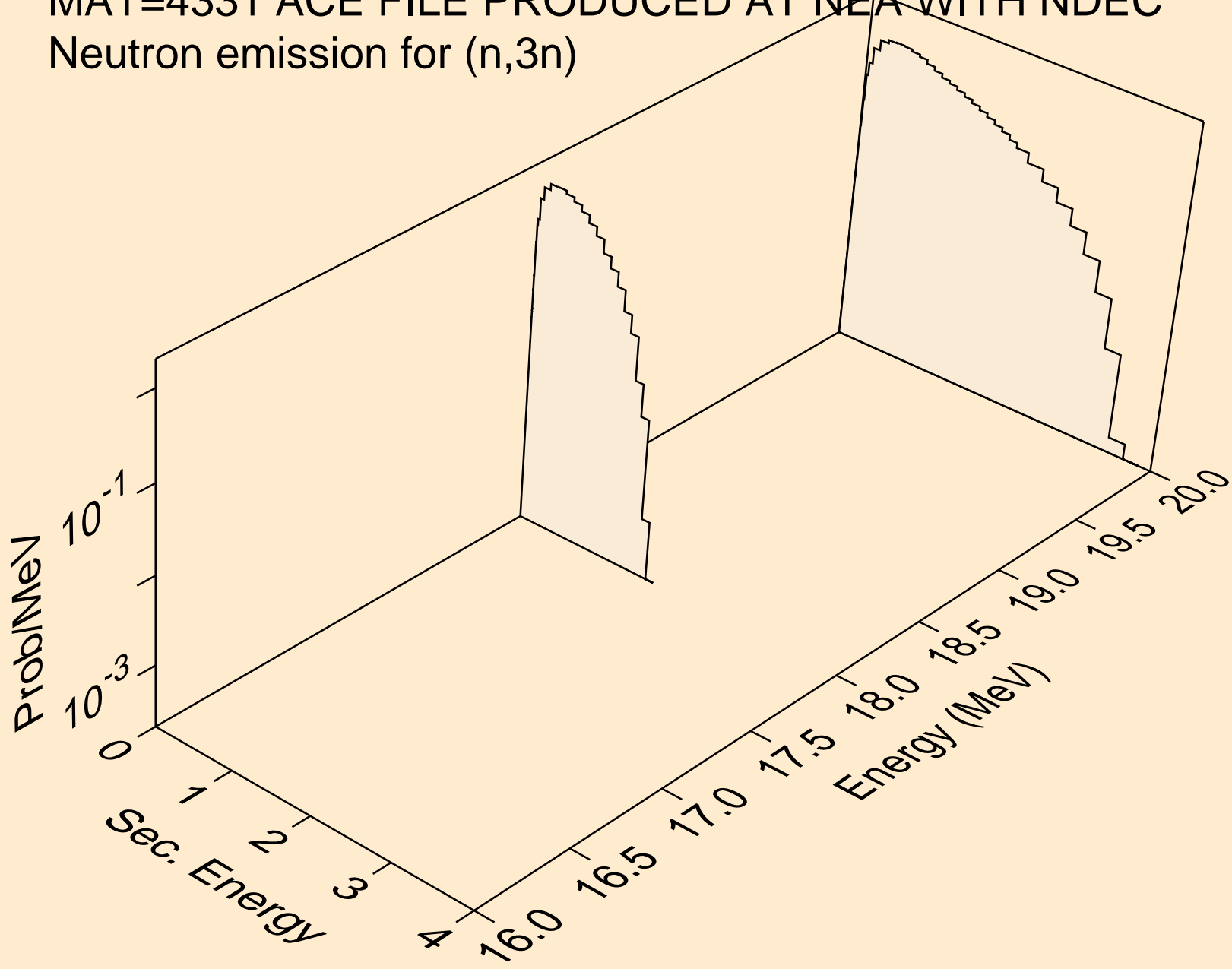

MAT=4331 ACE FILE PRODUCED AT NEA WITH NDEC
Neutron emission for (n,n*)a

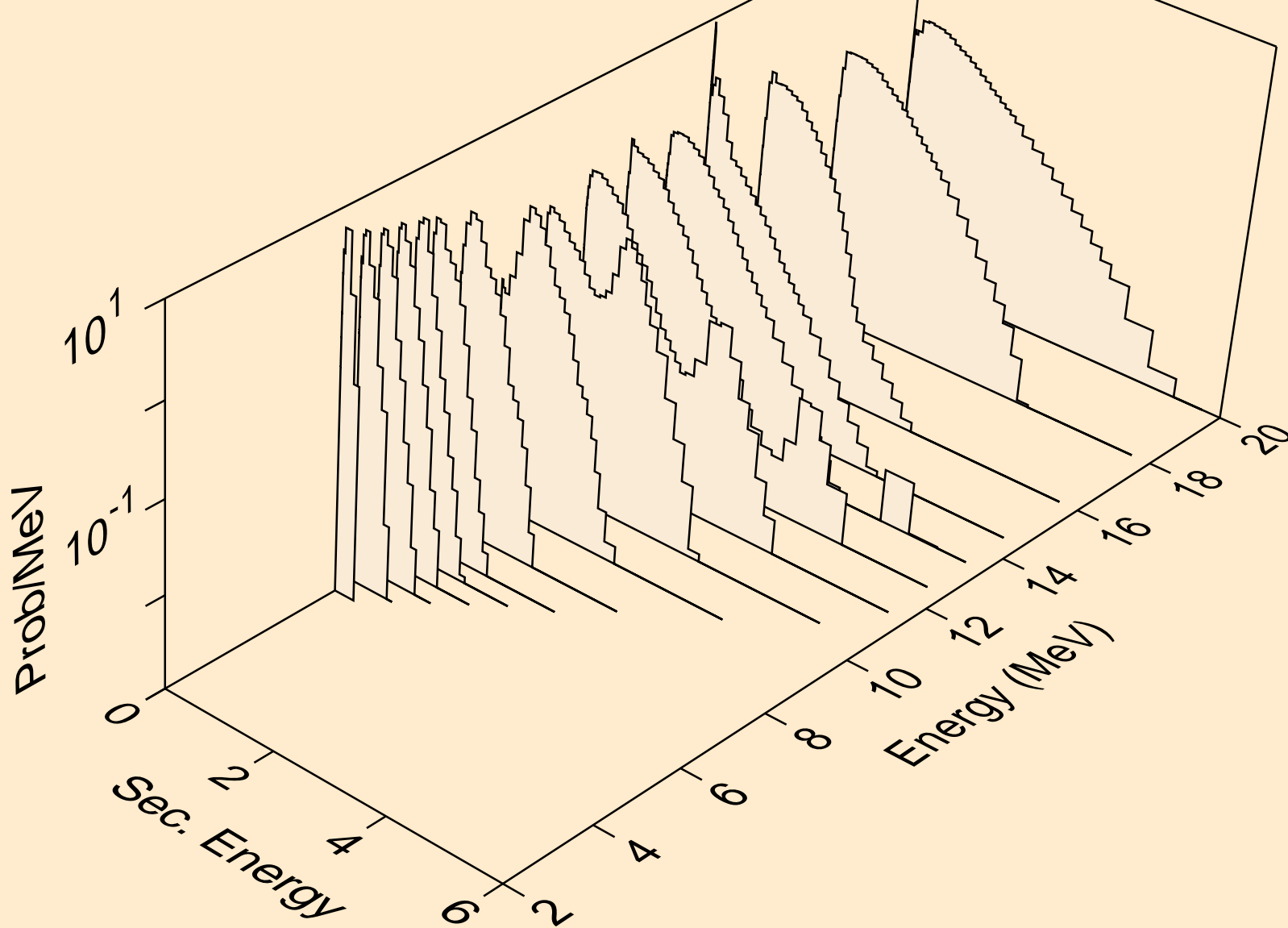

MAT=4331 ACE FILE PRODUCED AT NEA WITH NDEC
Neutron emission for (n,2n)a

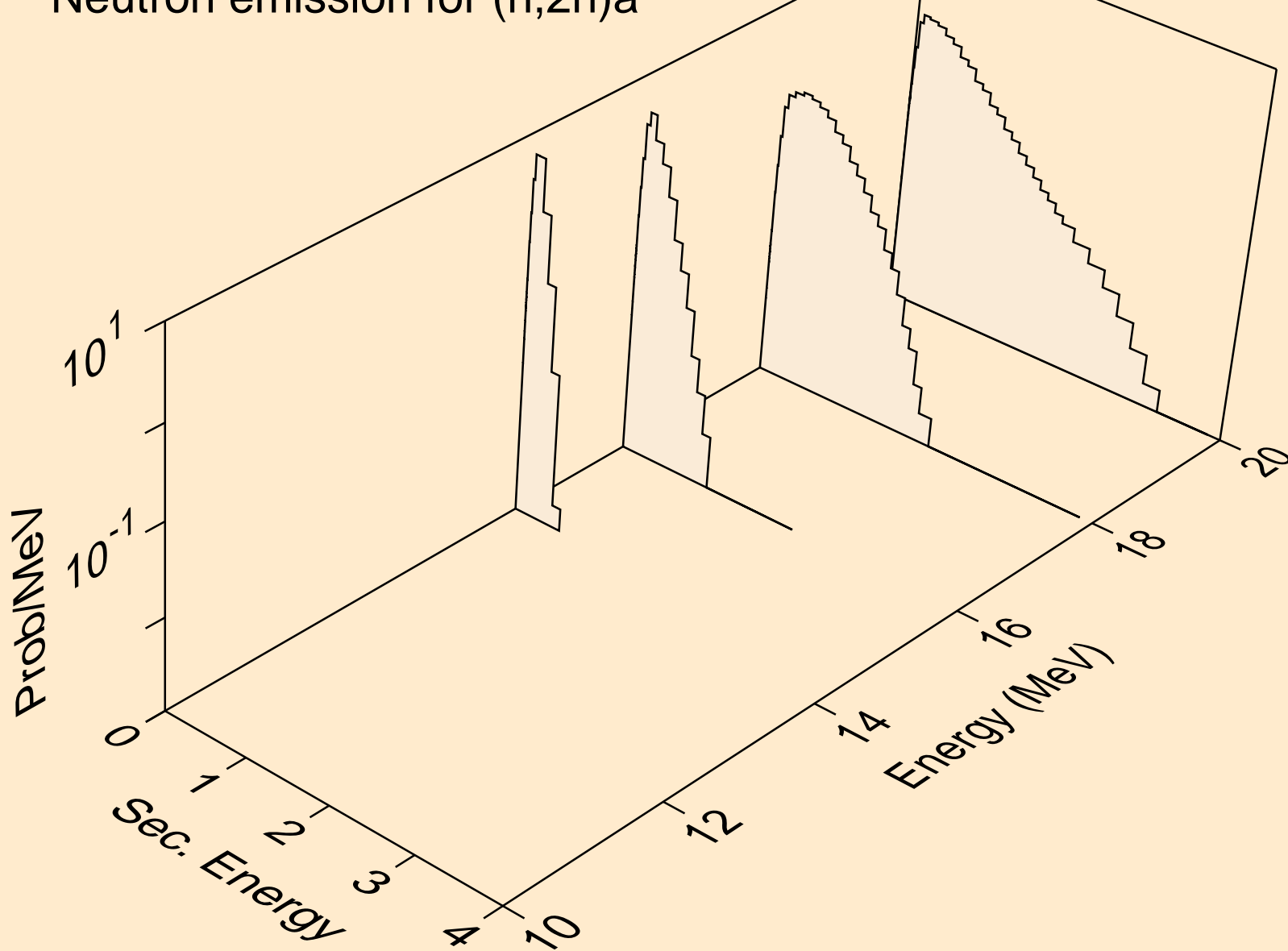

MAT=4331 ACE FILE PRODUCED AT NEA WITH NDEC
Neutron emission for (n,n*)p

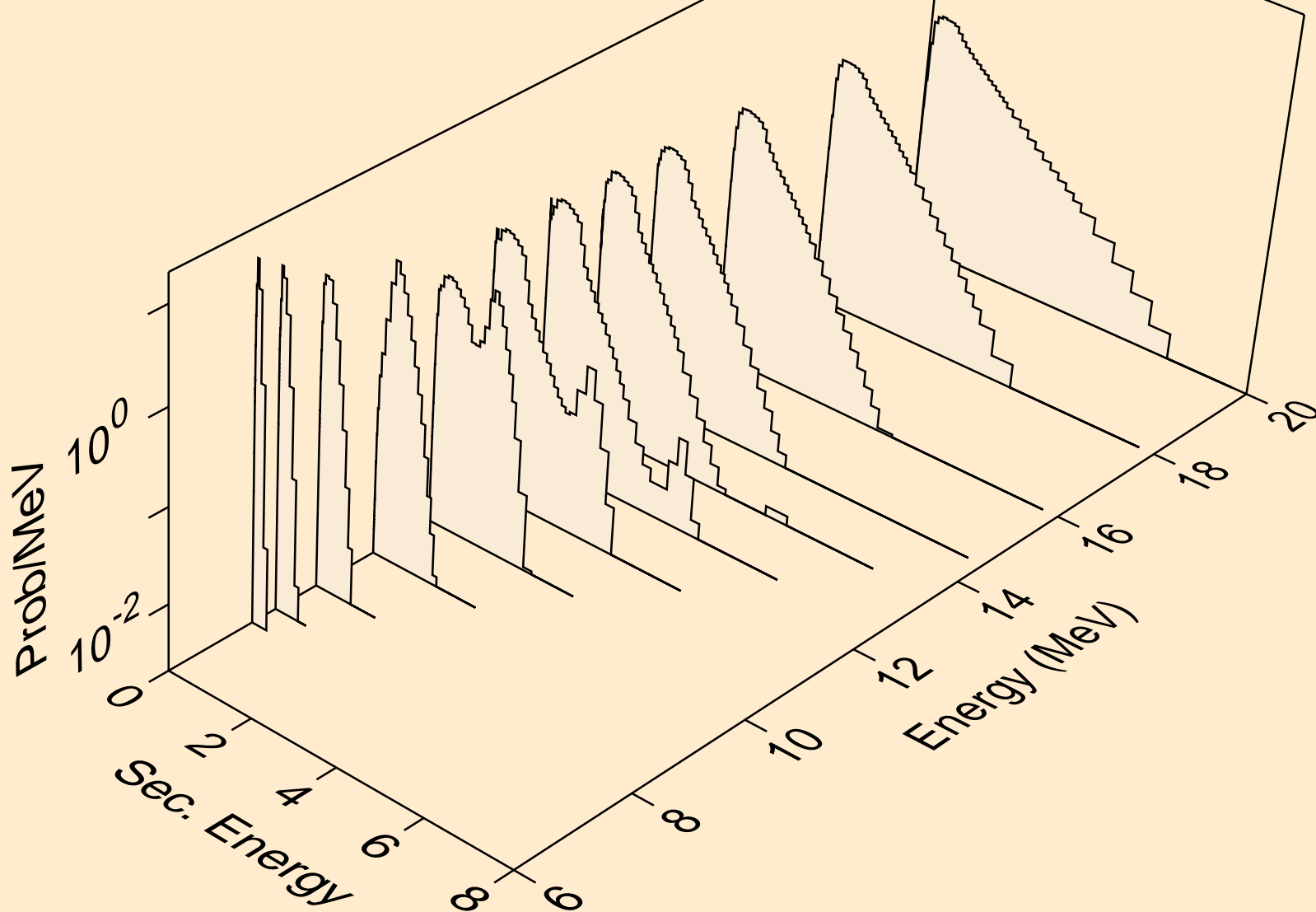

MAT=4331 ACE FILE PRODUCED AT NEA WITH NDEC
Neutron emission for (n,n*)d

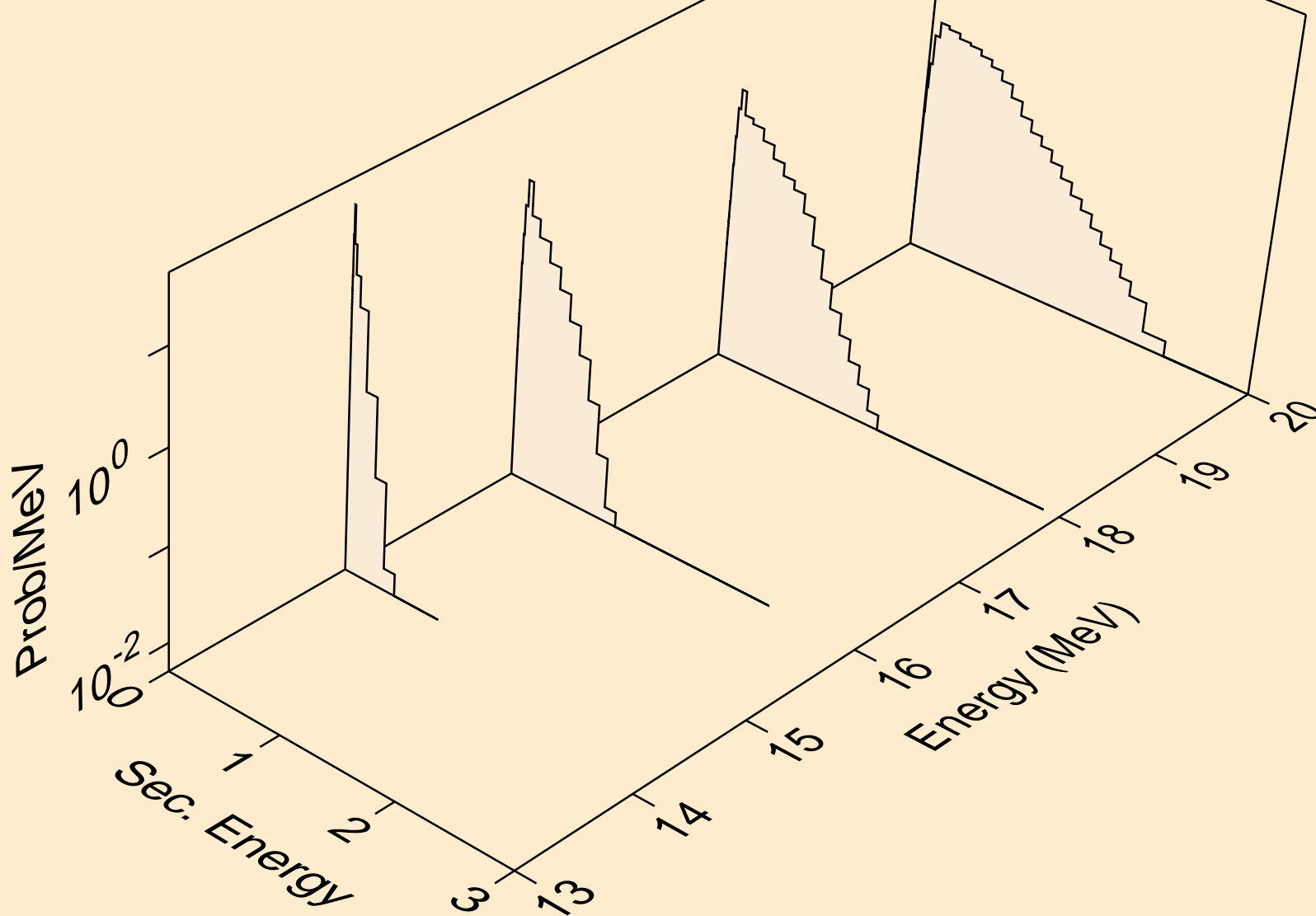

MAT=4331 ACE FILE PRODUCED AT NEA WITH NDEC
Neutron emission for (n,n*)t

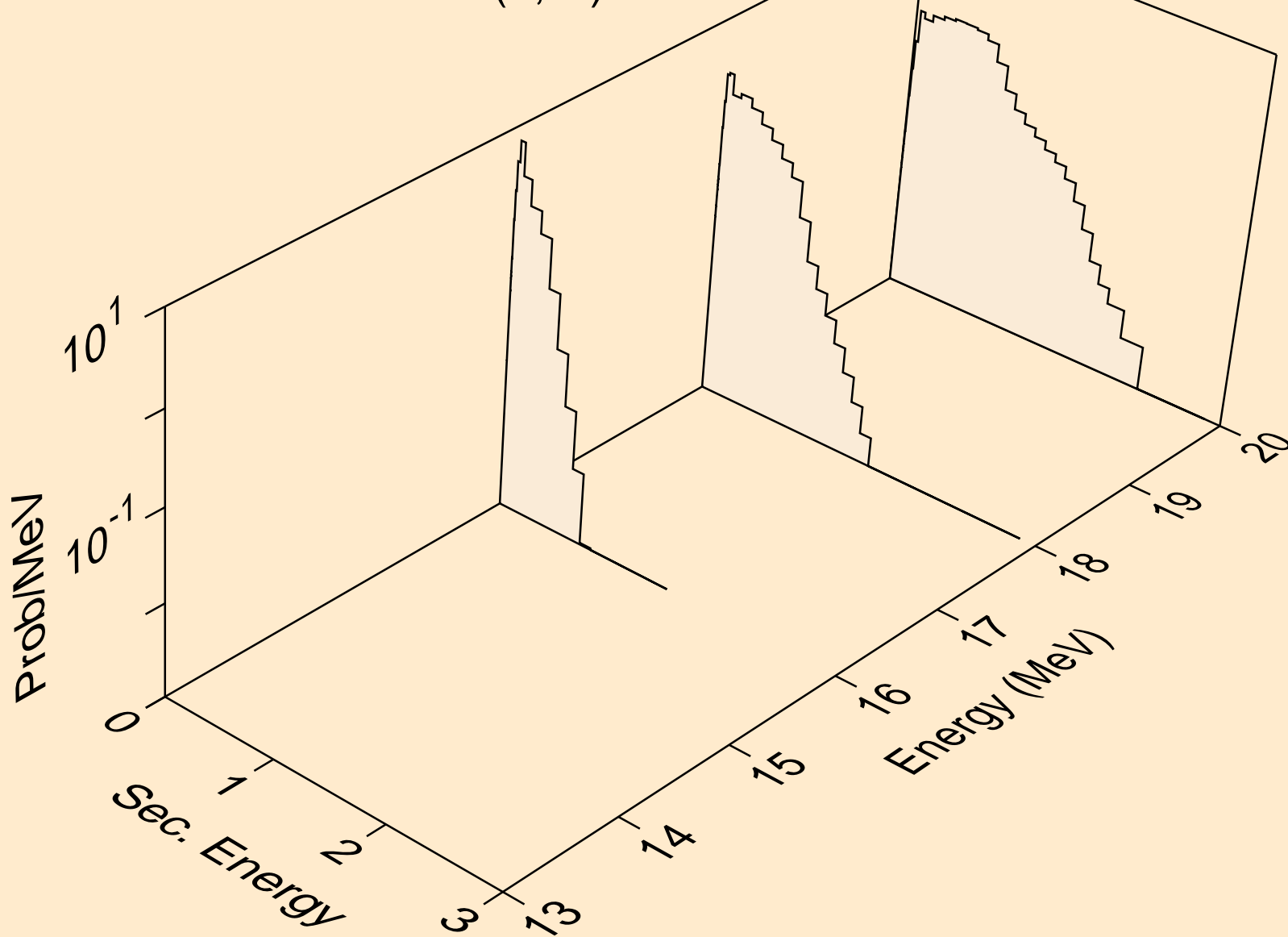

MAT=4331 ACE FILE PRODUCED AT NEA WITH NDEC
Neutron emission for (n,2np)

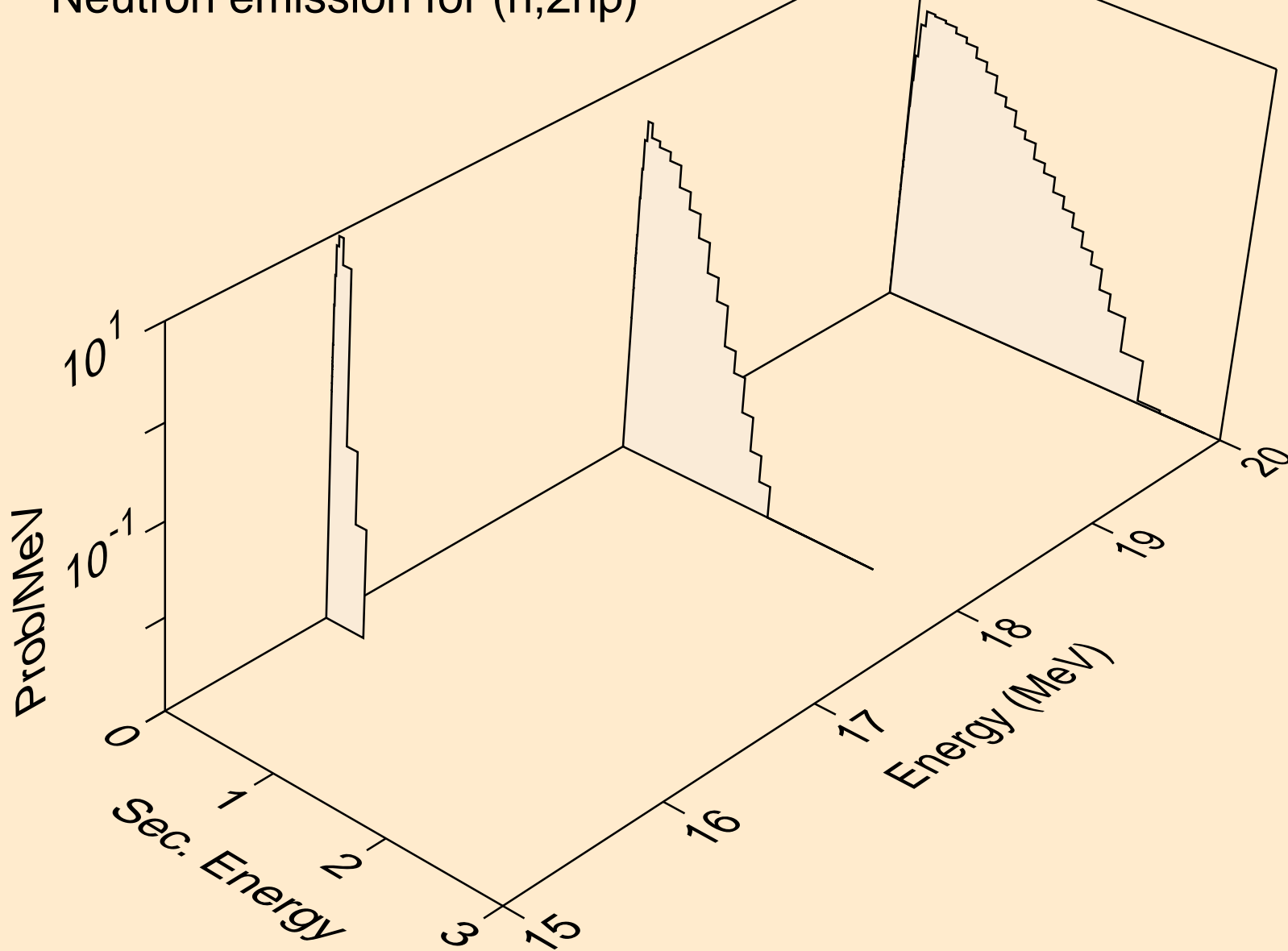

MAT=4331 ACE FILE PRODUCED AT NEA WITH NDEC
Neutron emission for (n,n*c)

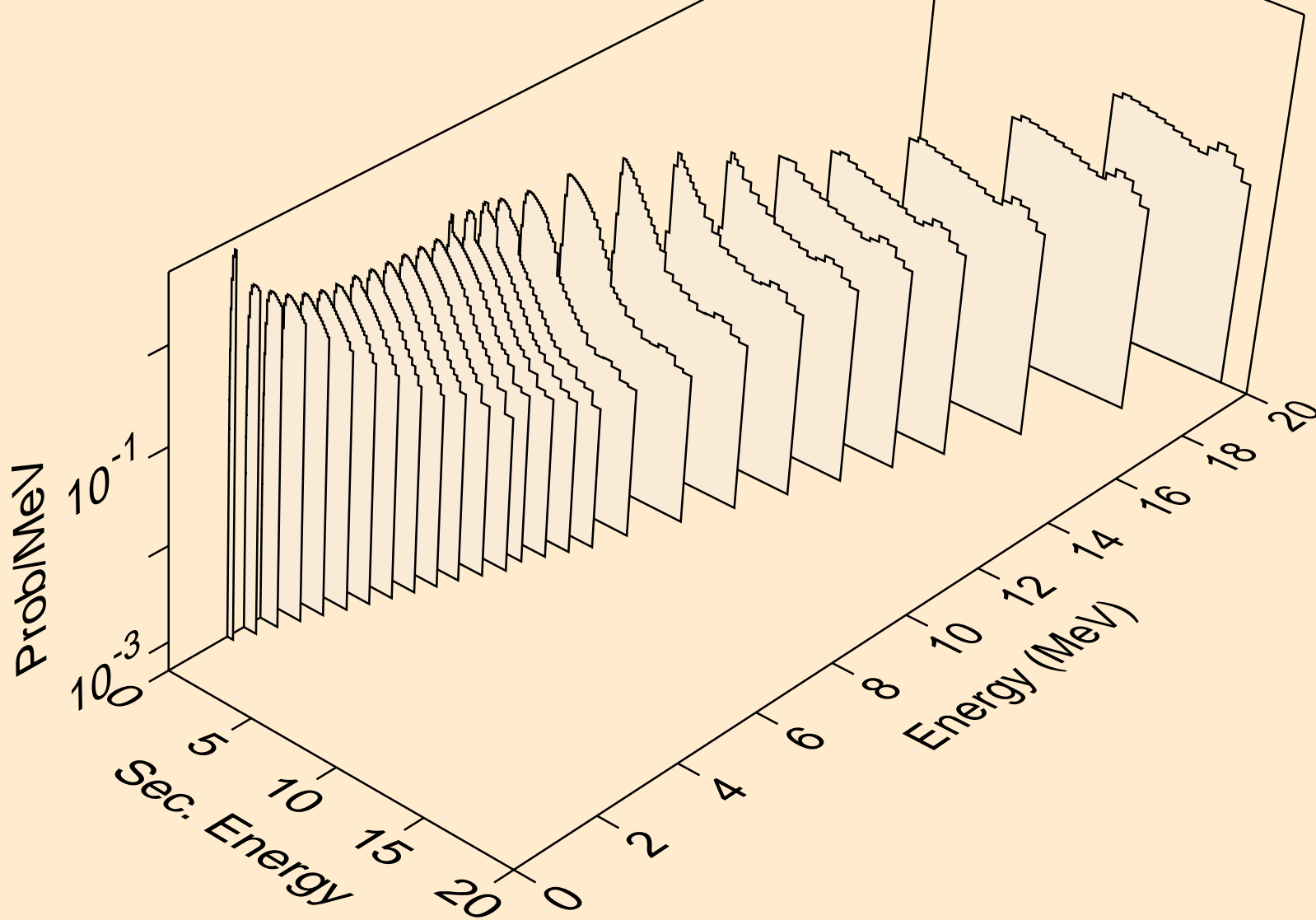

MAT=4331 ACE FILE PRODUCED AT NEA WITH NDEC
Photon emission for (n,x)

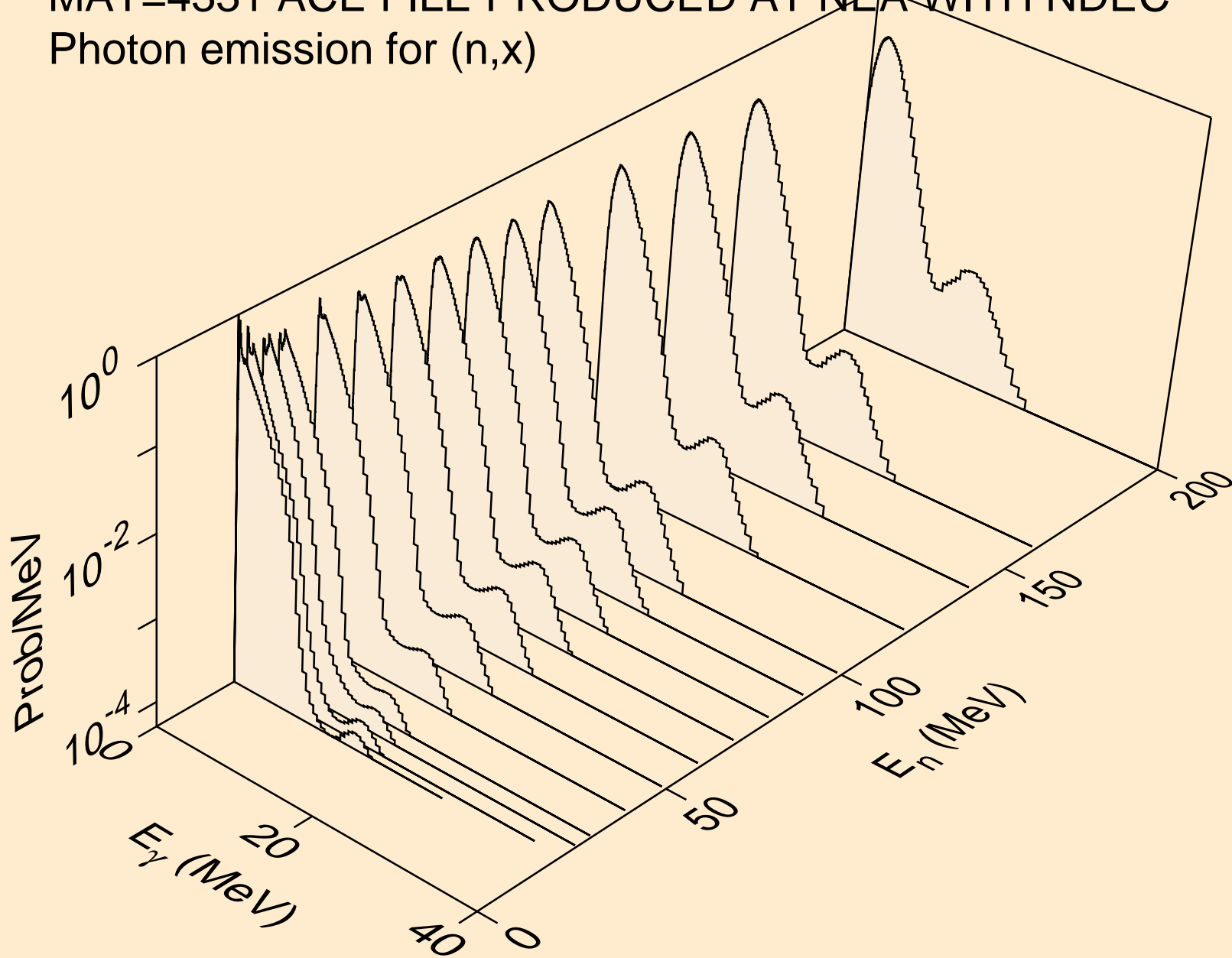

MAT=4331 ACE FILE PRODUCED AT NEA WITH NDEC
Photon emission for (n,2n)

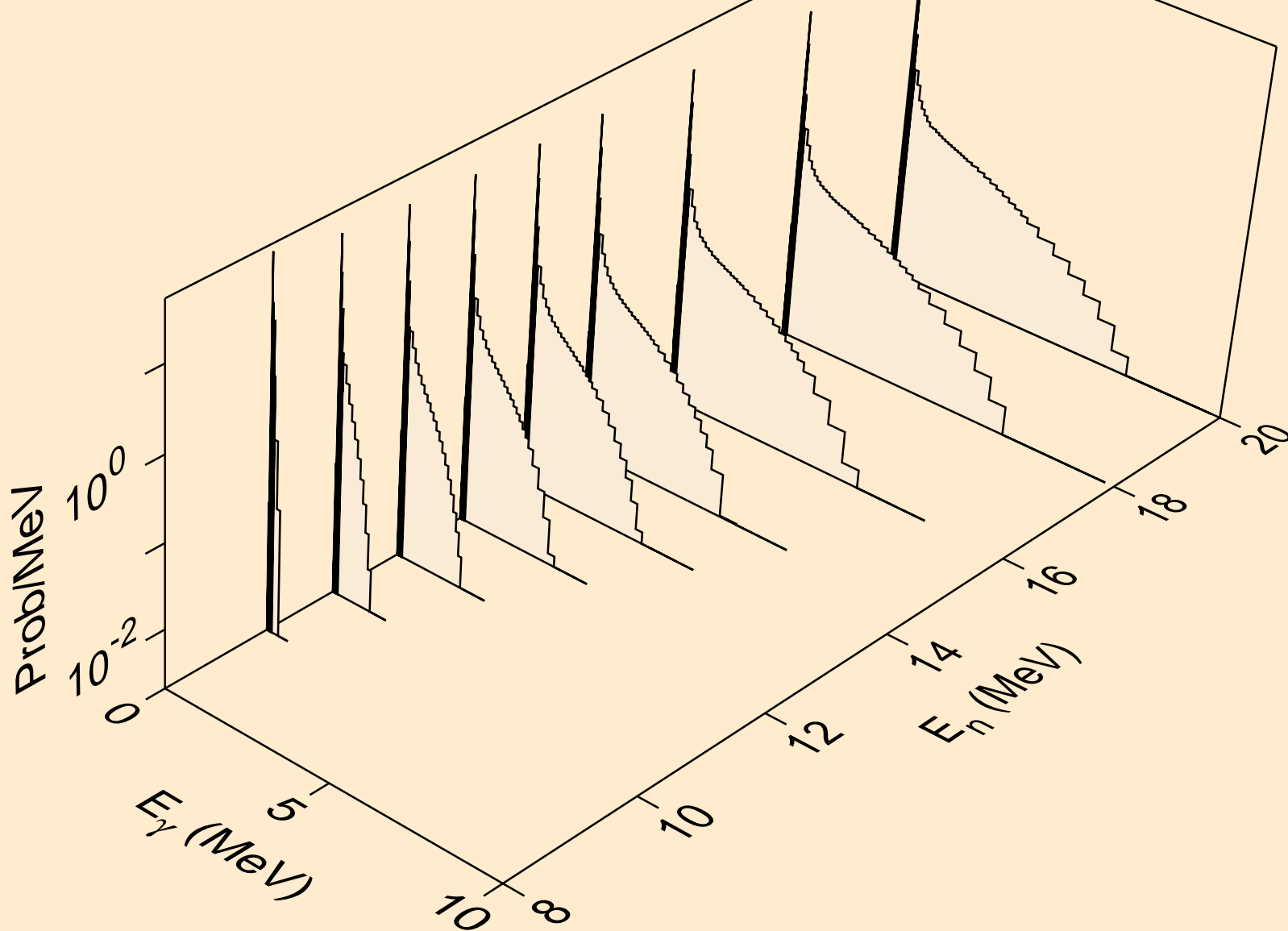

MAT=4331 ACE FILE PRODUCED AT NEA WITH NDEC
Photon emission for (n,3n)

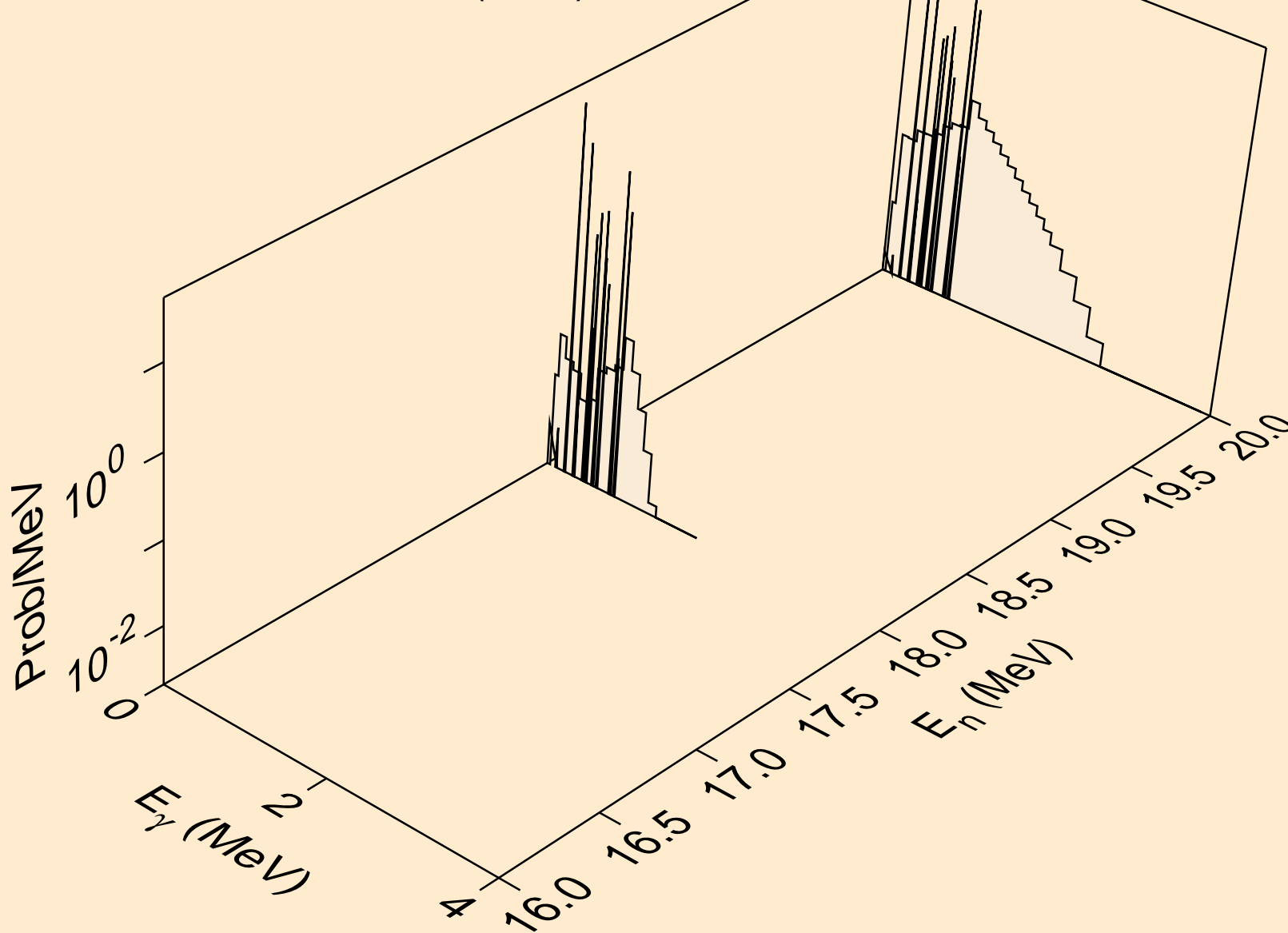

MAT=4331 ACE FILE PRODUCED AT NEA WITH NDEC
Photon emission for (n,n*)a

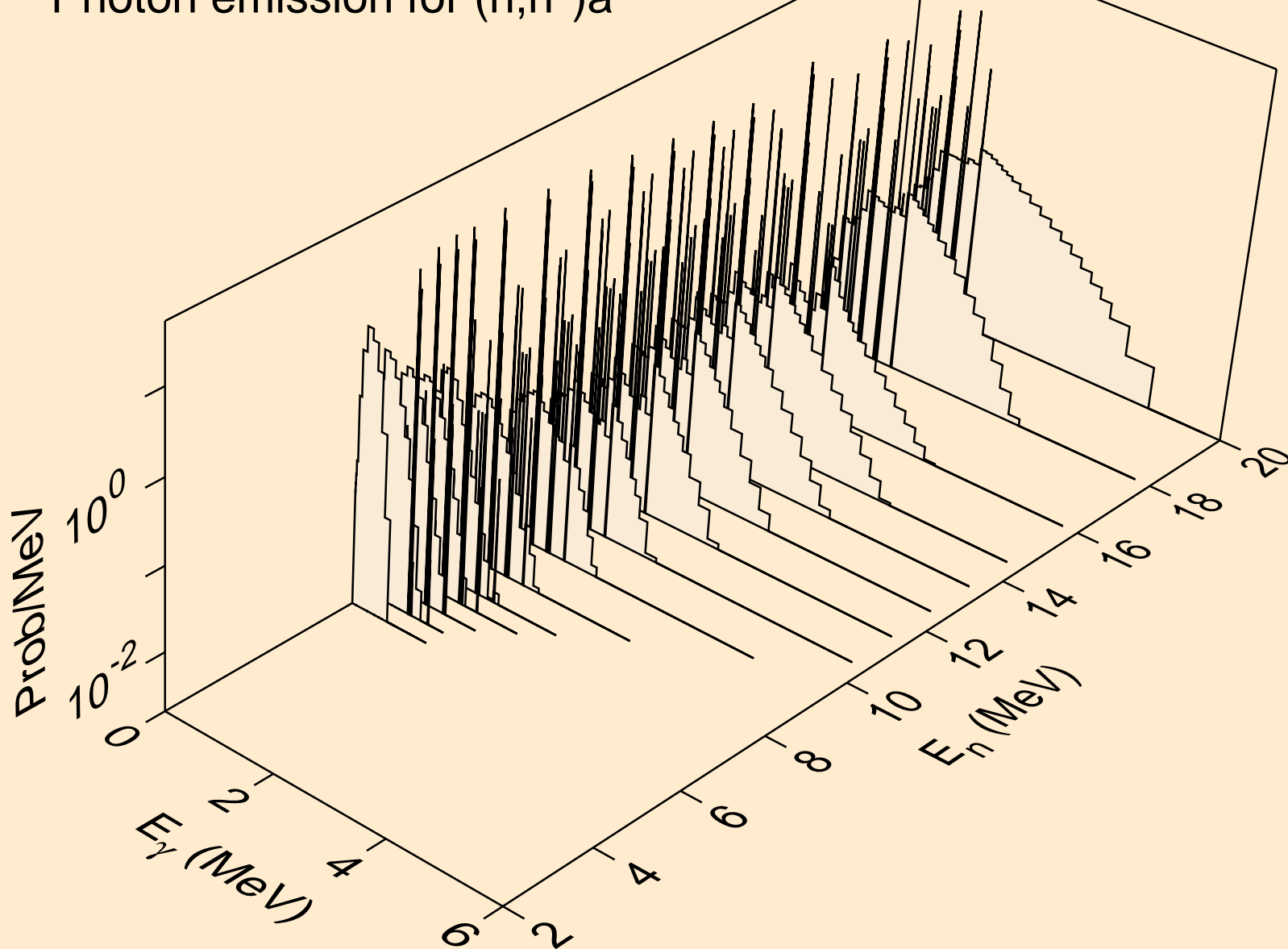

MAT=4331 ACE FILE PRODUCED AT NEA WITH NDEC
Photon emission for (n,2n)a

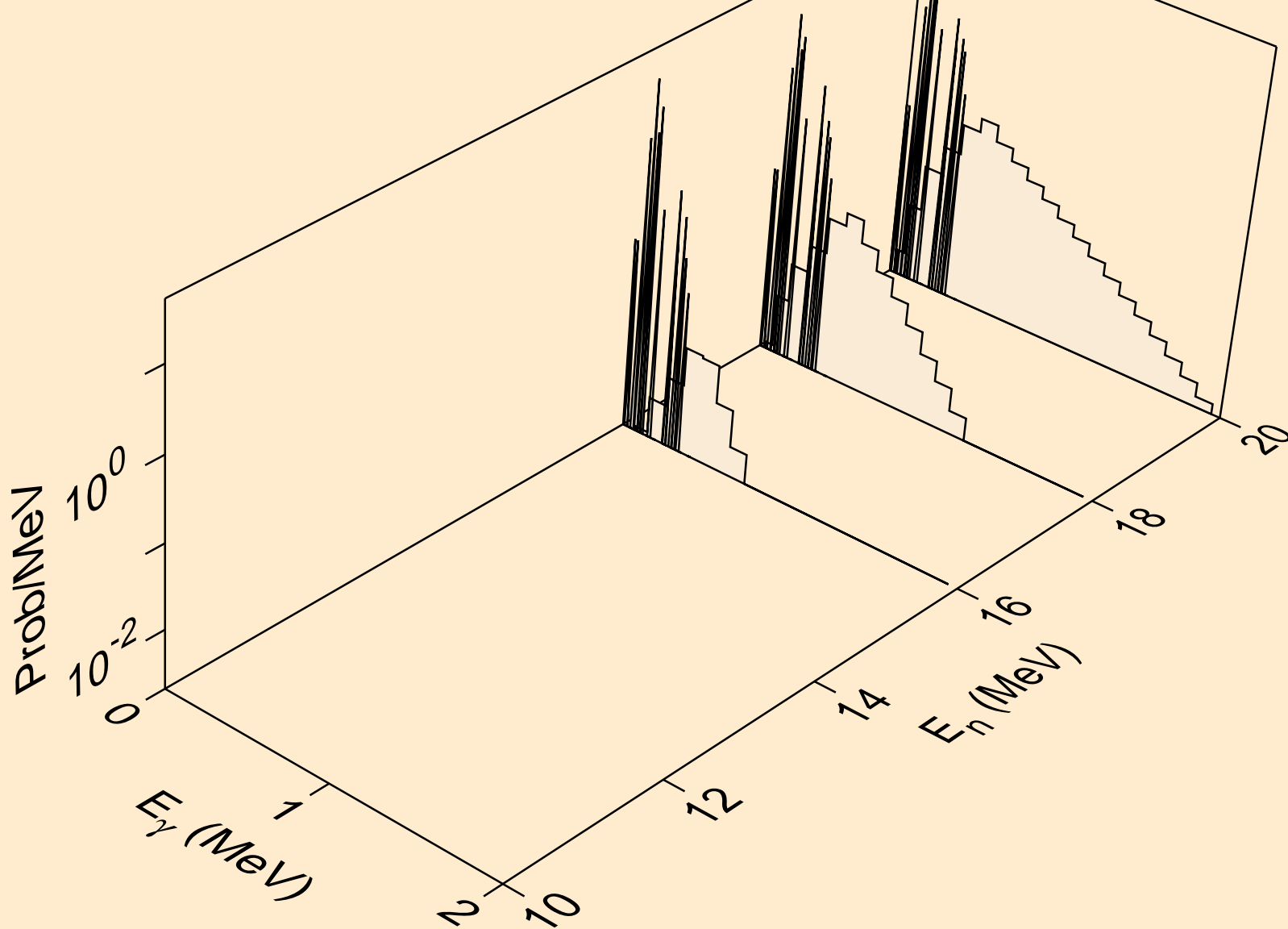

MAT=4331 ACE FILE PRODUCED AT NEA WITH NDEC
Photon emission for (n,n*)p

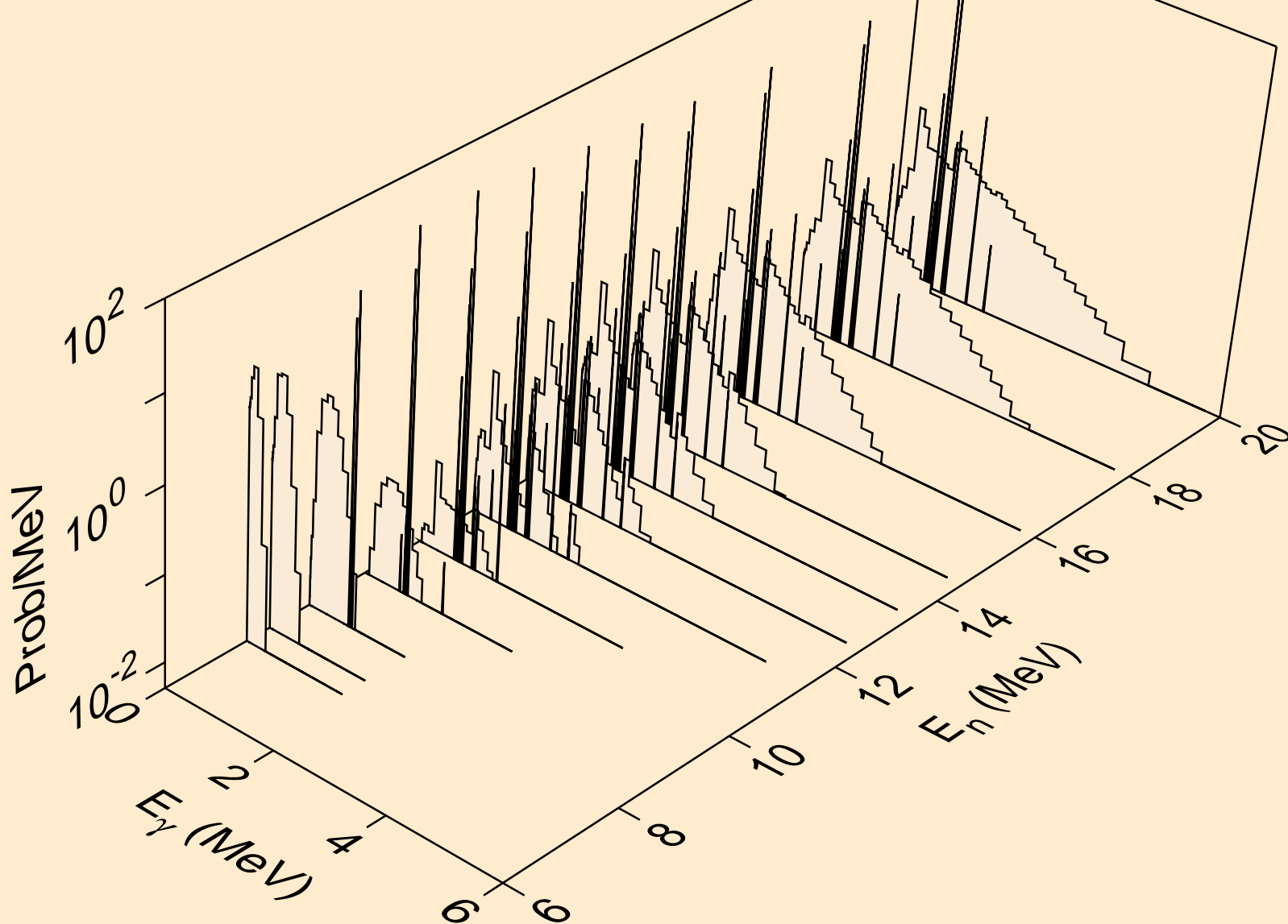

MAT=4331 ACE FILE PRODUCED AT NEA WITH NDEC
Photon emission for (n,n*)d

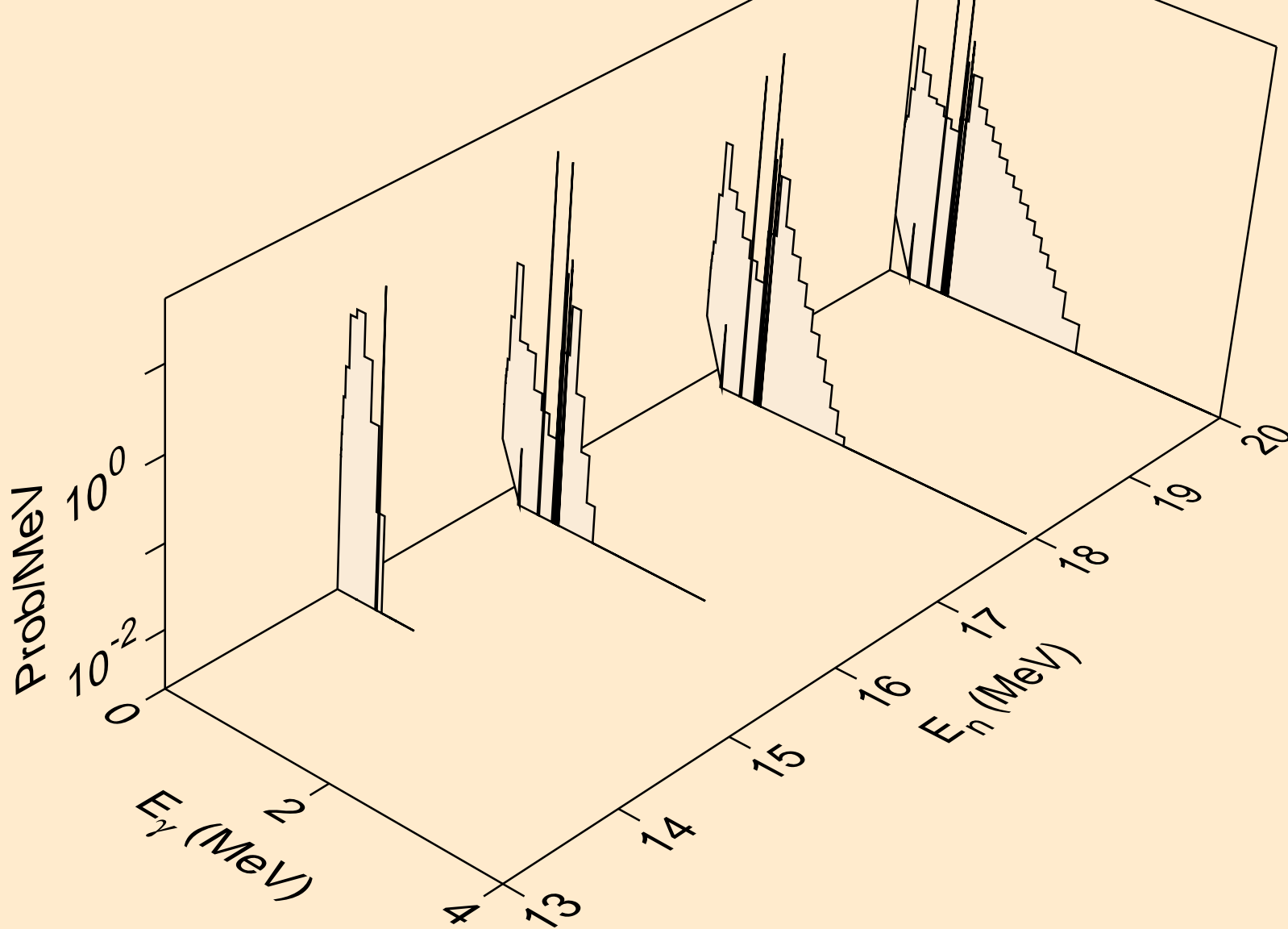

MAT=4331 ACE FILE PRODUCED AT NEA WITH NDEC
Photon emission for (n,n*)t

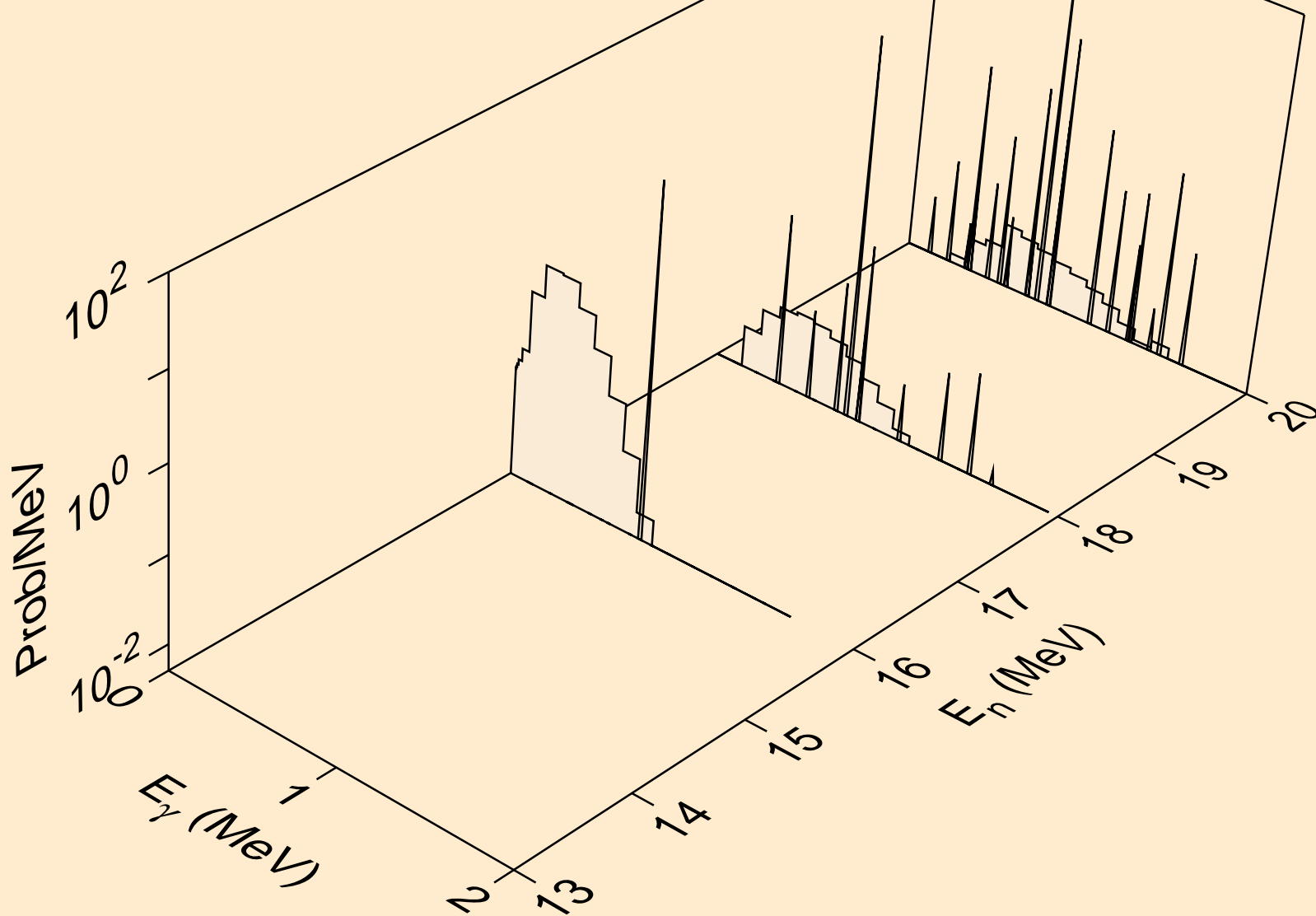

MAT=4331 ACE FILE PRODUCED AT NEA WITH NDEC
Photon emission for (n,2np)

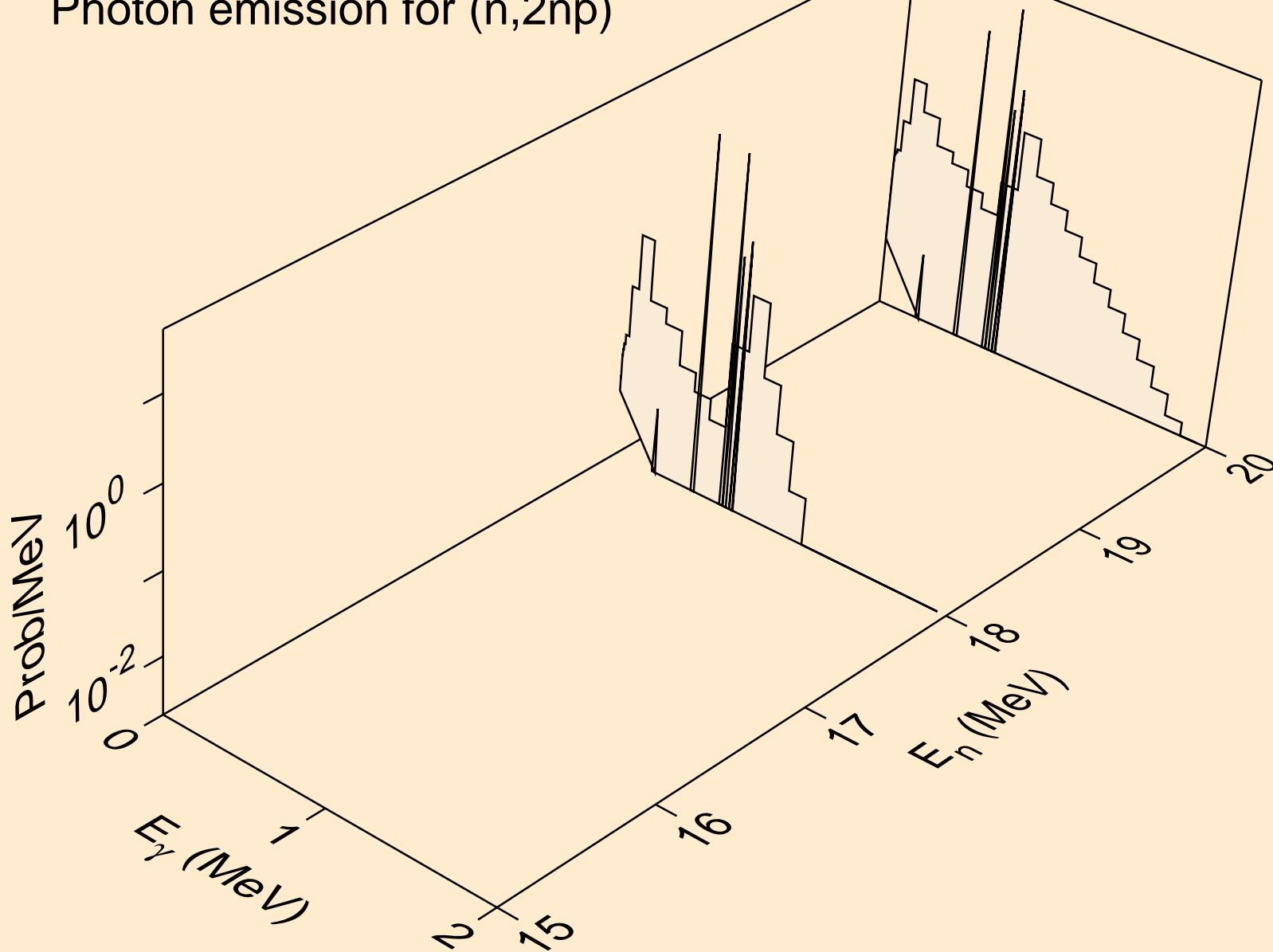

MAT=4331 ACE FILE PRODUCED AT NEA WITH NDEC
Photon emission for (n,n*1)

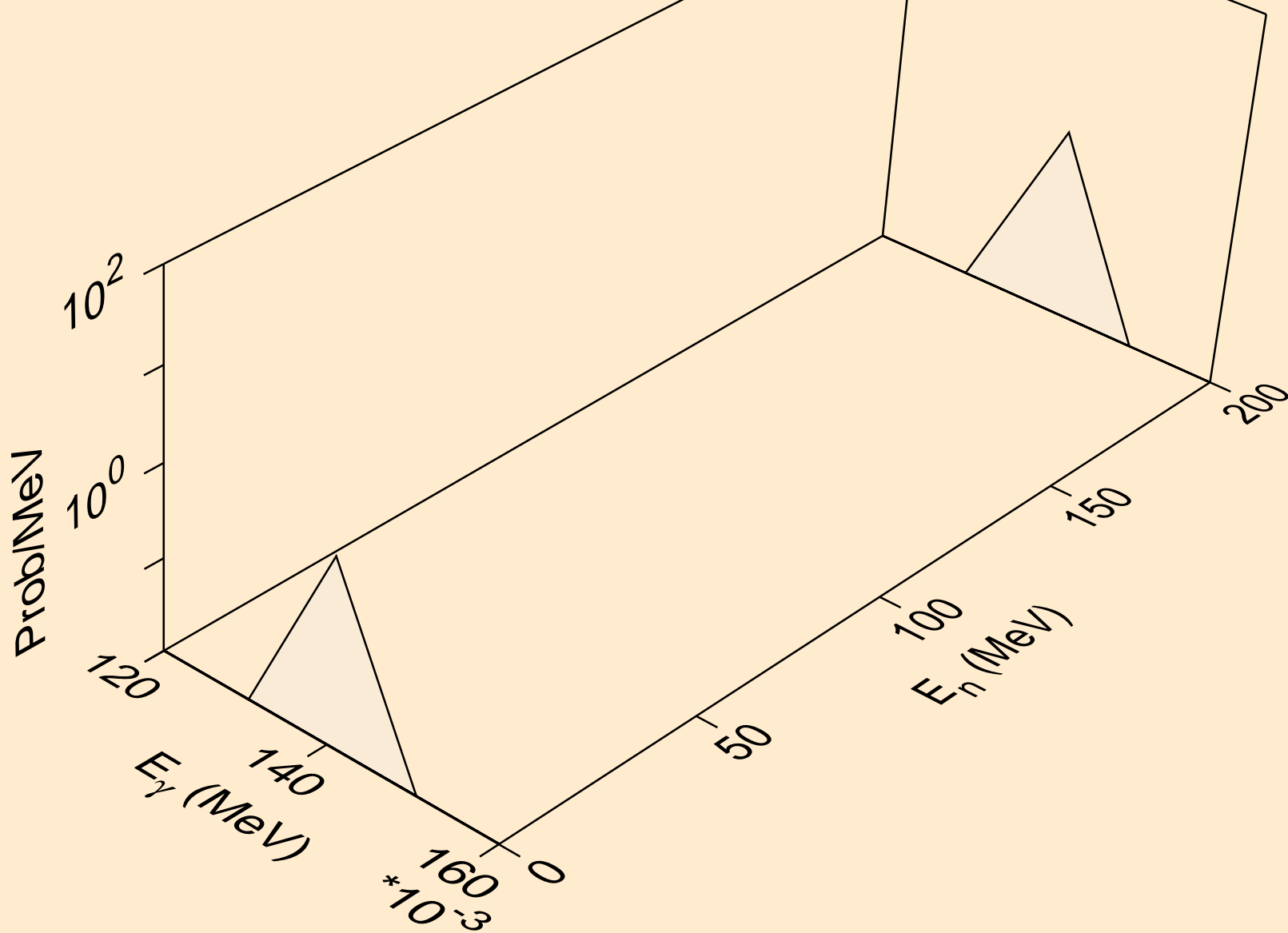

MAT=4331 ACE FILE PRODUCED AT NEA WITH NDEC
Photon emission for (n,n*3)

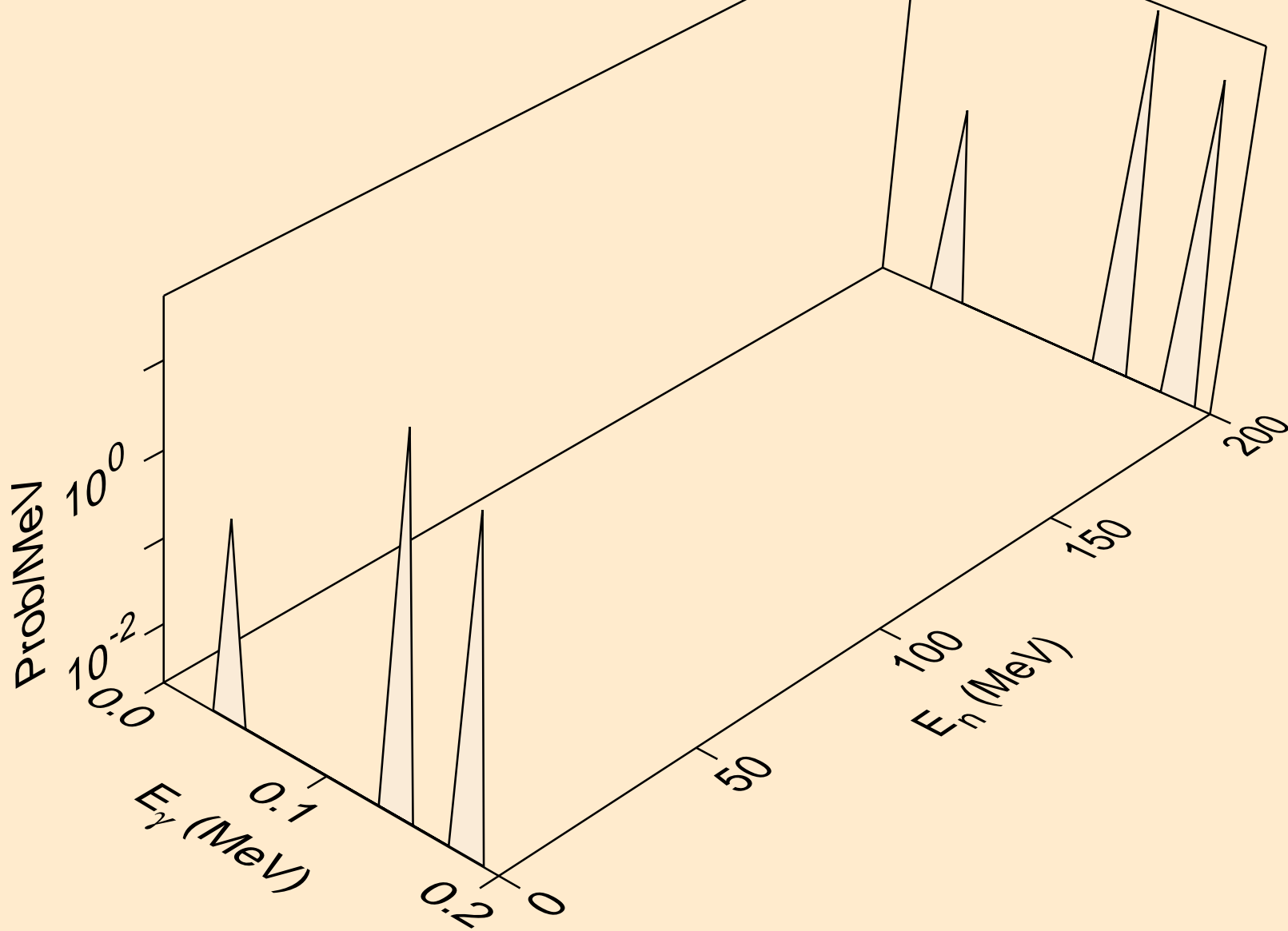

MAT=4331 ACE FILE PRODUCED AT NEA WITH NDEC
Photon emission for (n,n*4)

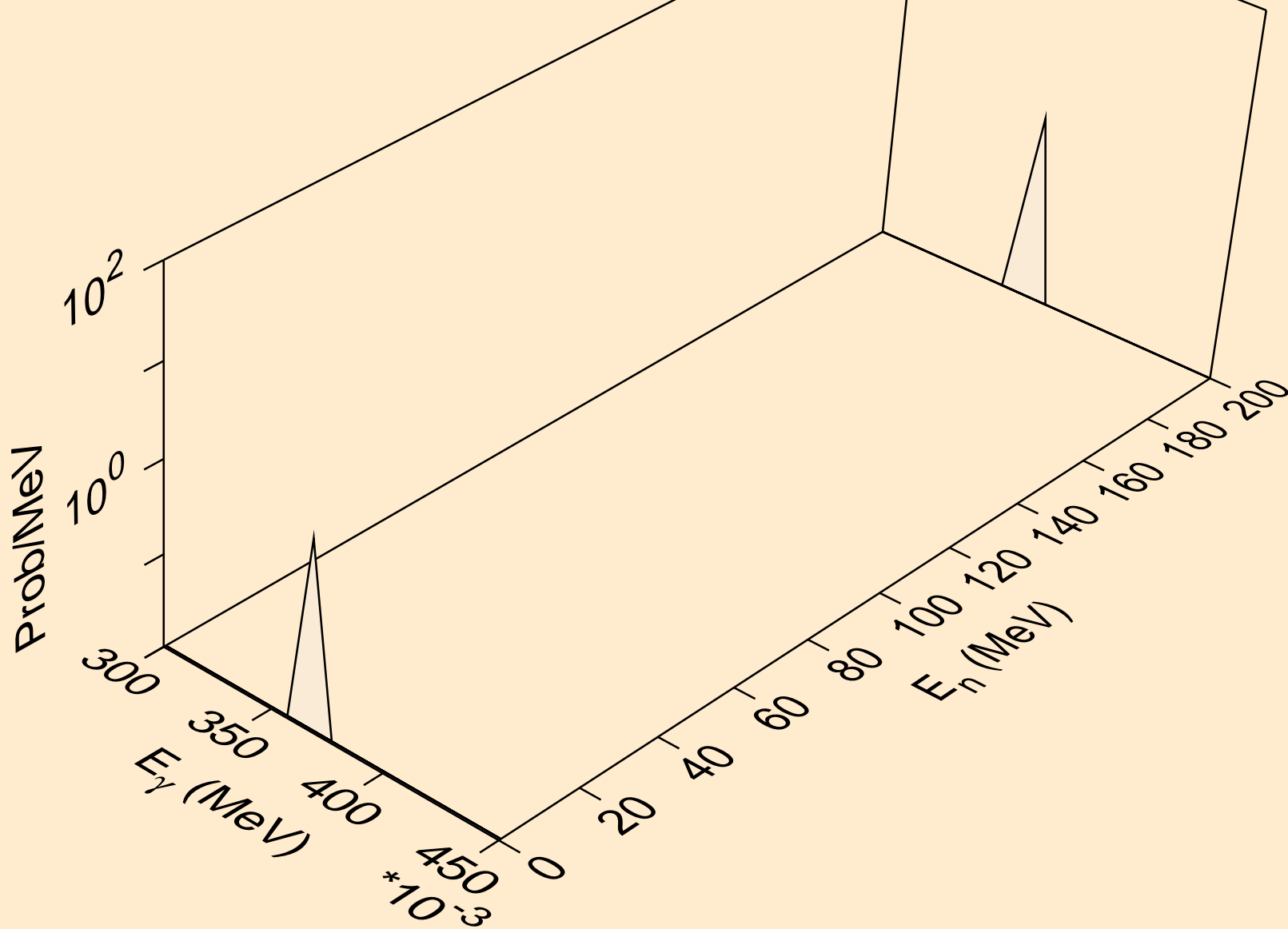

MAT=4331 ACE FILE PRODUCED AT NEA WITH NDEC
Photon emission for (n,n*5)

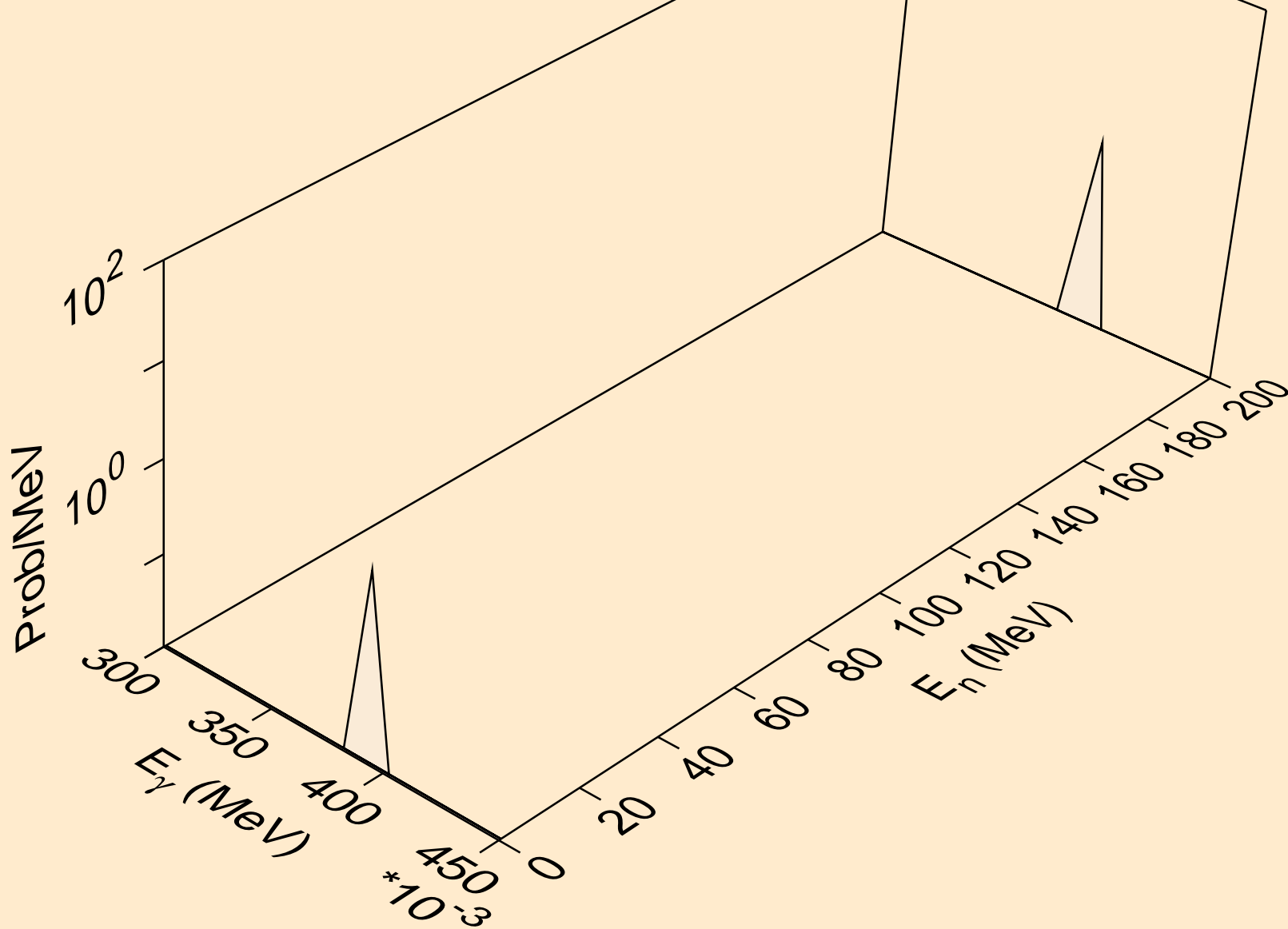

MAT=4331 ACE FILE PRODUCED AT NEA WITH NDEC
Photon emission for (n,n*6)

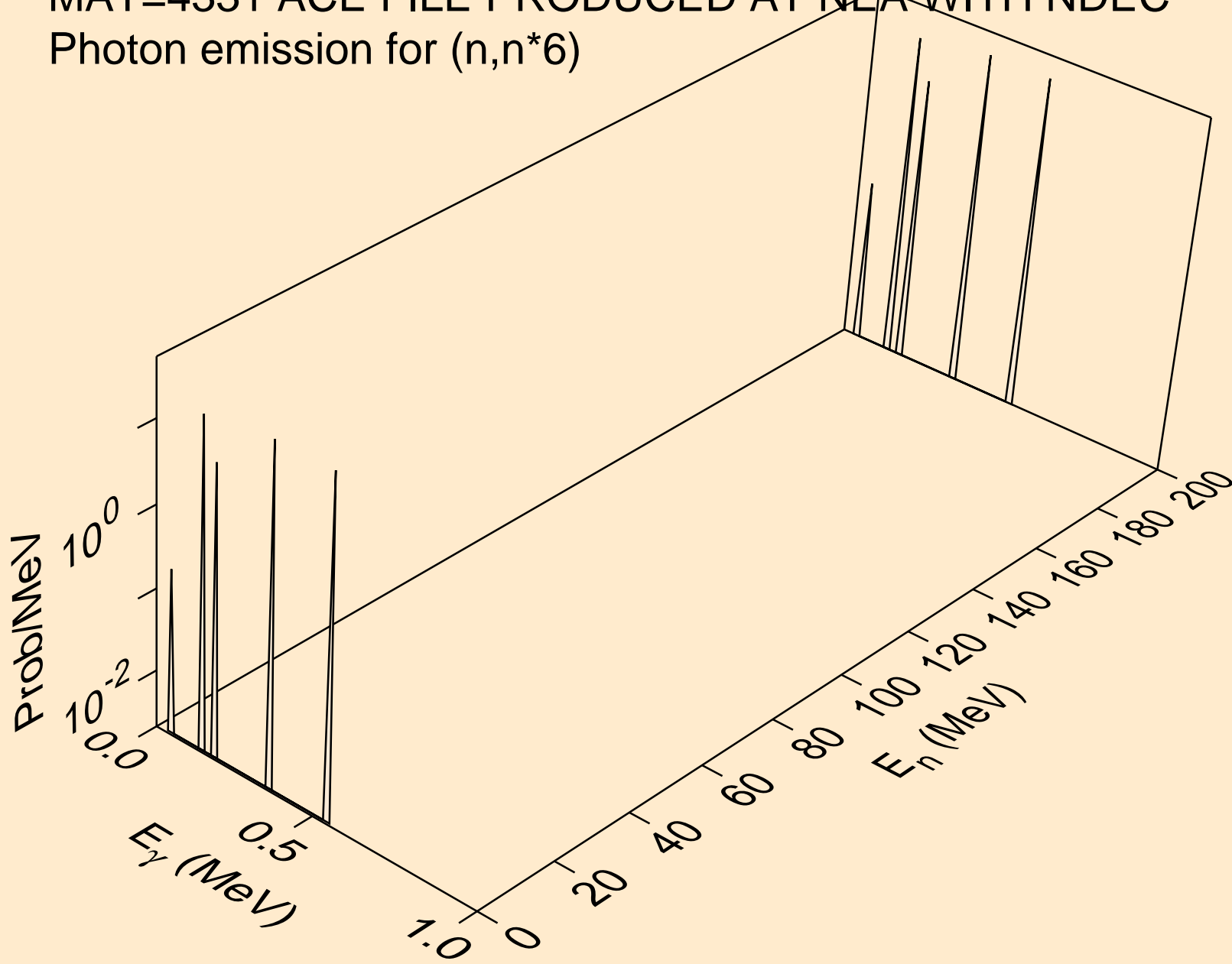

MAT=4331 ACE FILE PRODUCED AT NEA WITH NDEC
Photon emission for (n,n*7)

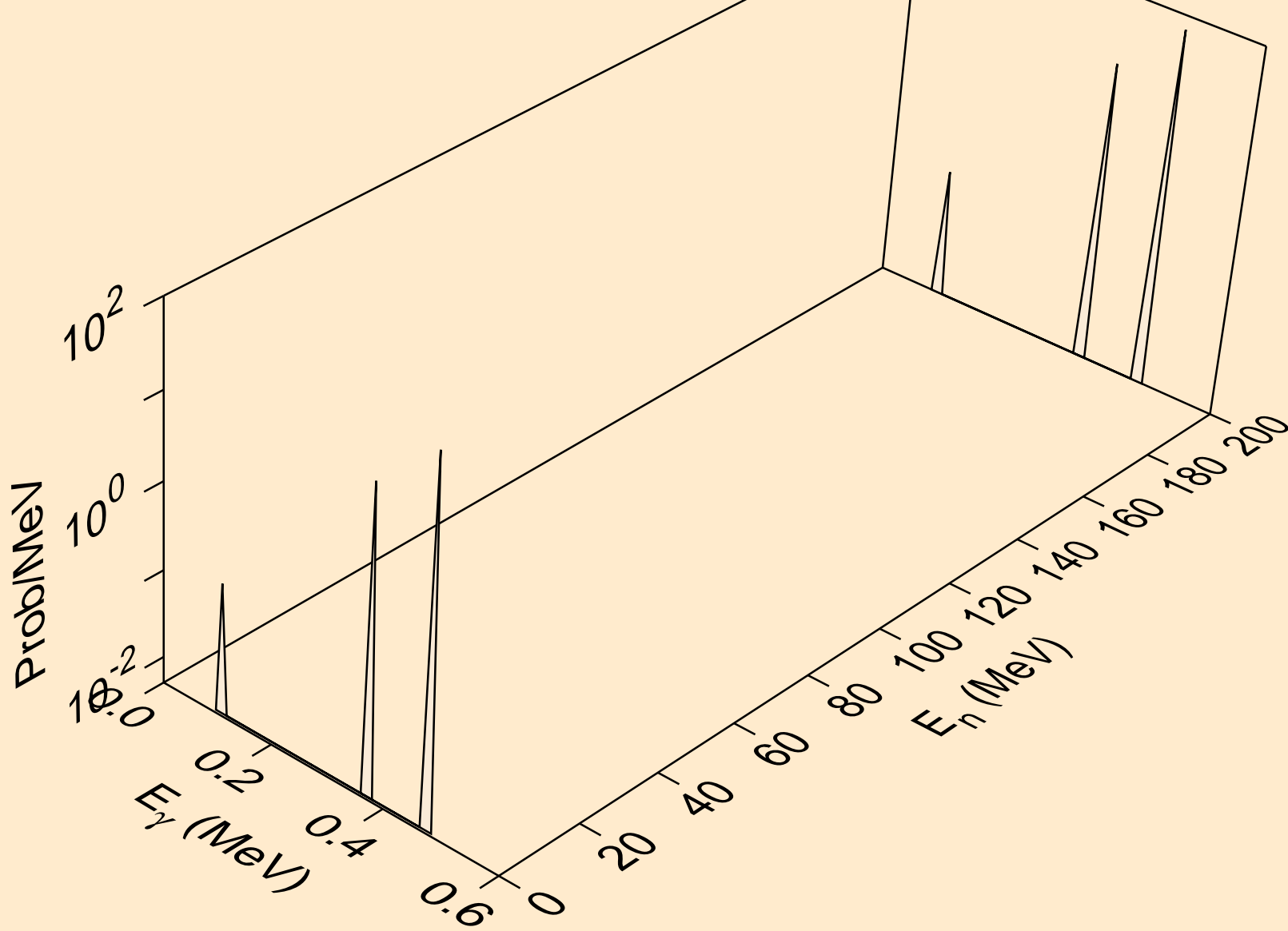

MAT=4331 ACE FILE PRODUCED AT NEA WITH NDEC
Photon emission for (n,n*8)

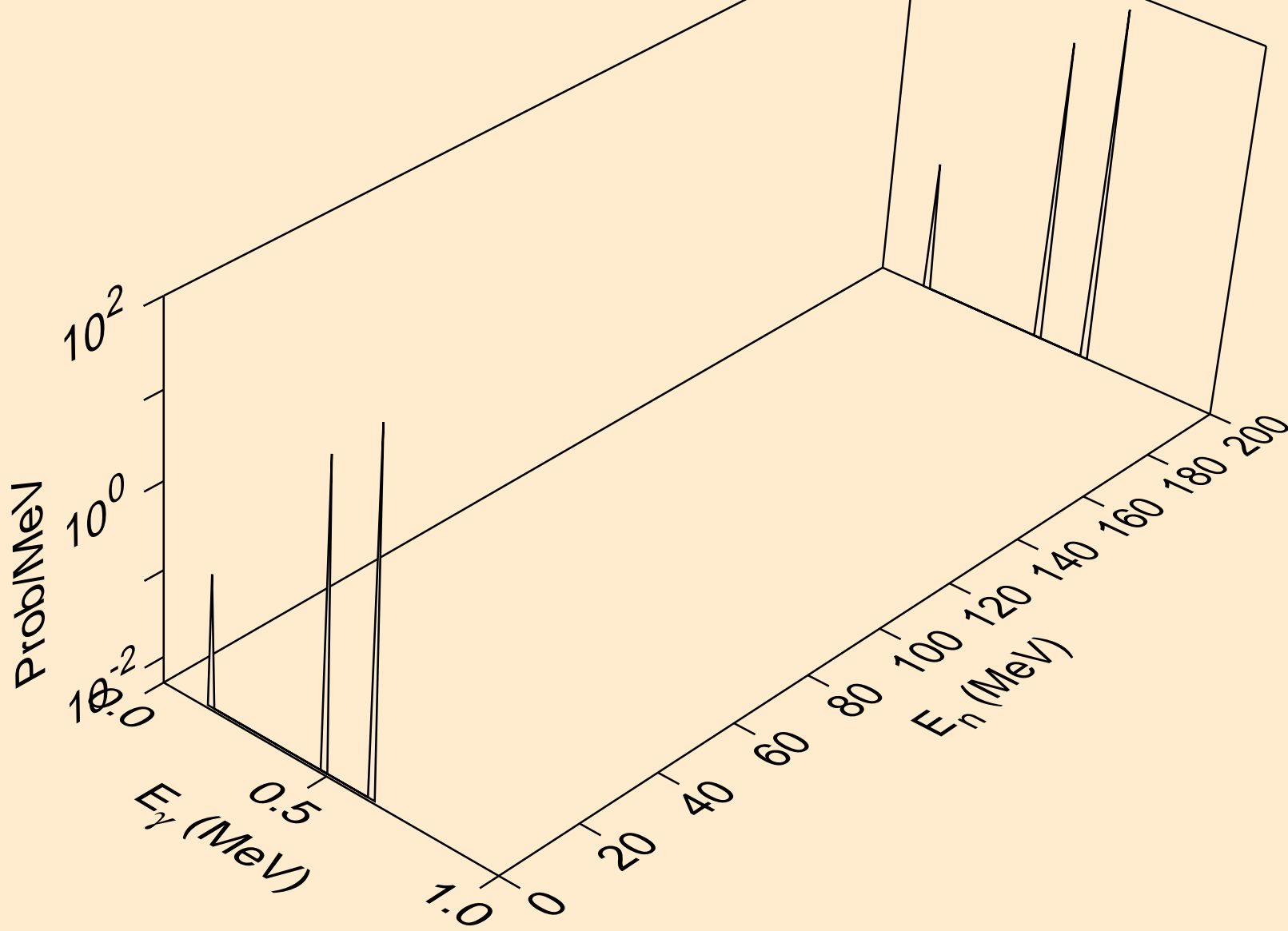

MAT=4331 ACE FILE PRODUCED AT NEA WITH NDEC
Photon emission for (n,n*9)

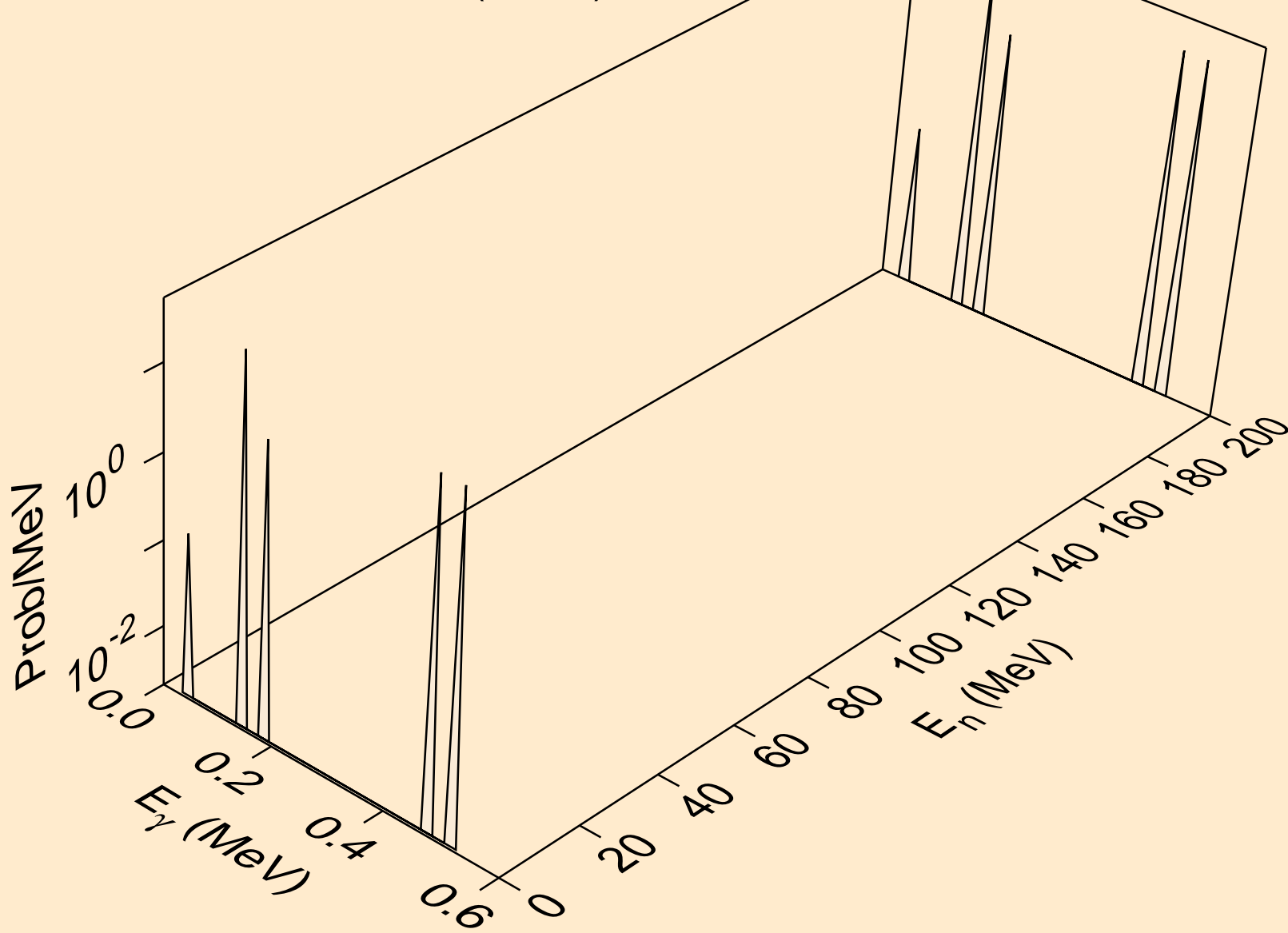

MAT=4331 ACE FILE PRODUCED AT NEA WITH NDEC
Photon emission for (n,n*10)

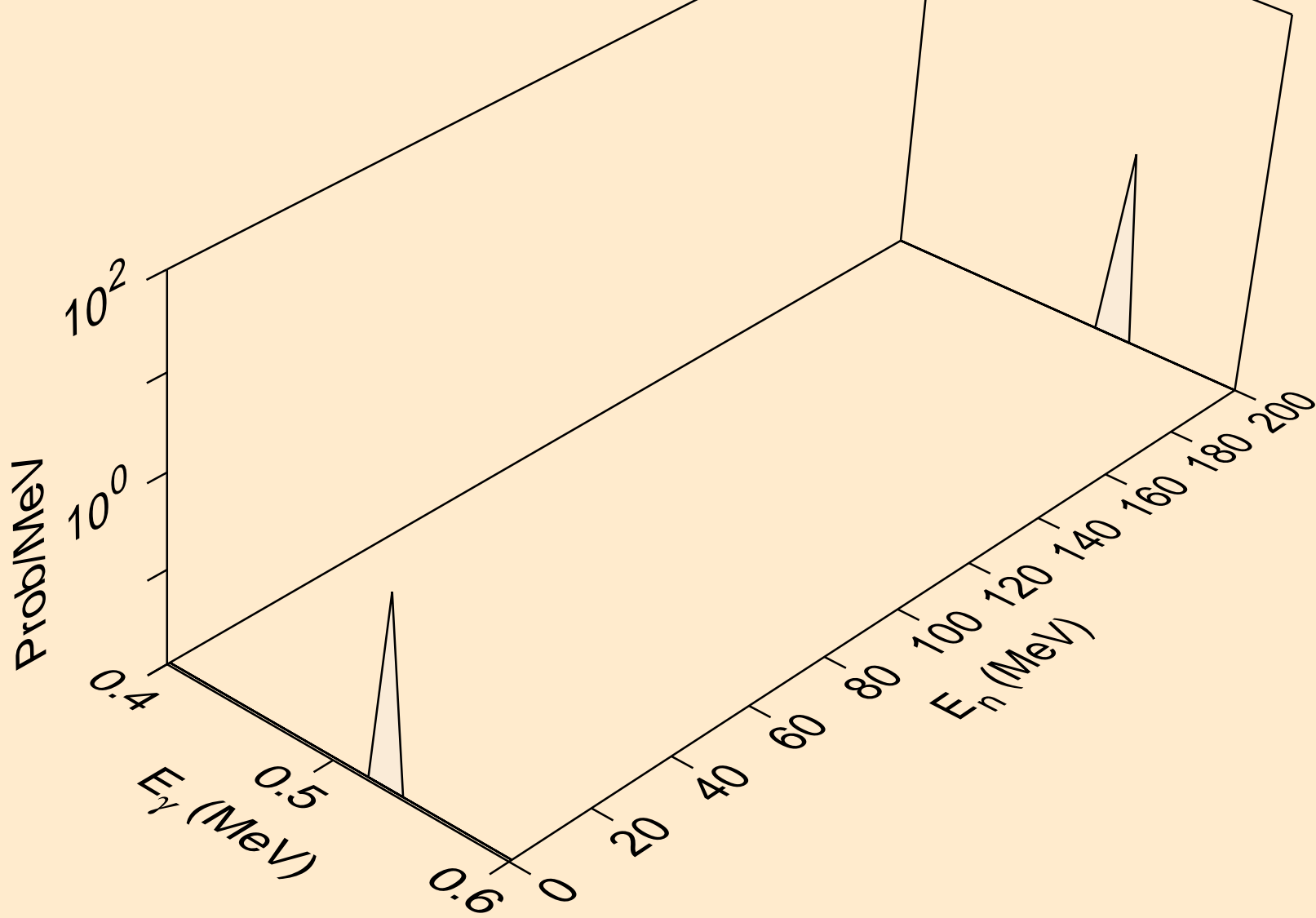

MAT=4331 ACE FILE PRODUCED AT NEA WITH NDEC
Photon emission for (n,n*11)

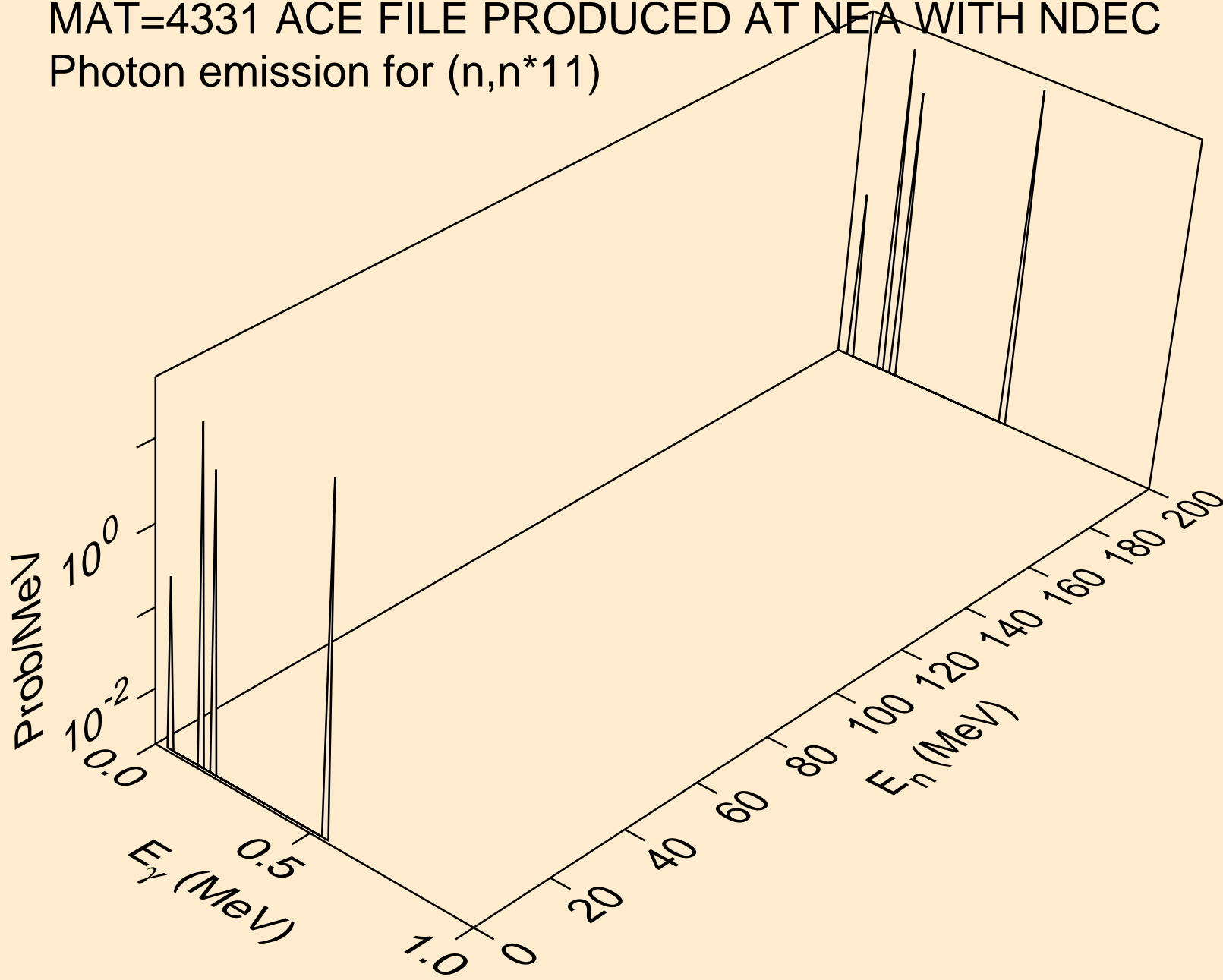

MAT=4331 ACE FILE PRODUCED AT NEA WITH NDEC
Photon emission for (n,n*12)

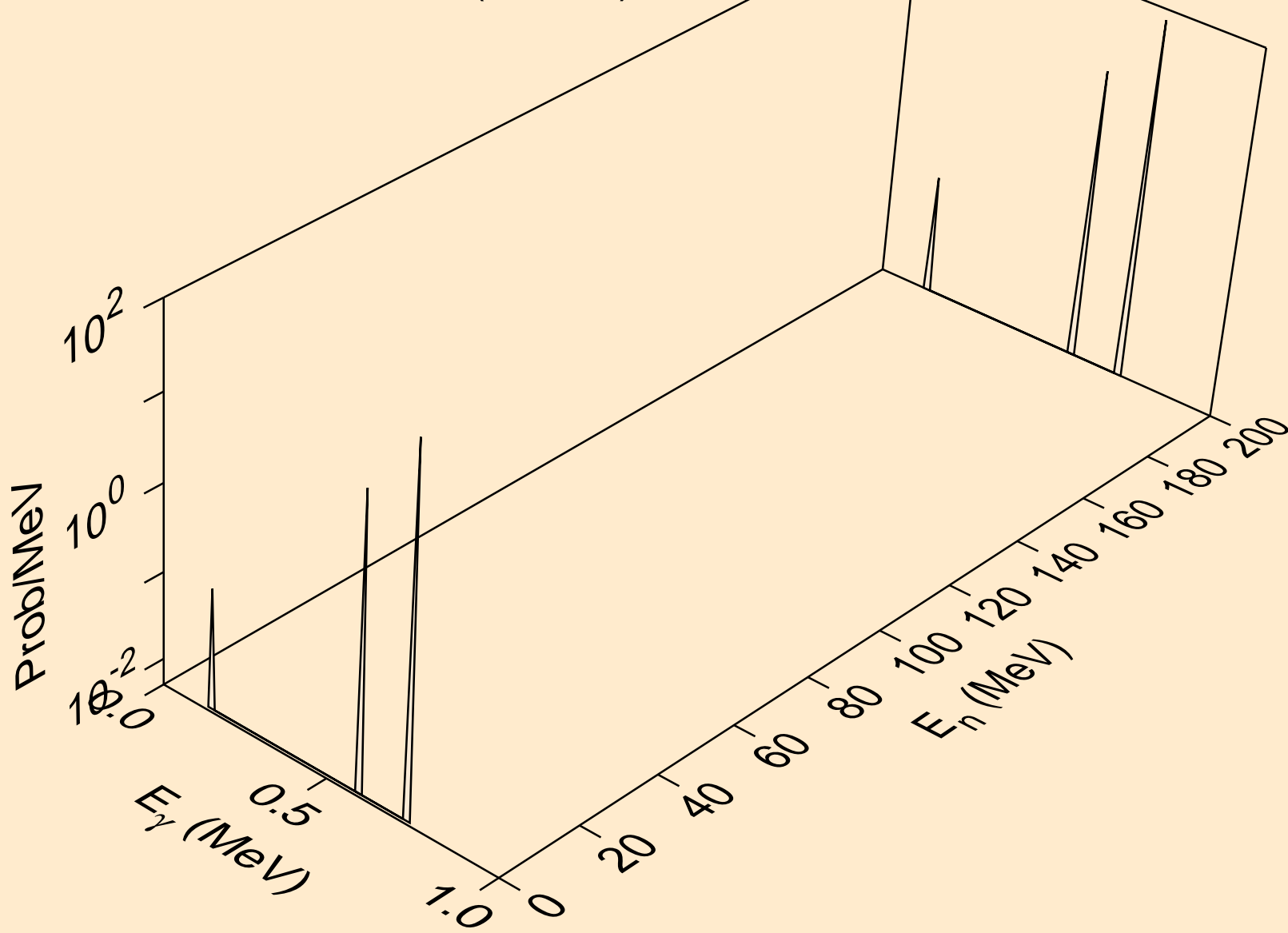

MAT=4331 ACE FILE PRODUCED AT NEA WITH NDEC
Photon emission for (n,n*13)

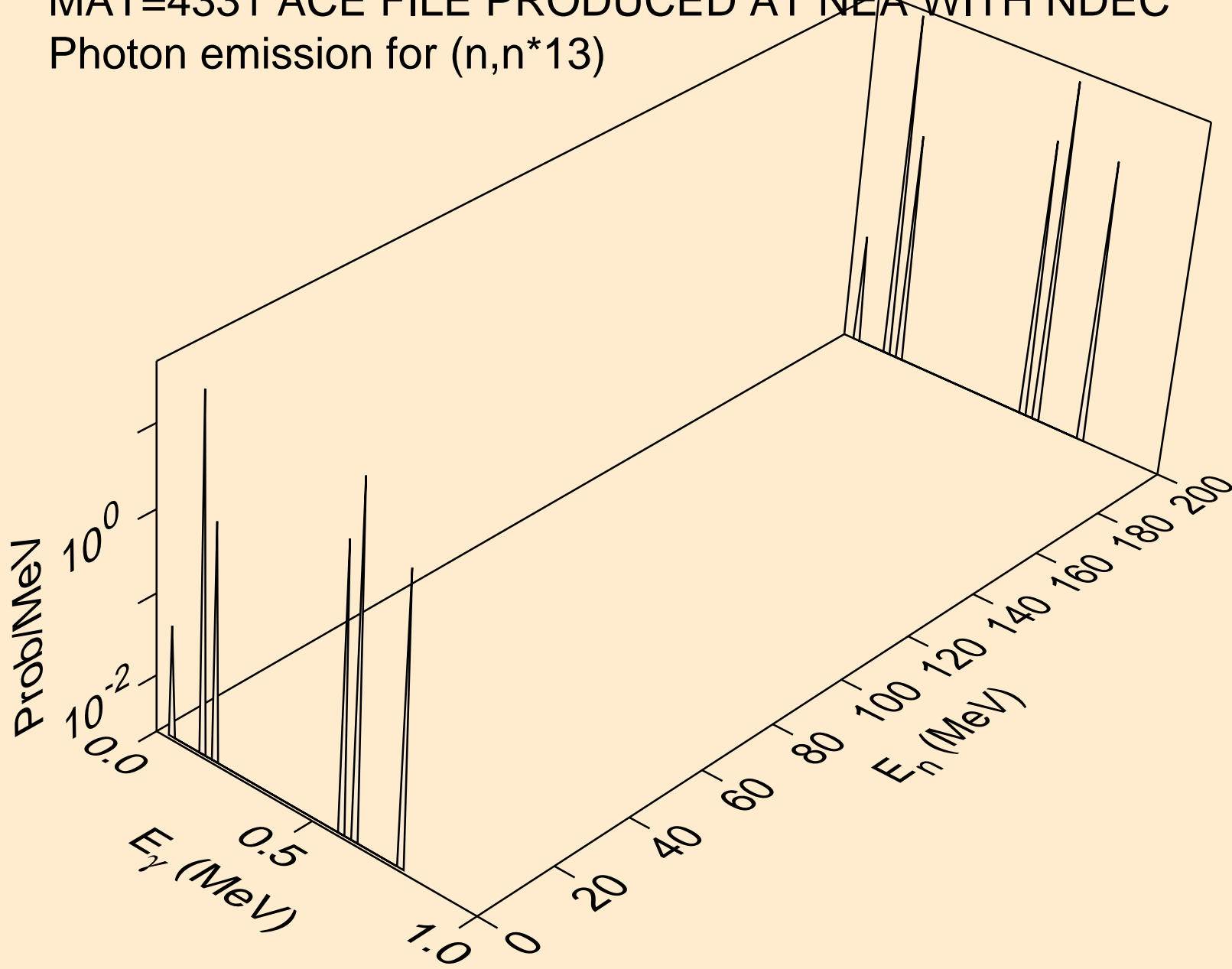

MAT=4331 ACE FILE PRODUCED AT NEA WITH NDEC
Photon emission for (n,n*14)

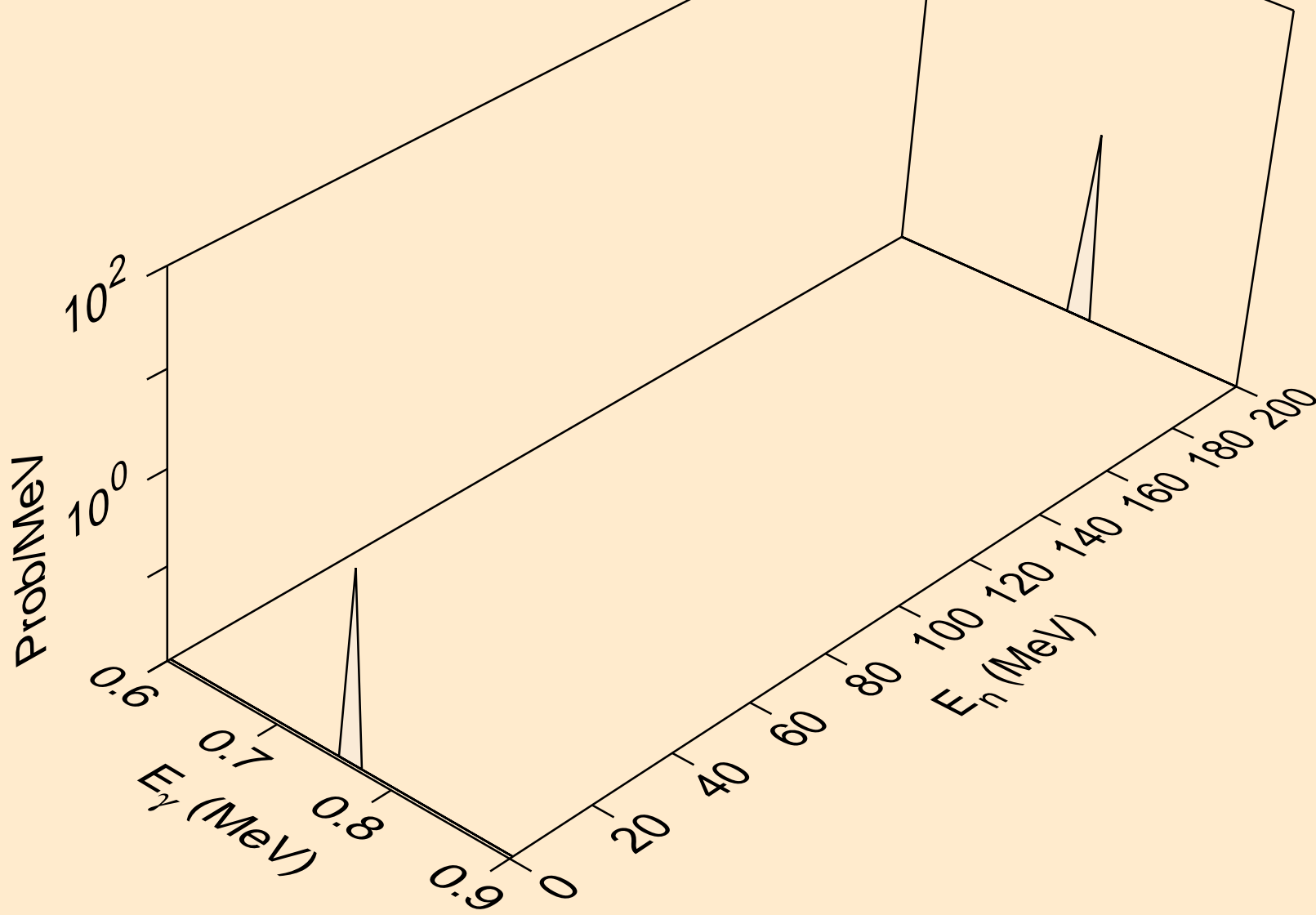

MAT=4331 ACE FILE PRODUCED AT NEA WITH NDEC
Photon emission for (n,n*15)

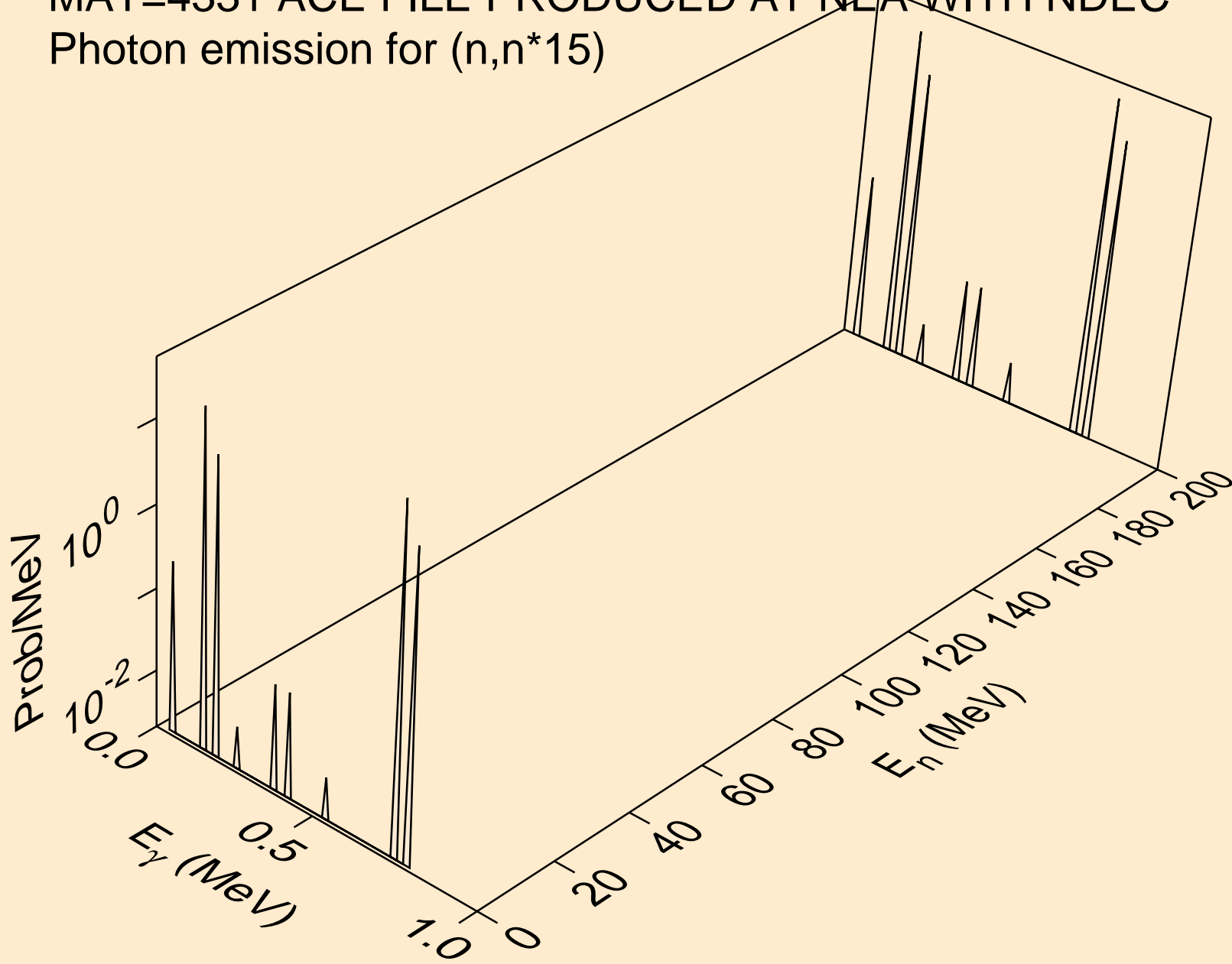

MAT=4331 ACE FILE PRODUCED AT NEA WITH NDEC
Photon emission for (n,n*16)

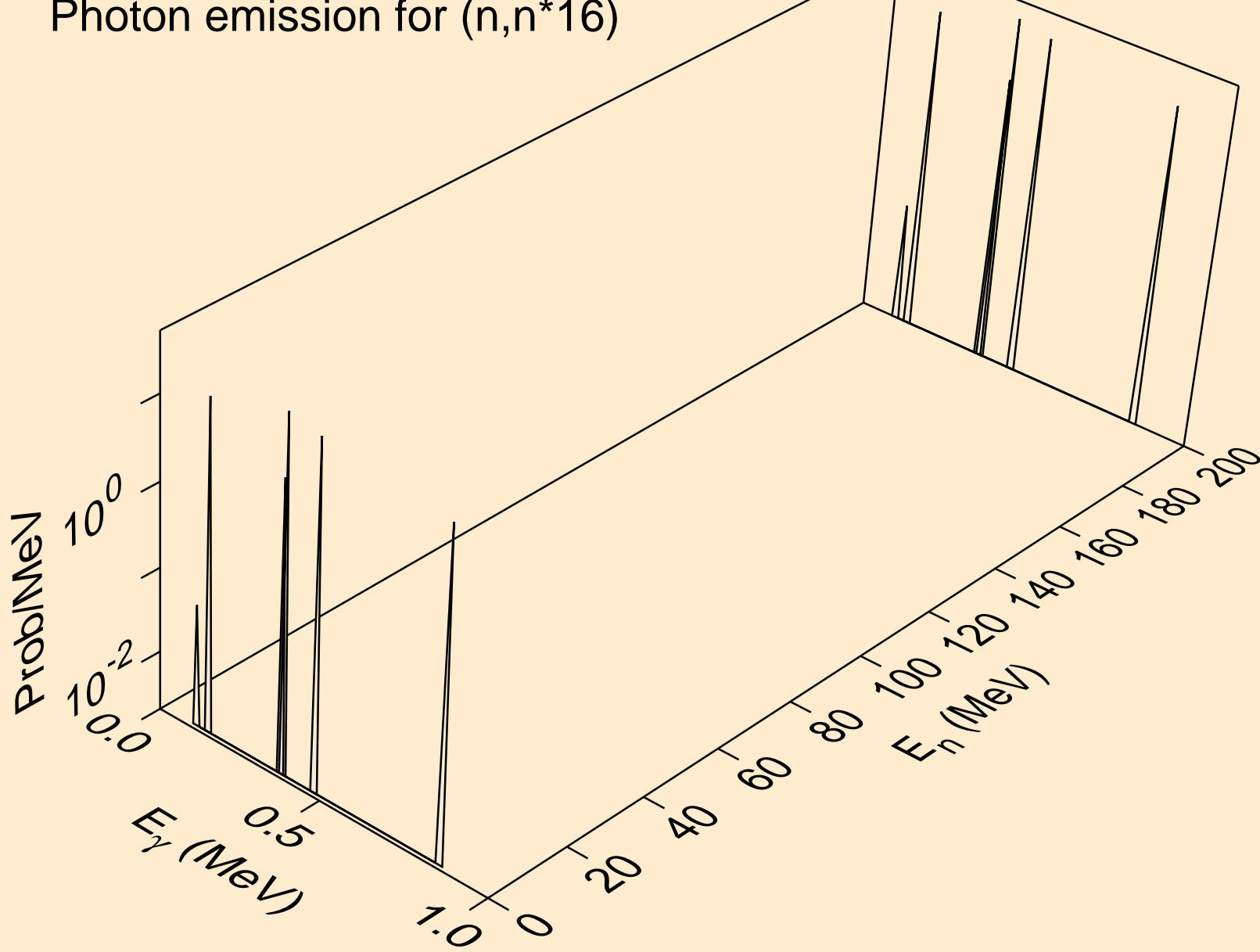

MAT=4331 ACE FILE PRODUCED AT NEA WITH NDEC
Photon emission for (n,n*17)

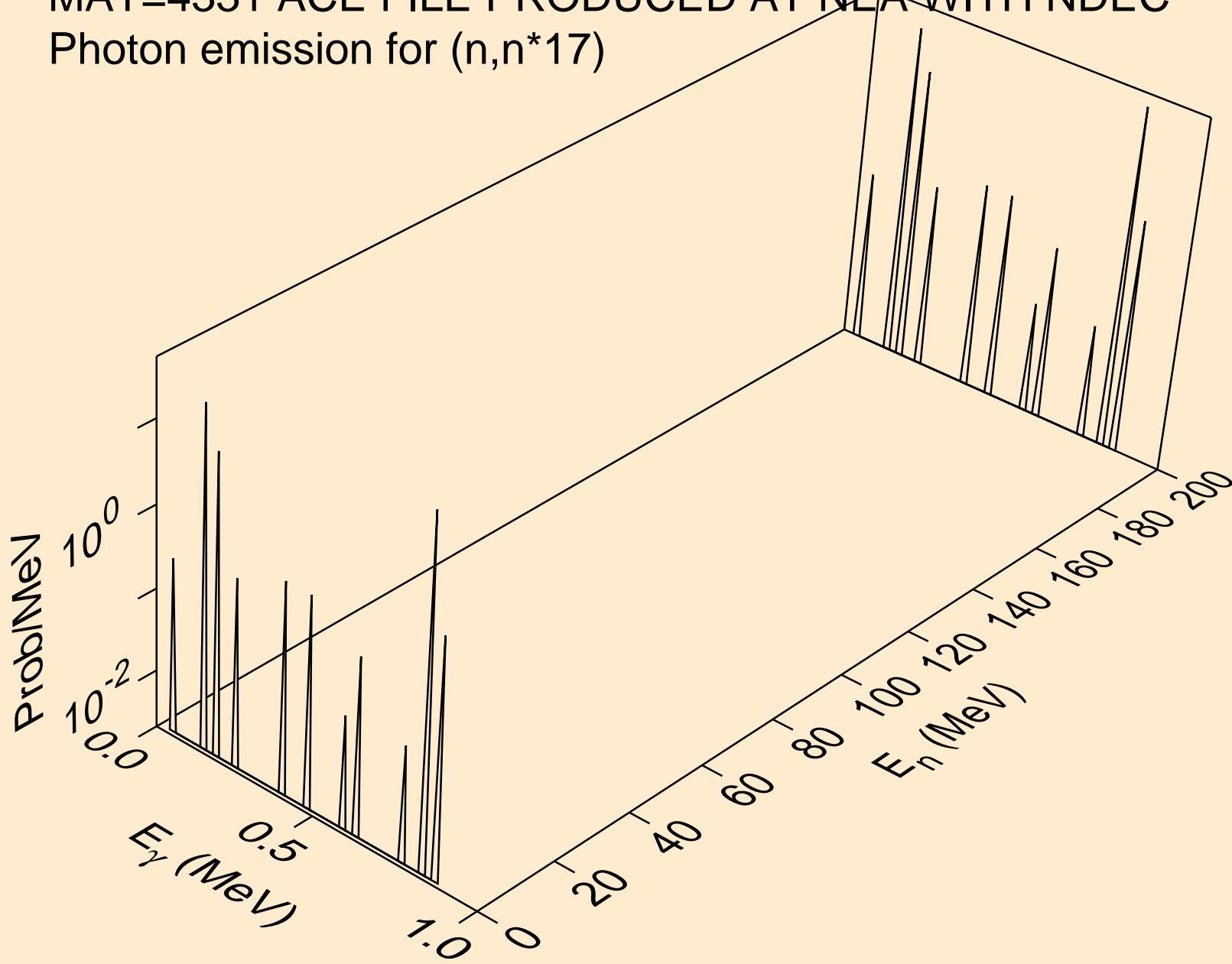

MAT=4331 ACE FILE PRODUCED AT NEA WITH NDEC
Photon emission for (n,n*18)

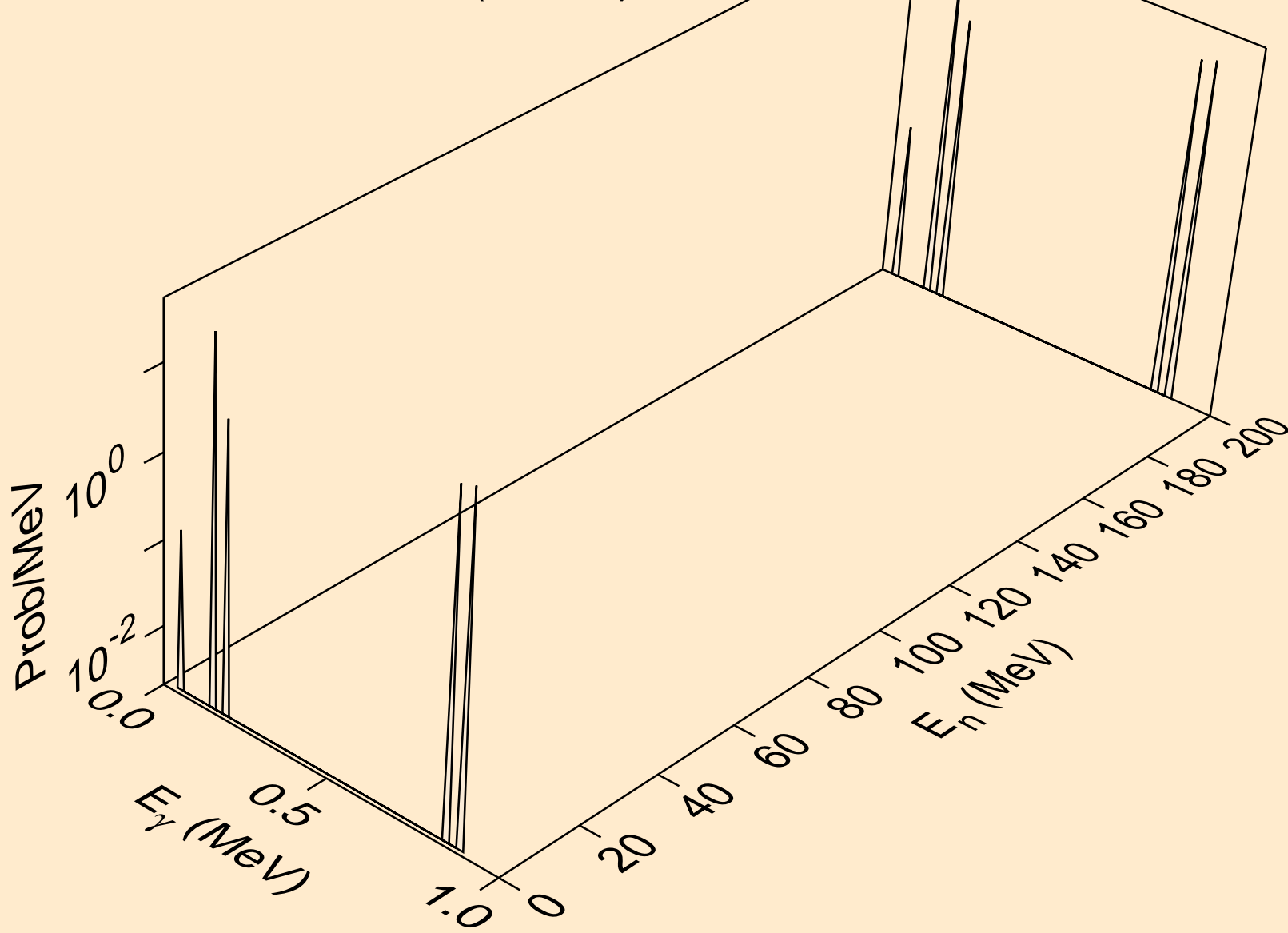

MAT=4331 ACE FILE PRODUCED AT NEA WITH NDEC
Photon emission for (n,n*19)

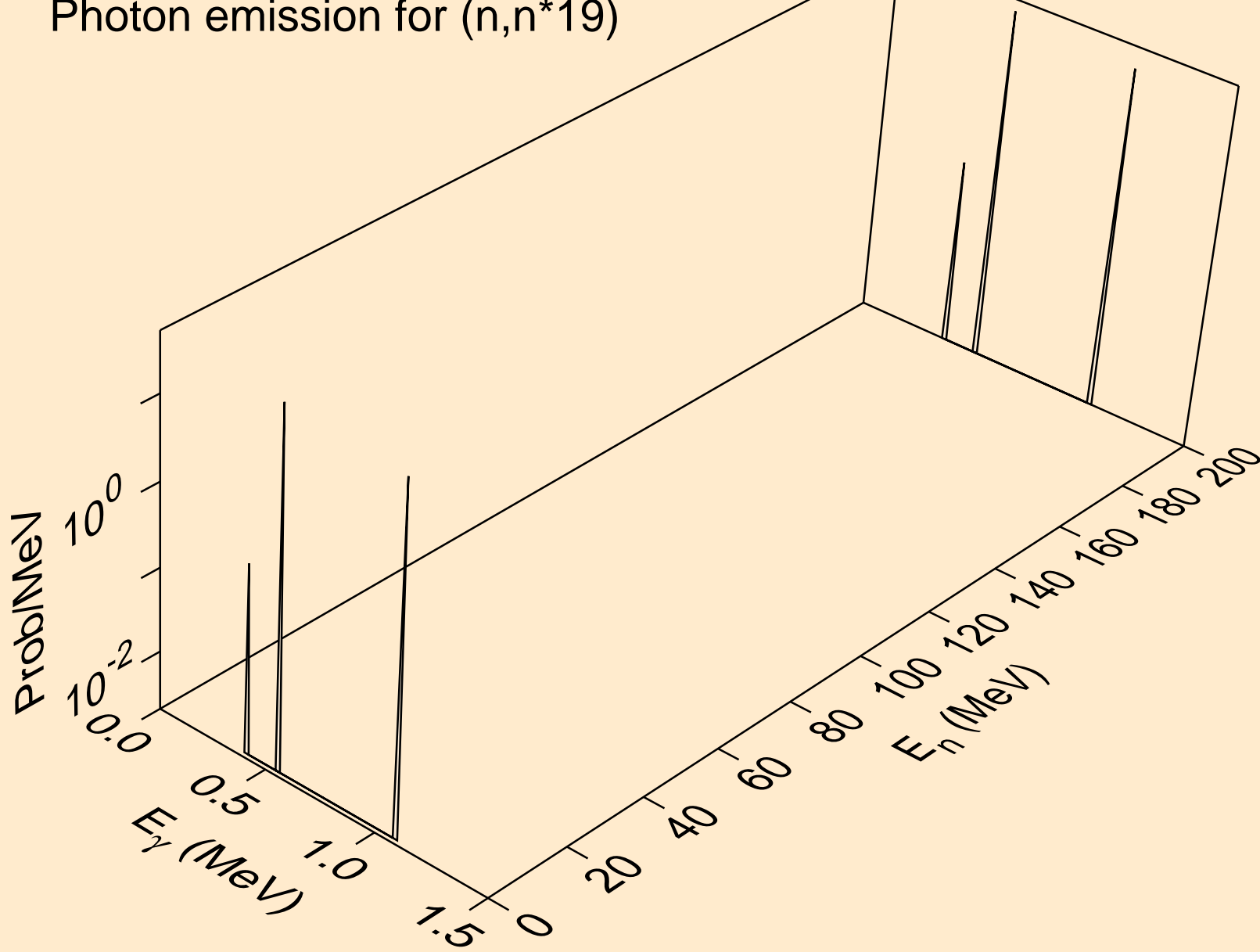

MAT=4331 ACE FILE PRODUCED AT NEA WITH NDEC
Photon emission for (n,n*20)

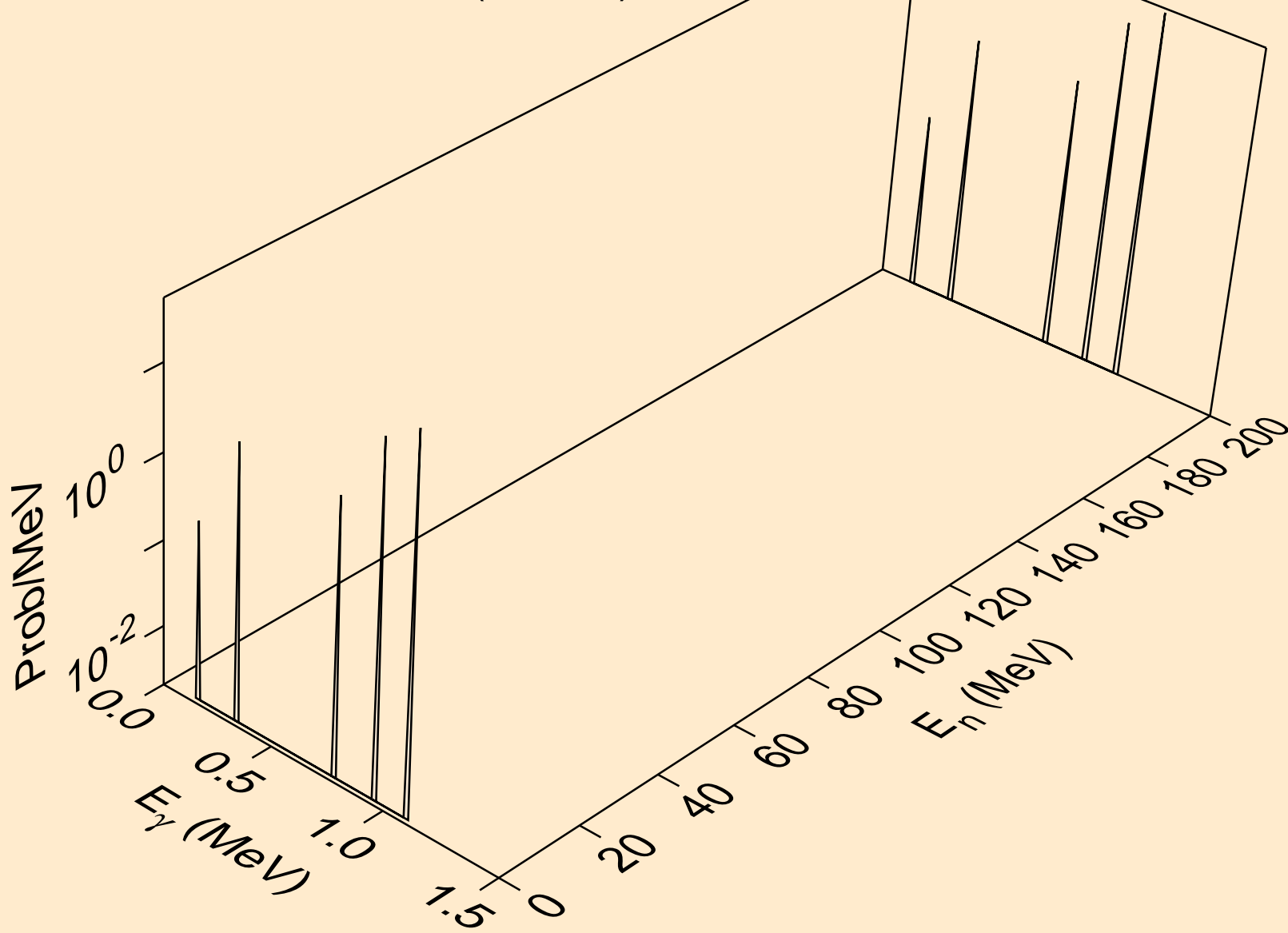

MAT=4331 ACE FILE PRODUCED AT NEA WITH NDEC
Photon emission for (n,n*c)

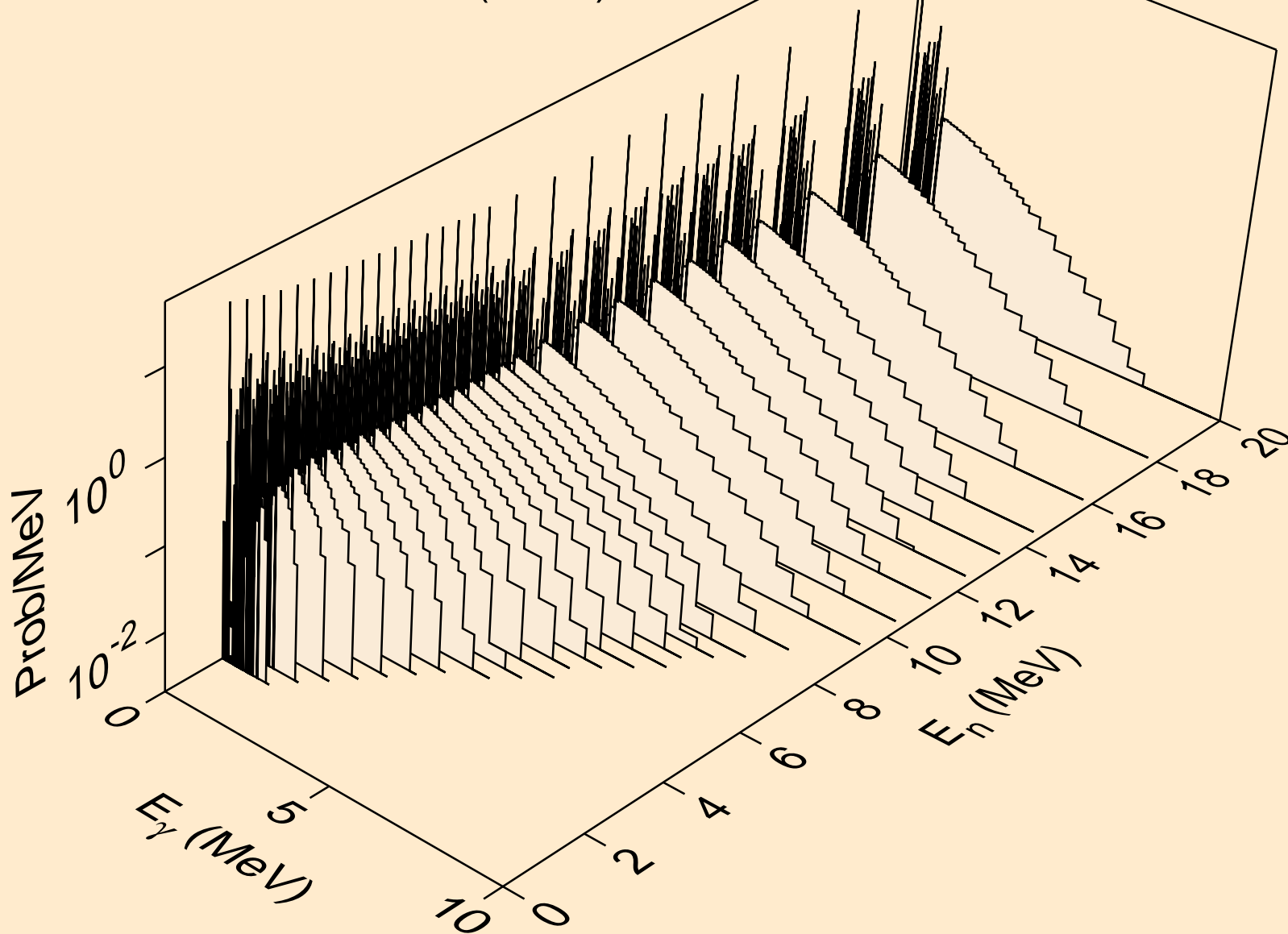

MAT=4331 ACE FILE PRODUCED AT NEA WITH NDEC
Photon emission for (n,gma)

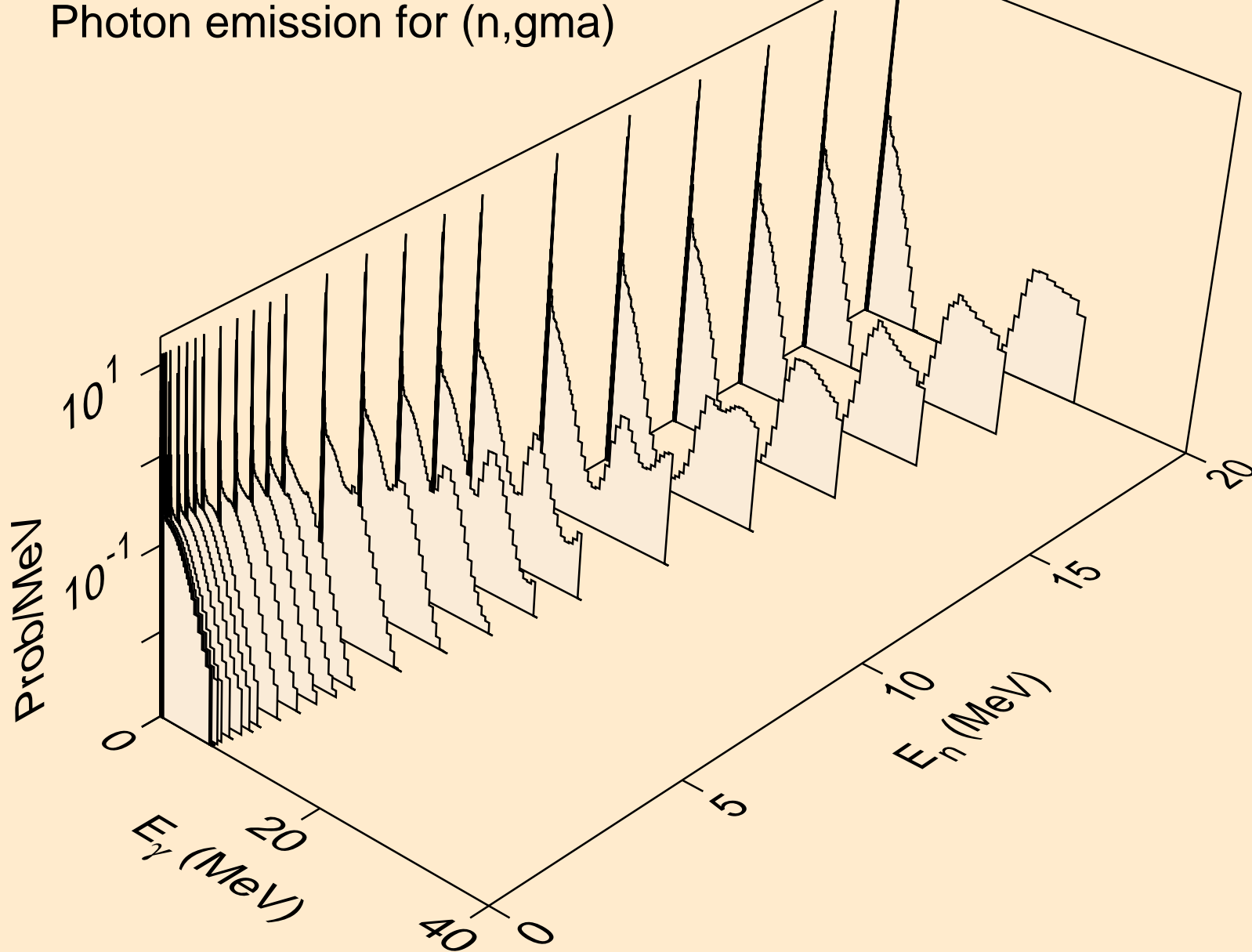

MAT=4331 ACE FILE PRODUCED AT NEA WITH NDEC
Photon emission for (n,2a)

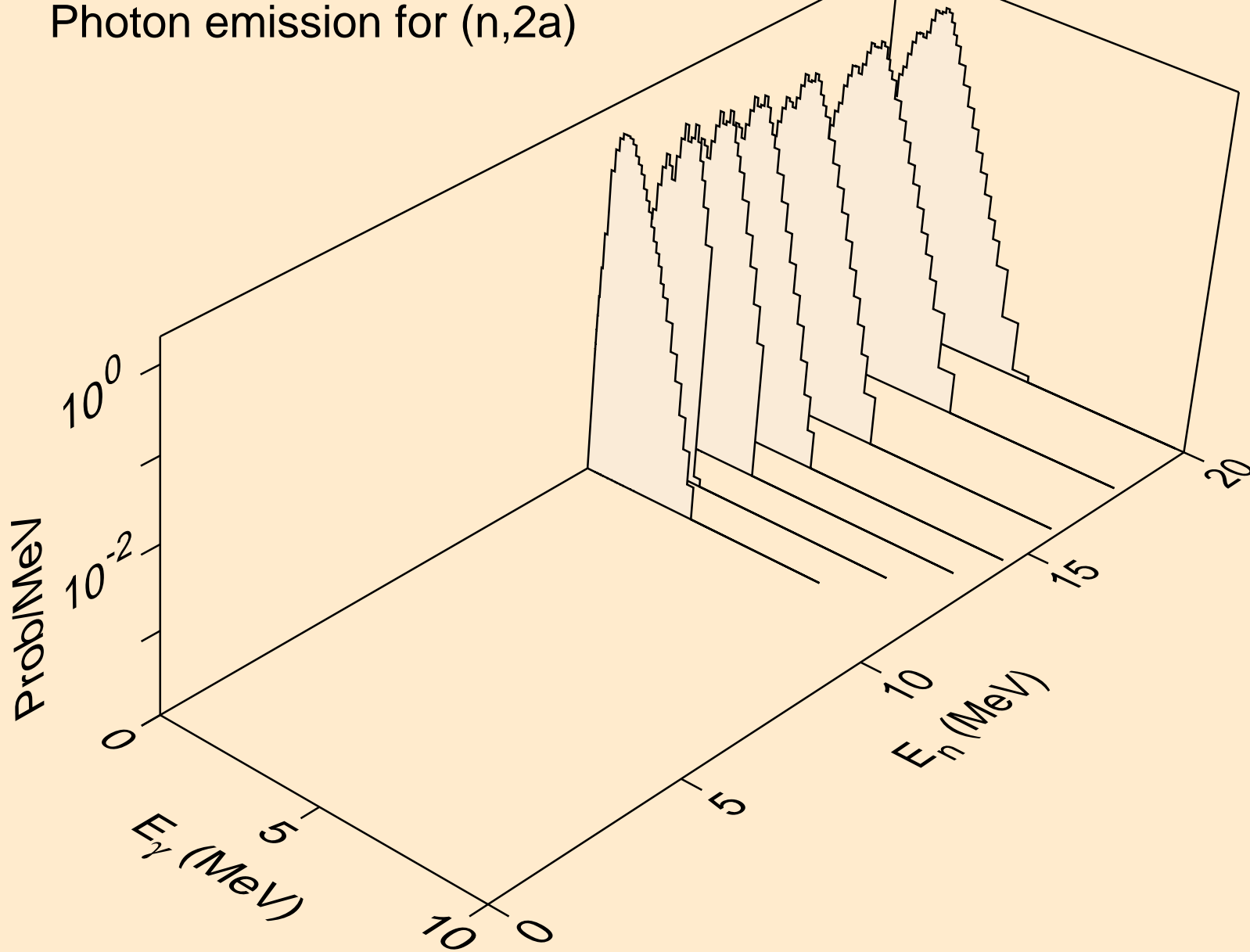

MAT=4331 ACE FILE PRODUCED AT NEA WITH NDEC
Photon emission for (n,2p)

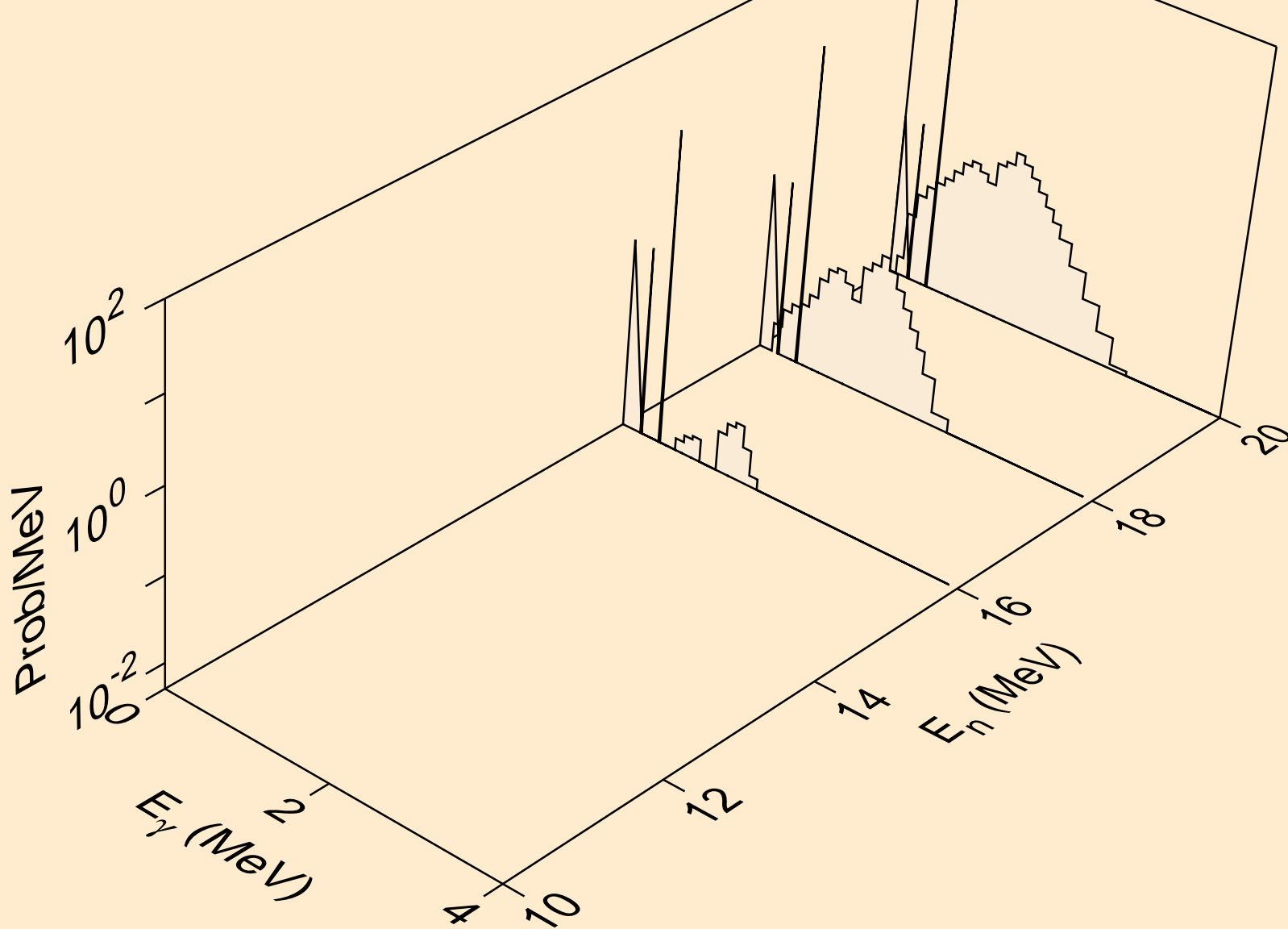

MAT=4331 ACE FILE PRODUCED AT NEA WITH NDEC
Photon emission for (n,pa)

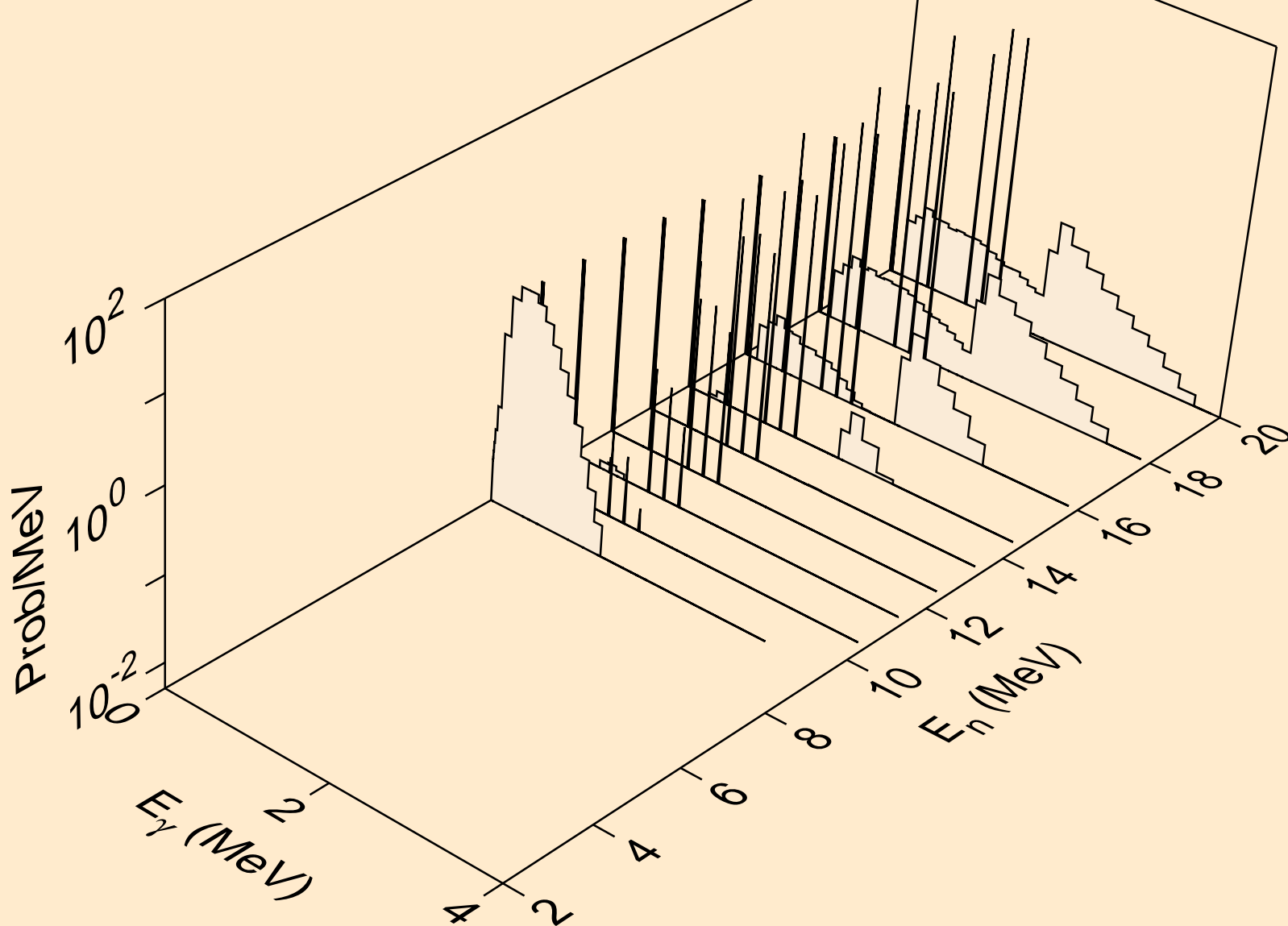

MAT=4331 ACE FILE PRODUCED AT NEA WITH NDEC
Photon emission for (n,p*1)

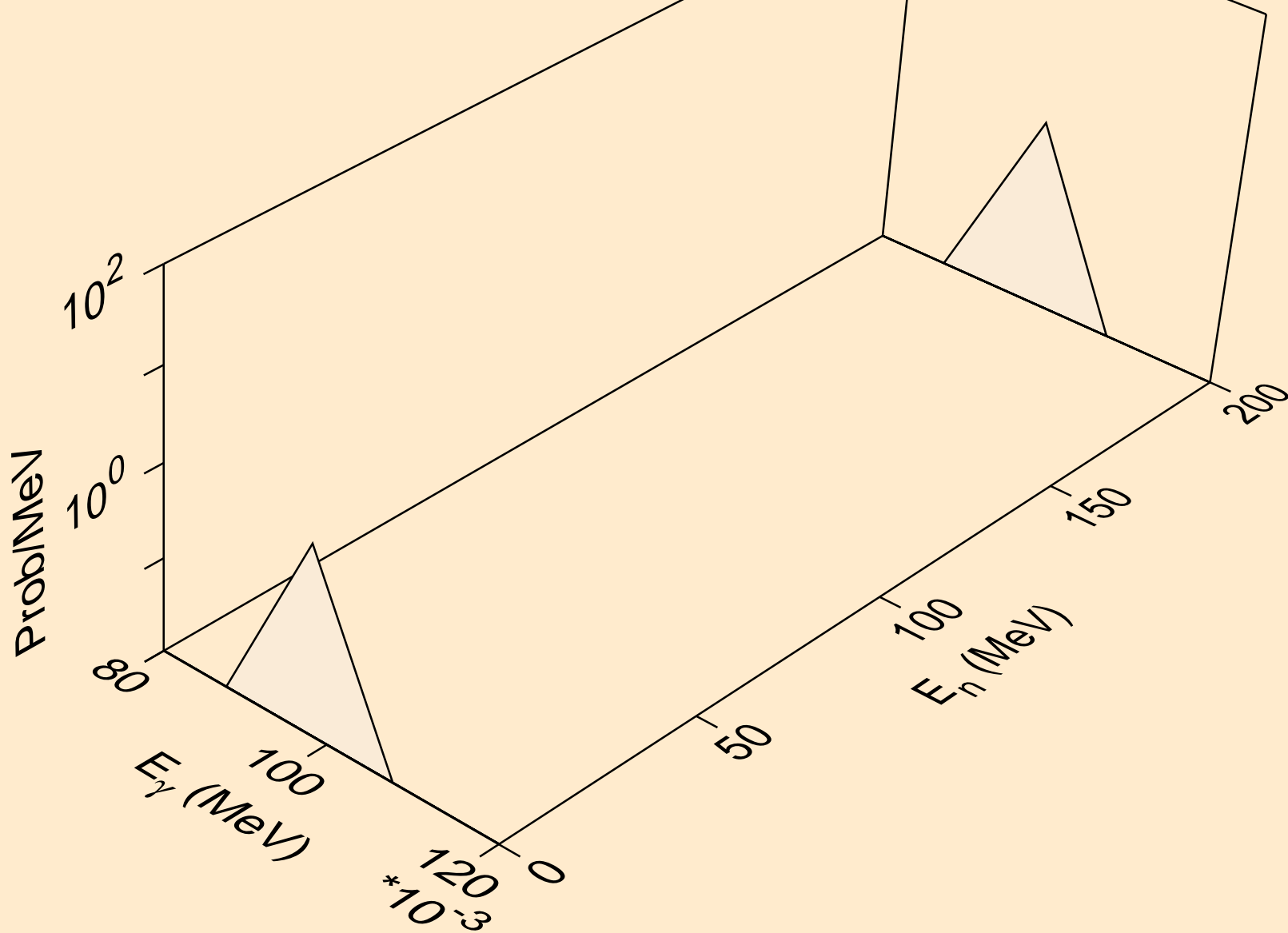

MAT=4331 ACE FILE PRODUCED AT NEA WITH NDEC
Photon emission for (n,p*2)

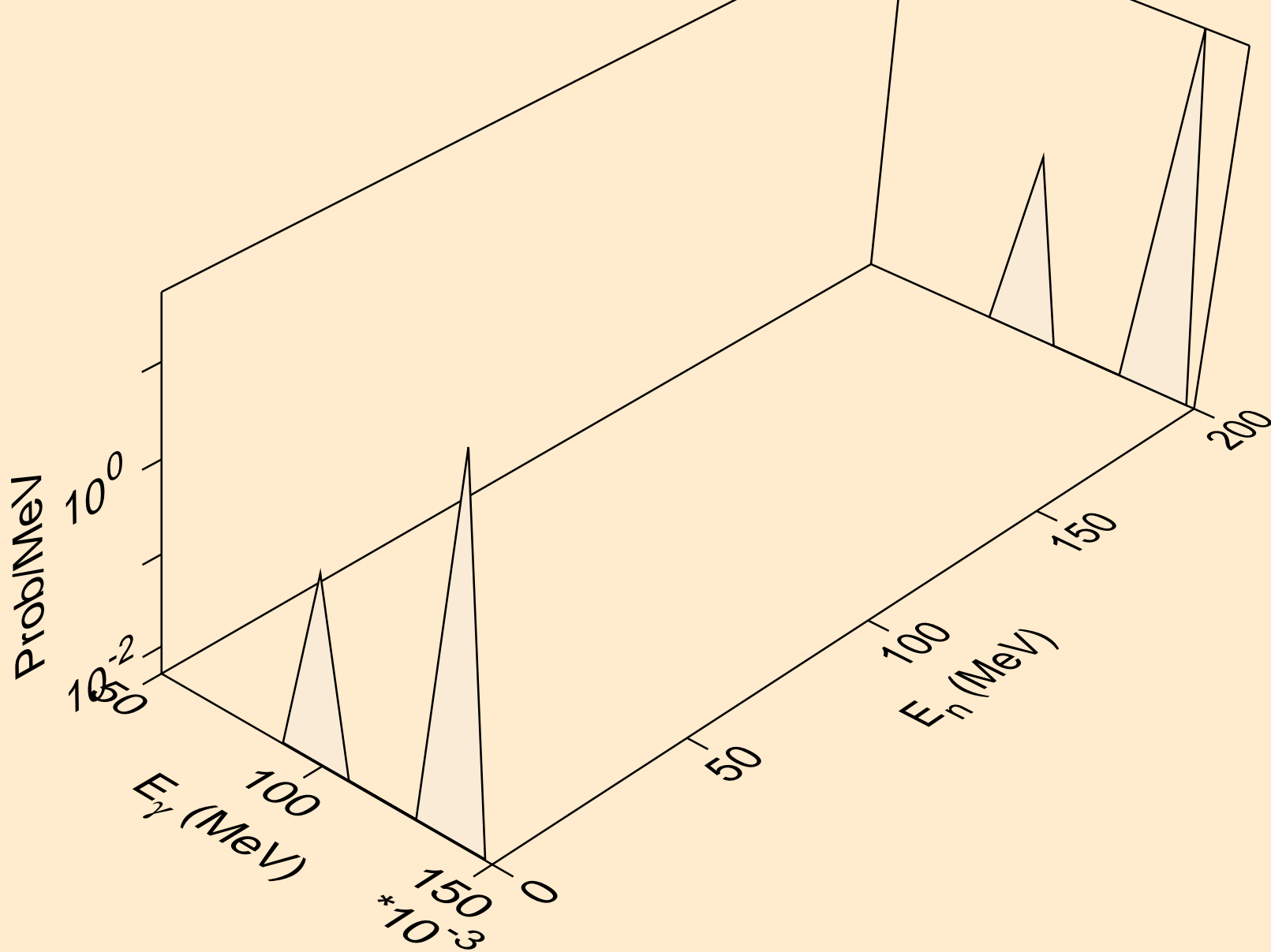

MAT=4331 ACE FILE PRODUCED AT NEA WITH NDEC
Photon emission for (n,p*3)

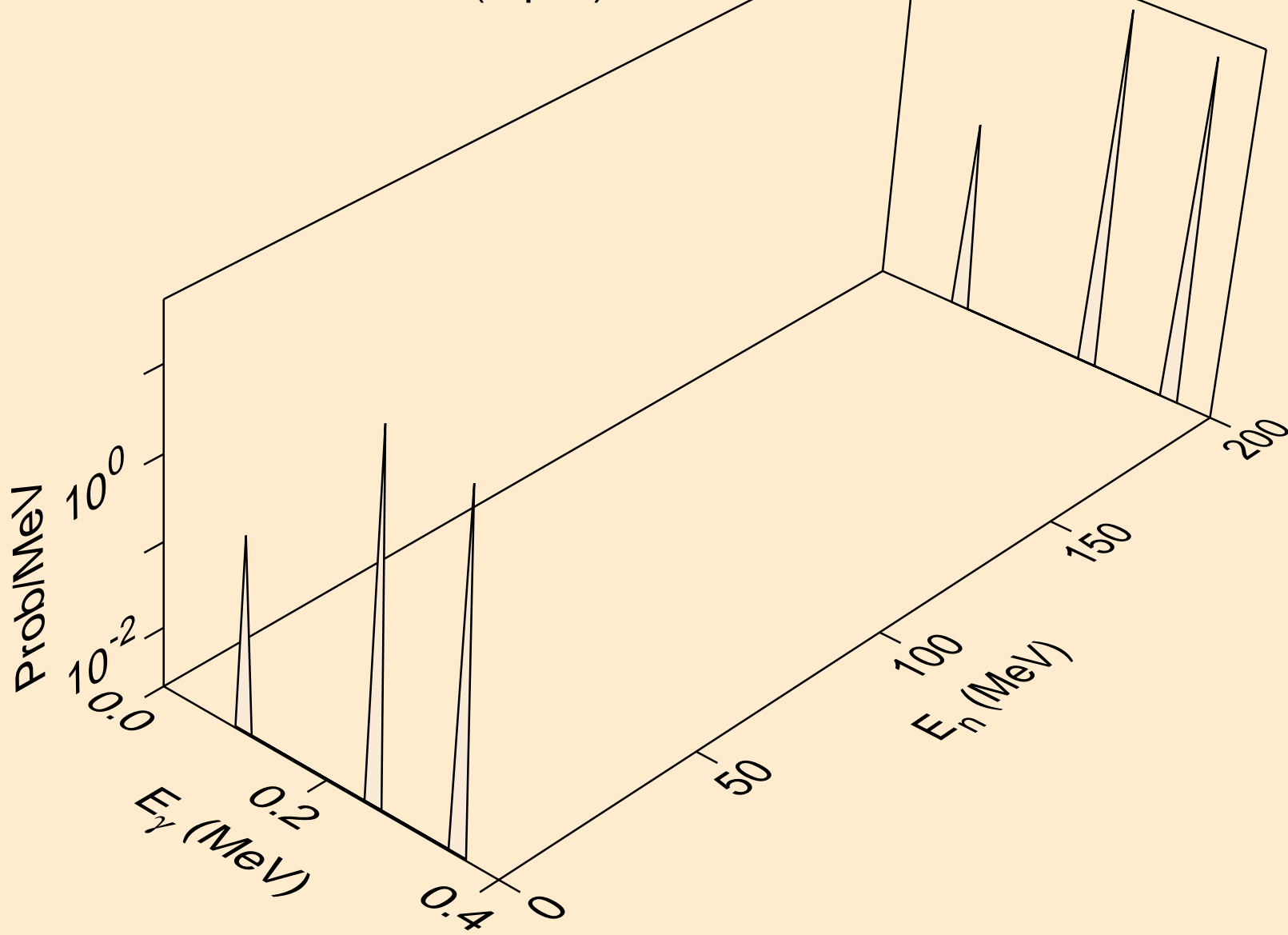

MAT=4331 ACE FILE PRODUCED AT NEA WITH NDEC
Photon emission for (n,p*4)

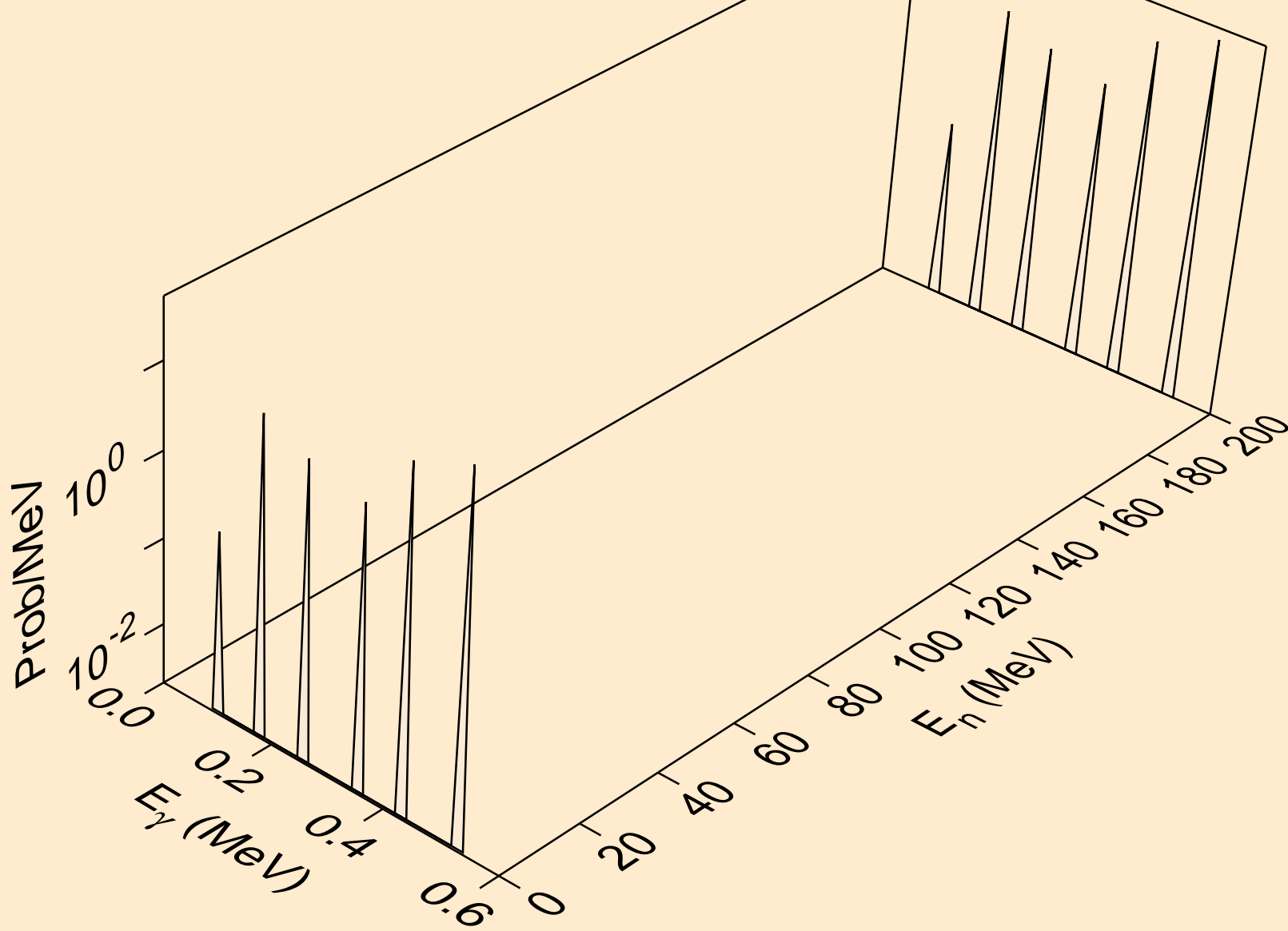

MAT=4331 ACE FILE PRODUCED AT NEA WITH NDEC
Photon emission for (n,p*5)

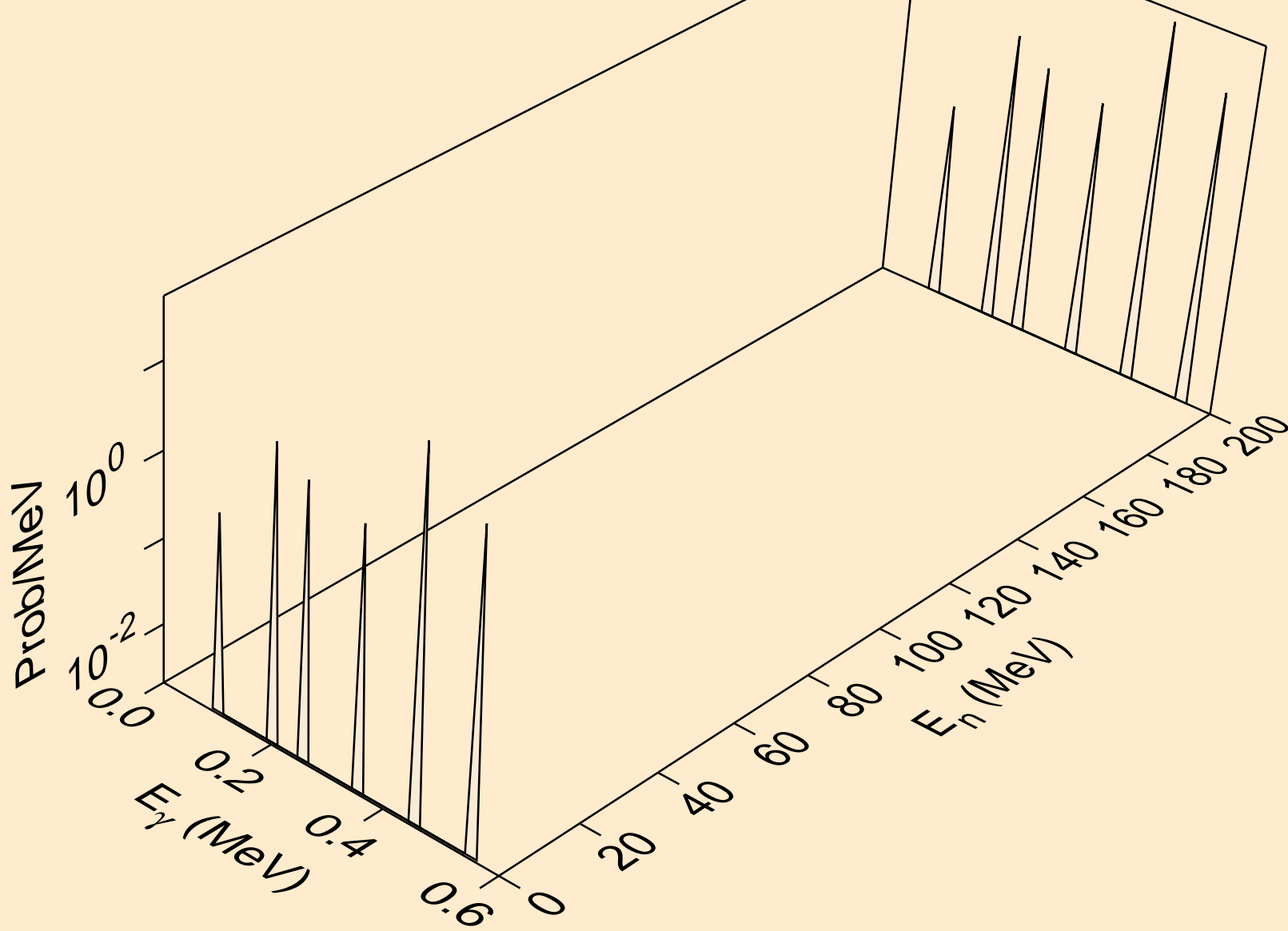

MAT=4331 ACE FILE PRODUCED AT NEA WITH NDEC
Photon emission for (n,p*6)

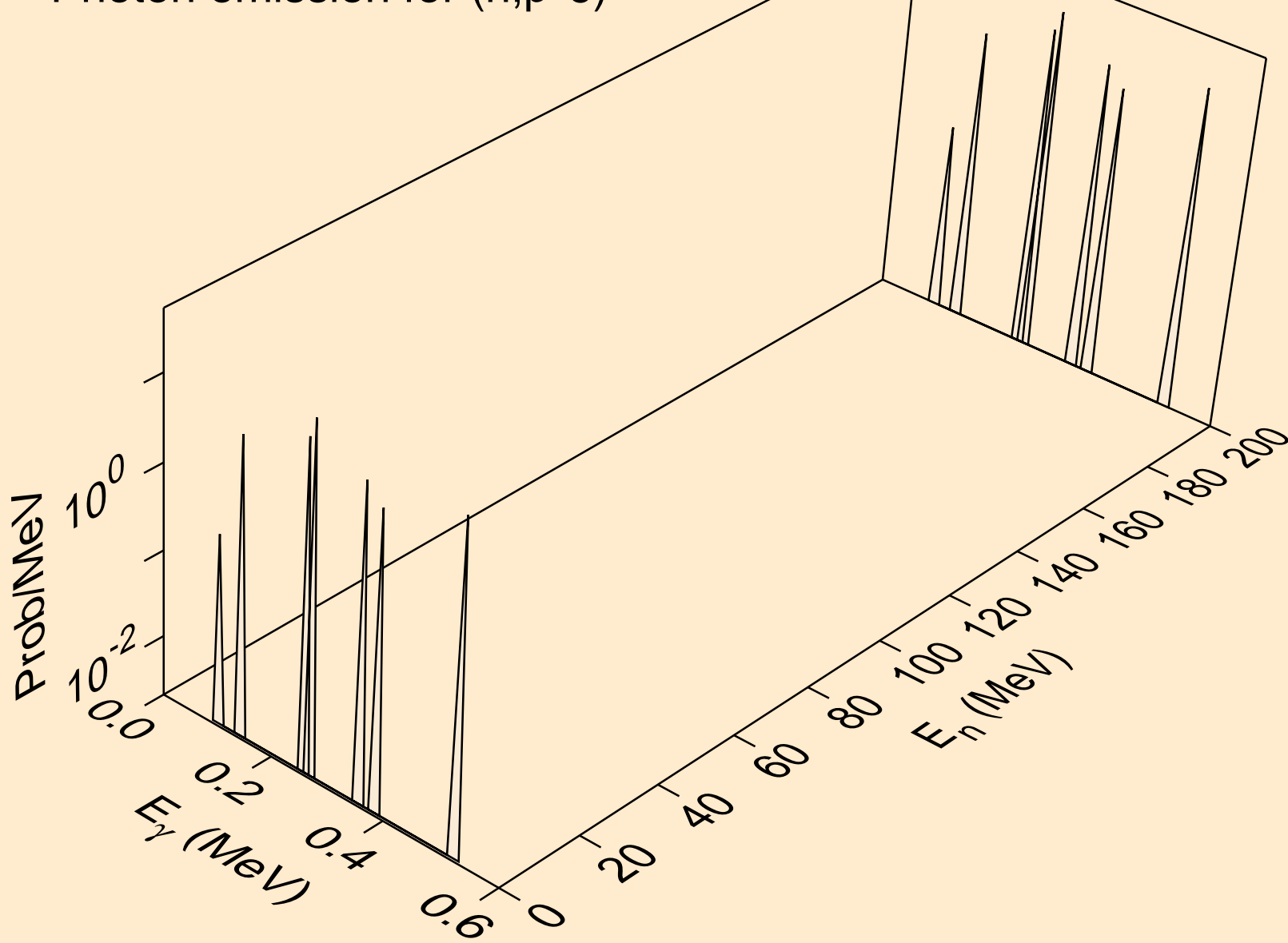

MAT=4331 ACE FILE PRODUCED AT NEA WITH NDEC
Photon emission for (n,p*7)

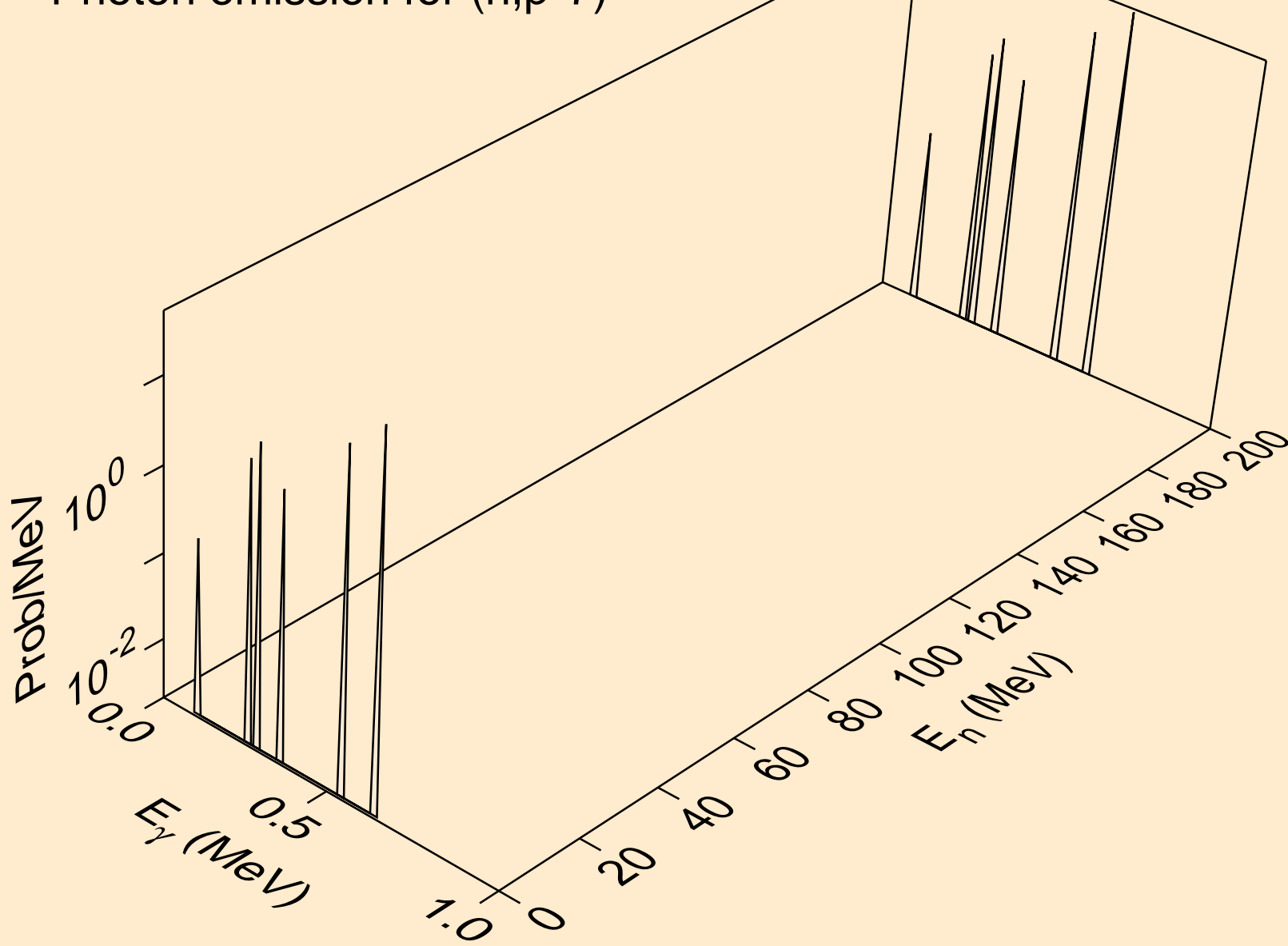

MAT=4331 ACE FILE PRODUCED AT NEA WITH NDEC
Photon emission for (n,p*8)

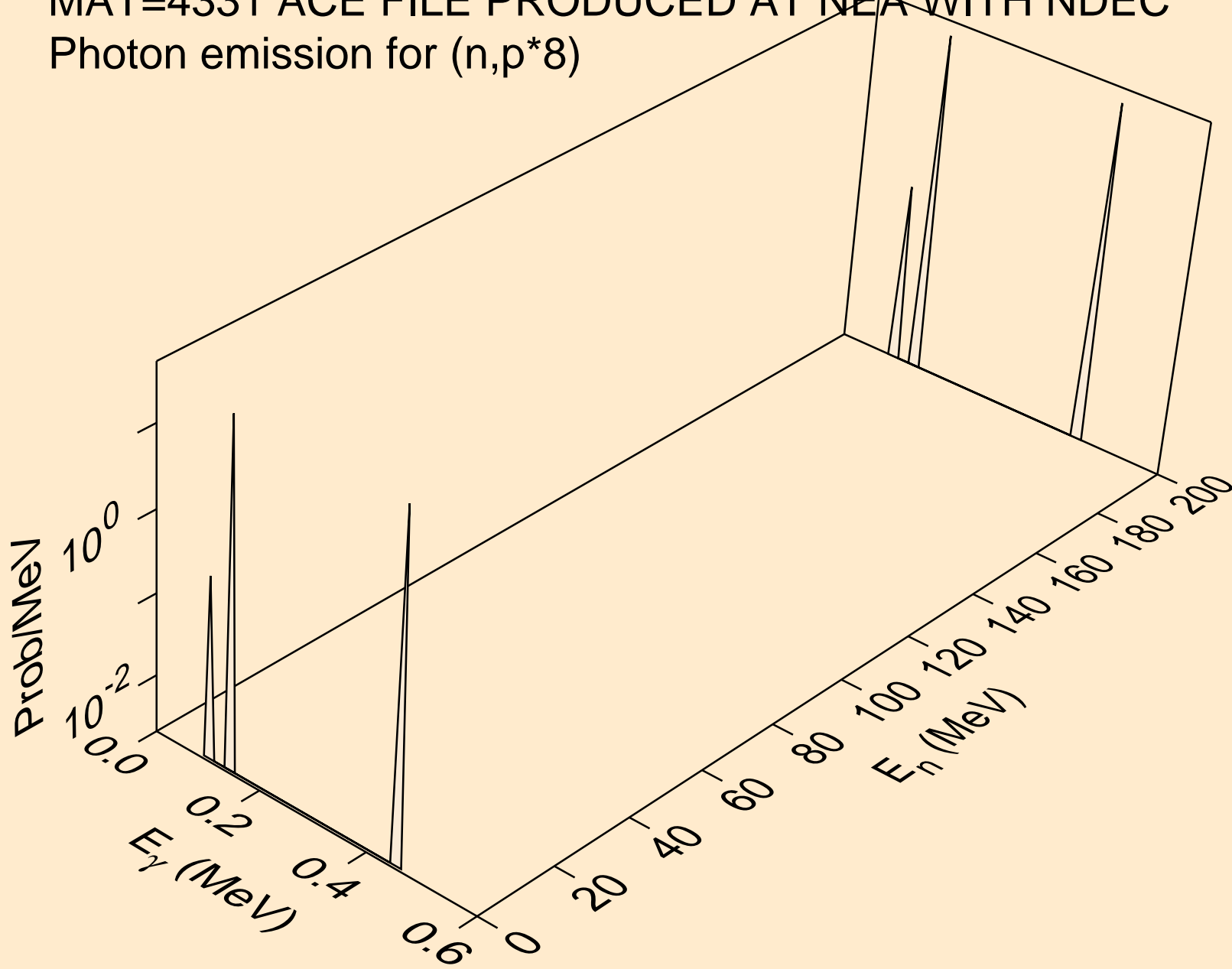

MAT=4331 ACE FILE PRODUCED AT NEA WITH NDEC
Photon emission for (n,p*9)

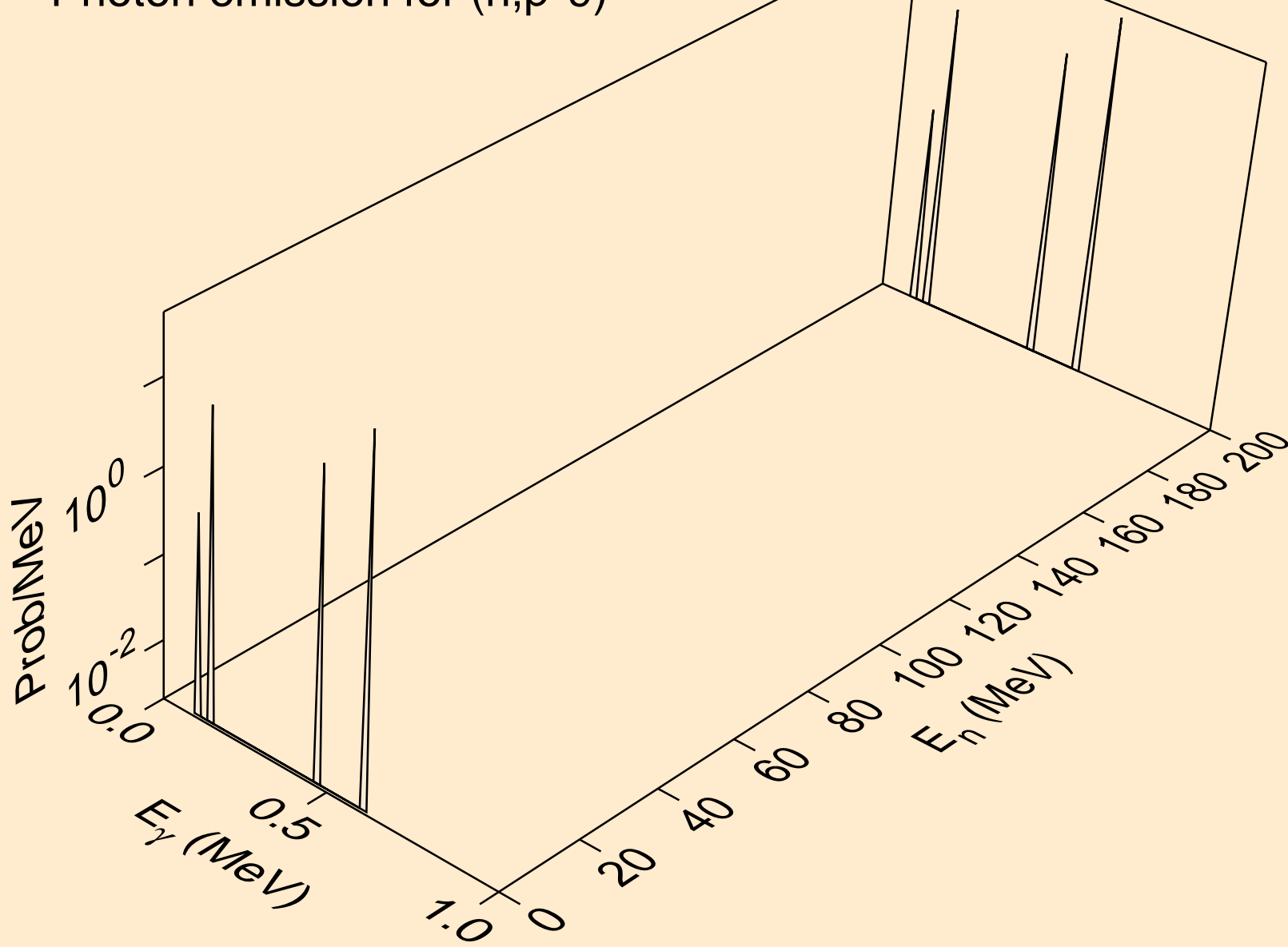

MAT=4331 ACE FILE PRODUCED AT NEA WITH NDEC
Photon emission for (n,p*10)

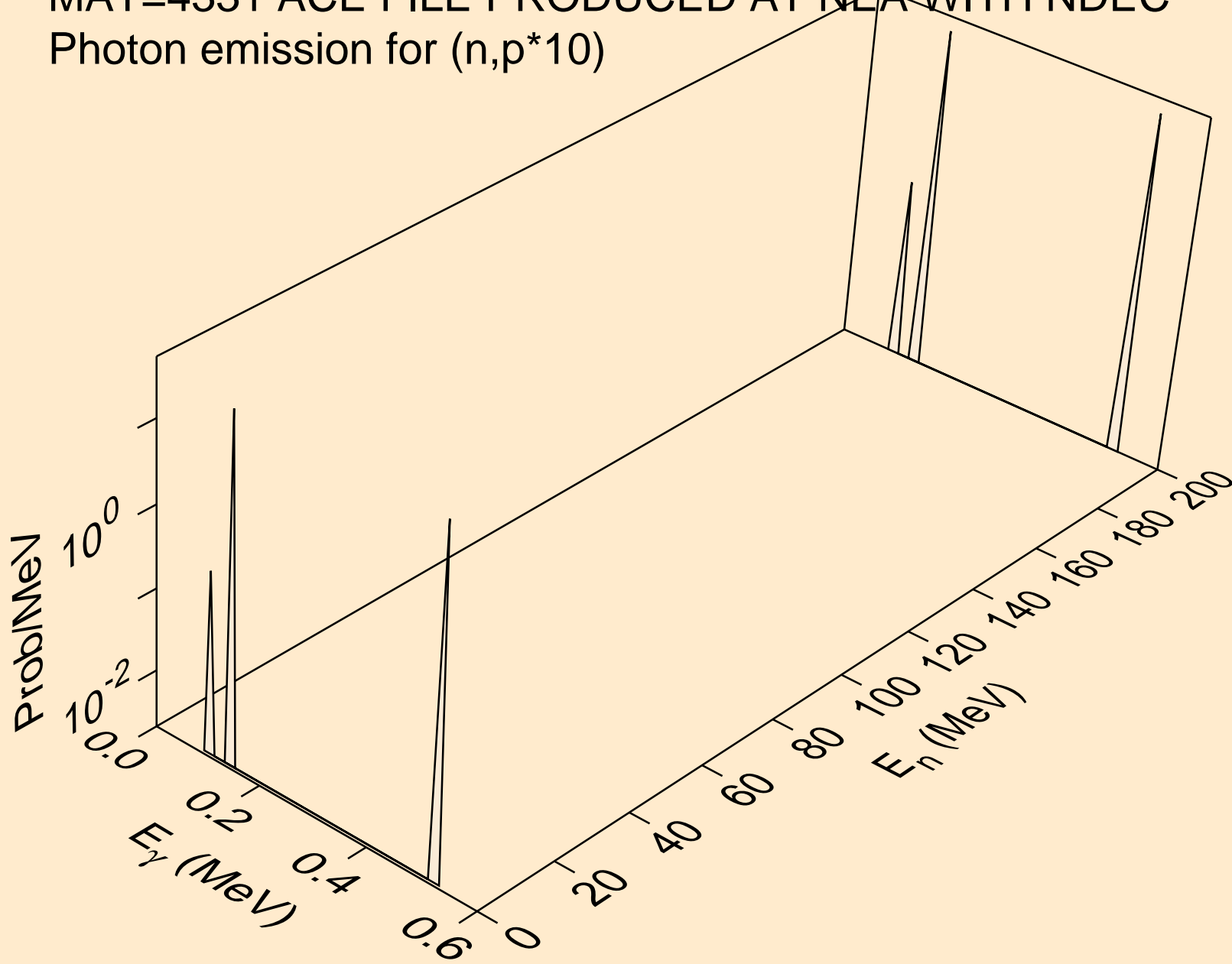

MAT=4331 ACE FILE PRODUCED AT NEA WITH NDEC
Photon emission for (n,p*c)

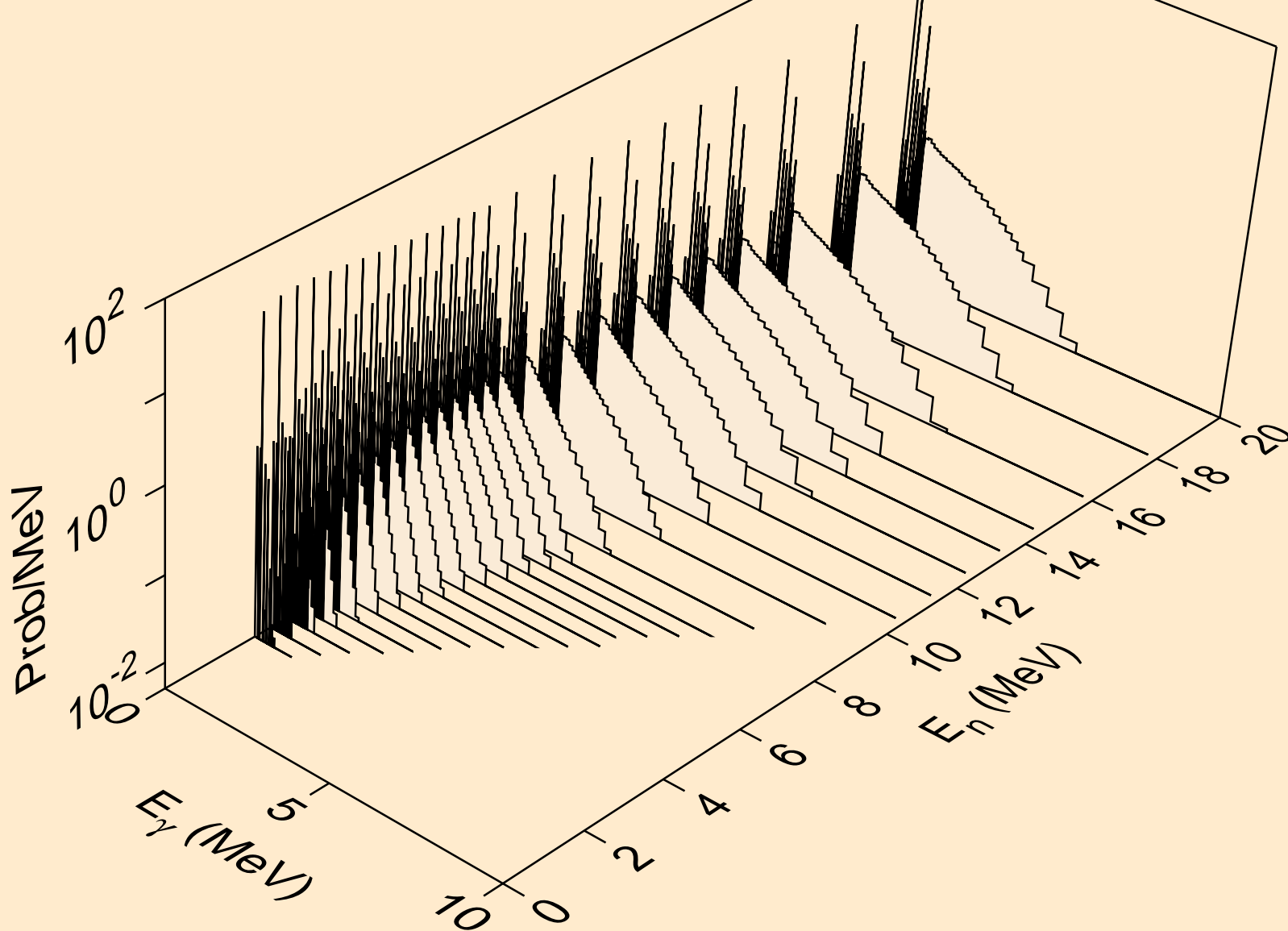

MAT=4331 ACE FILE PRODUCED AT NEA WITH NDEC
Photon emission for (n,d*1)

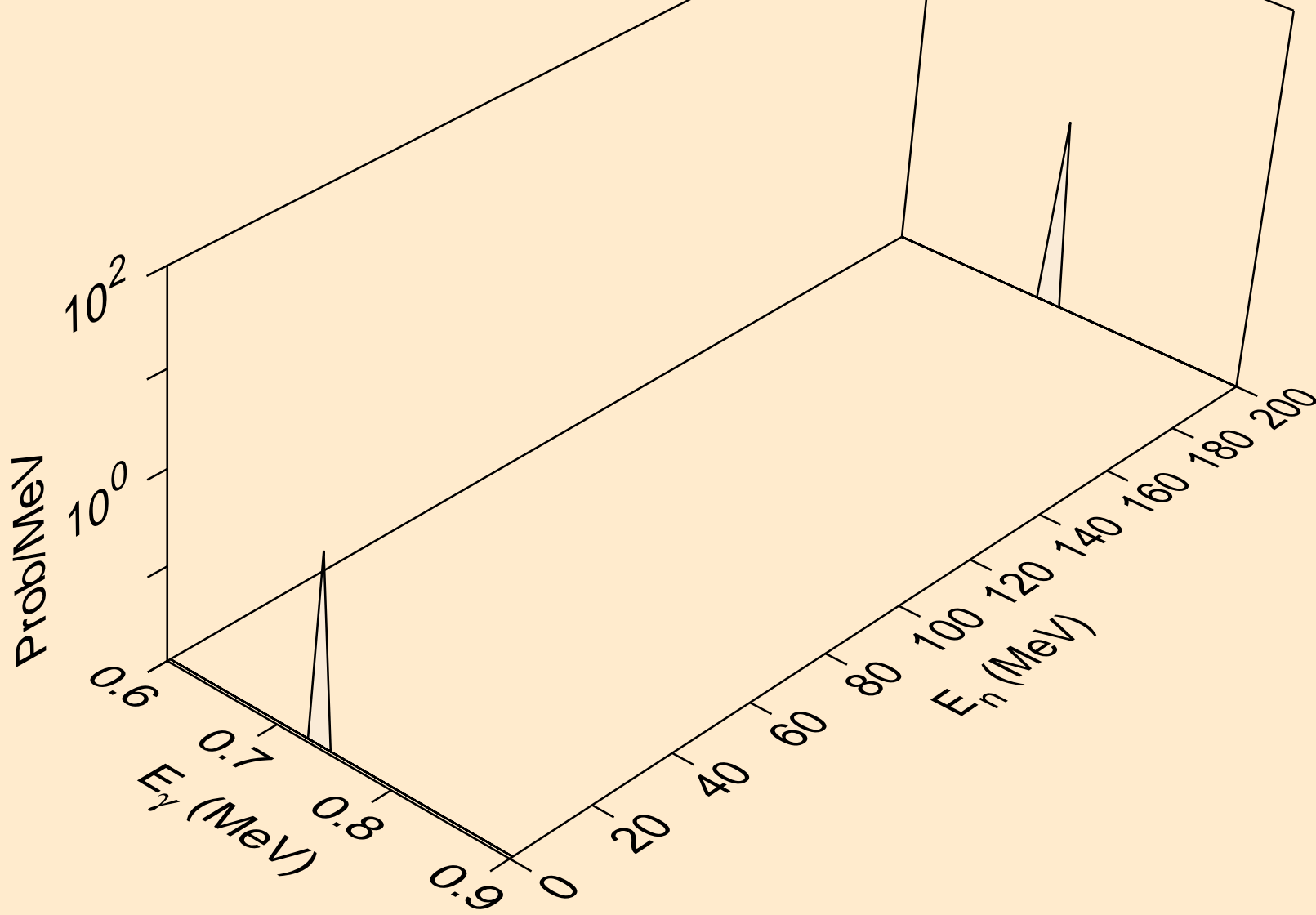

MAT=4331 ACE FILE PRODUCED AT NEA WITH NDEC
Photon emission for (n,d*2)

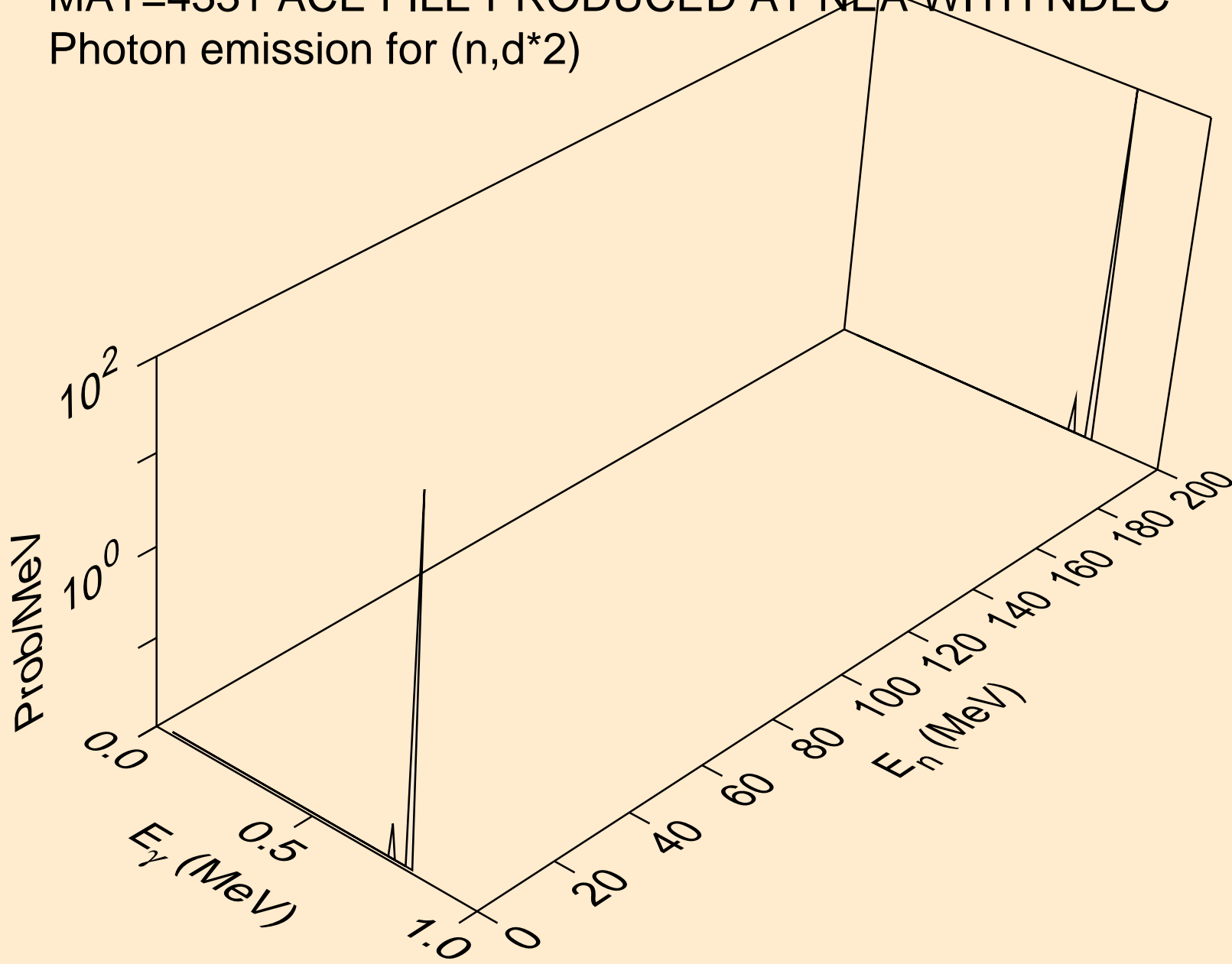

MAT=4331 ACE FILE PRODUCED AT NEA WITH NDEC
Photon emission for (n,d*3)

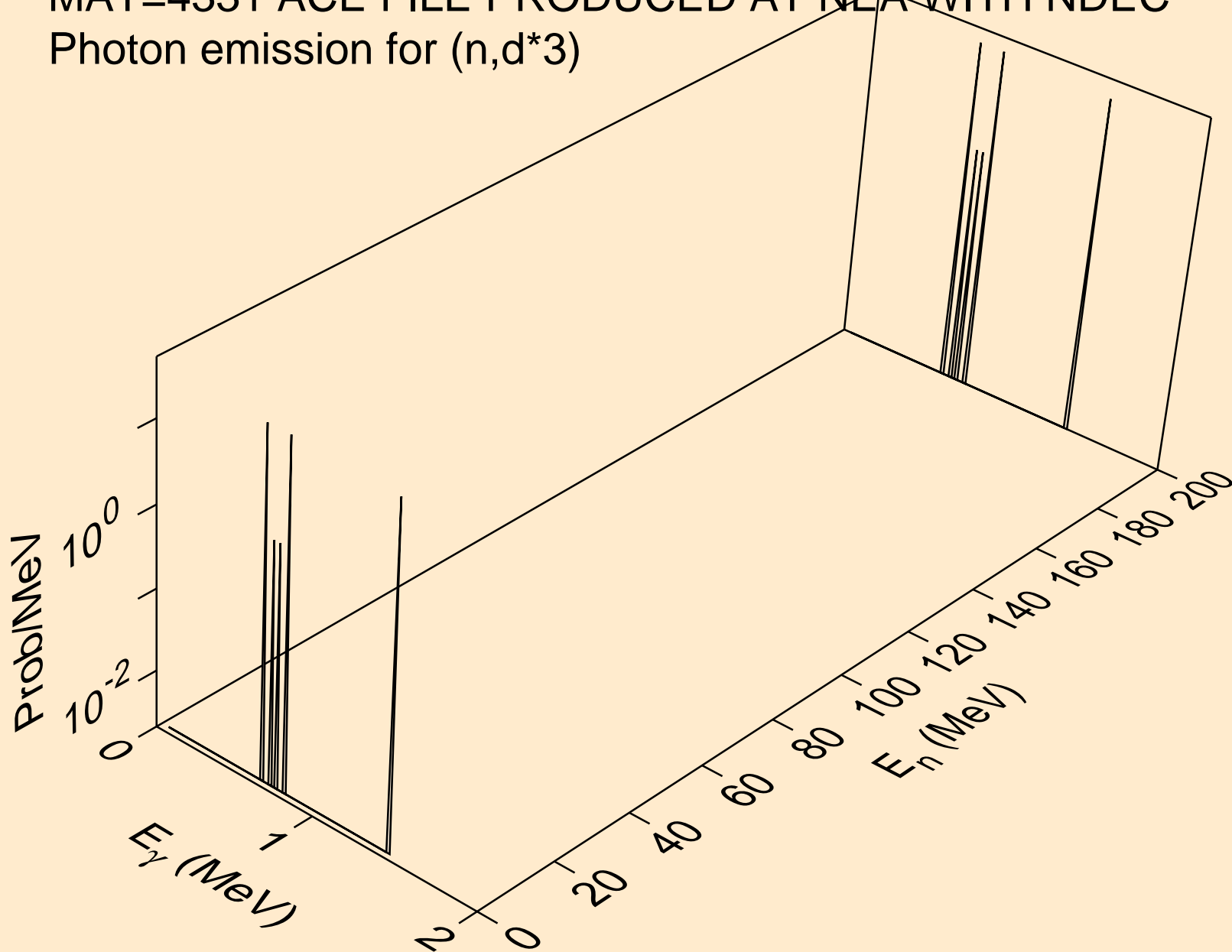

MAT=4331 ACE FILE PRODUCED AT NEA WITH NDEC
Photon emission for (n,d*4)

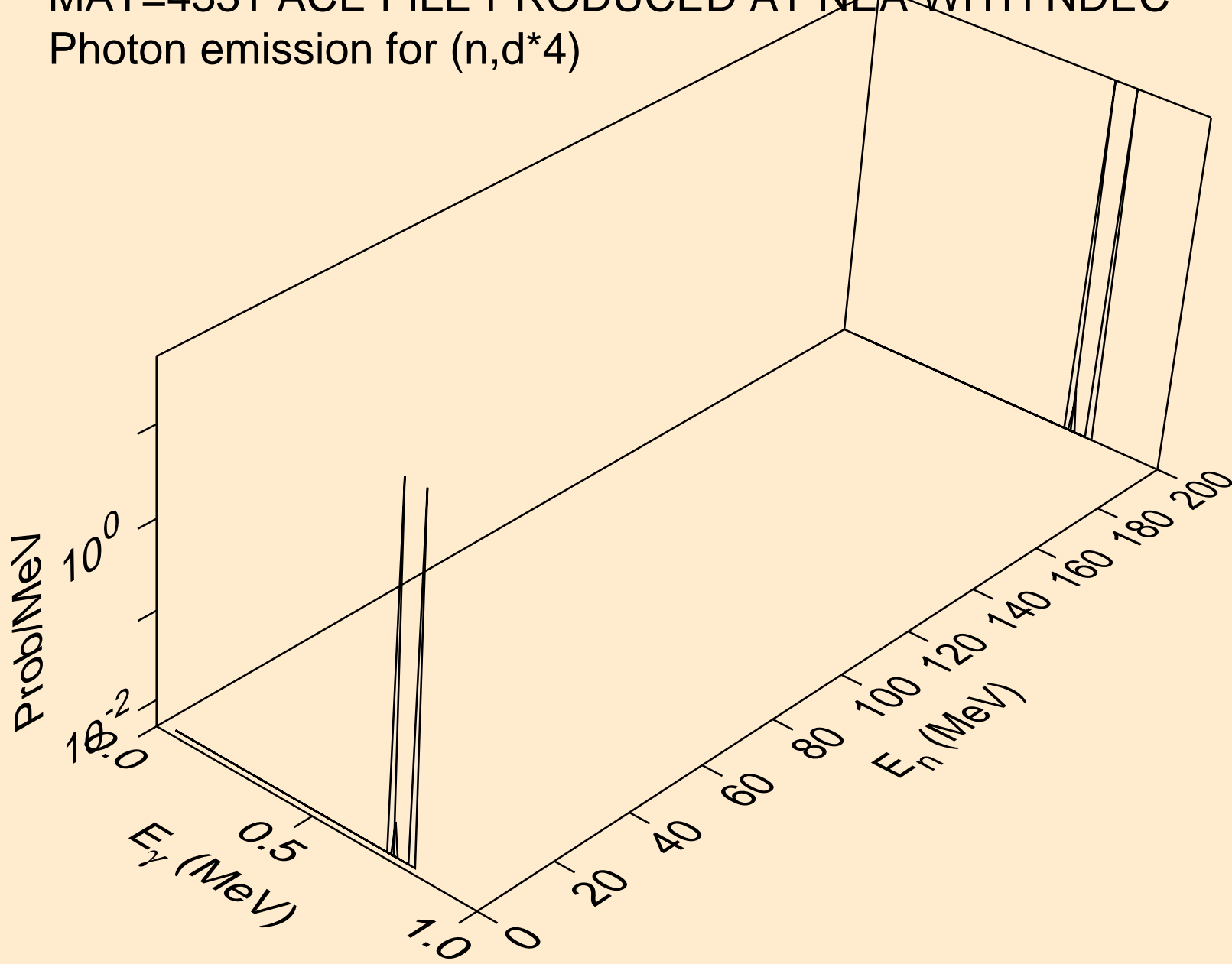

MAT=4331 ACE FILE PRODUCED AT NEA WITH NDEC
Photon emission for (n,d*5)

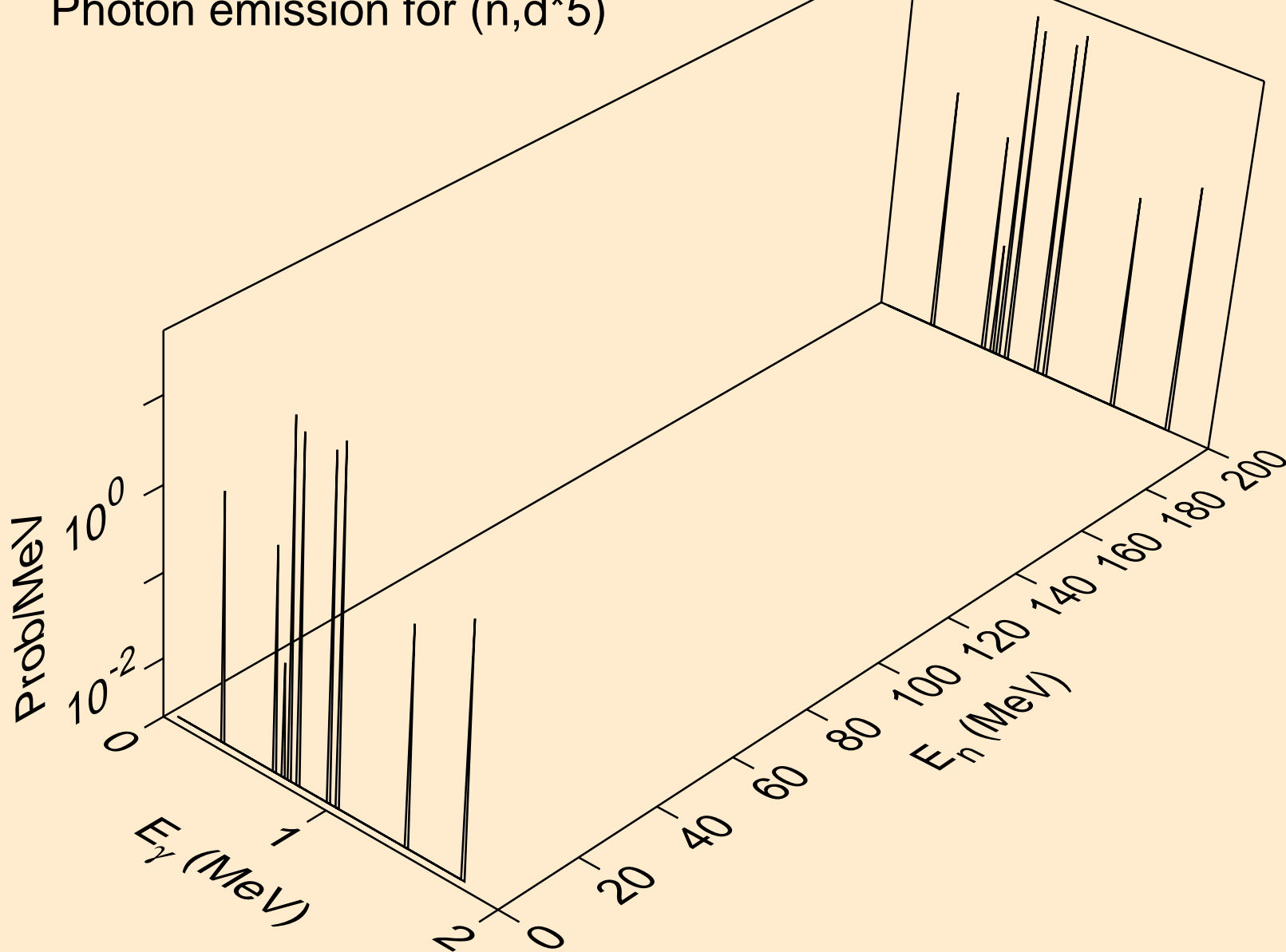

MAT=4331 ACE FILE PRODUCED AT NEA WITH NDEC
Photon emission for (n,d*c)

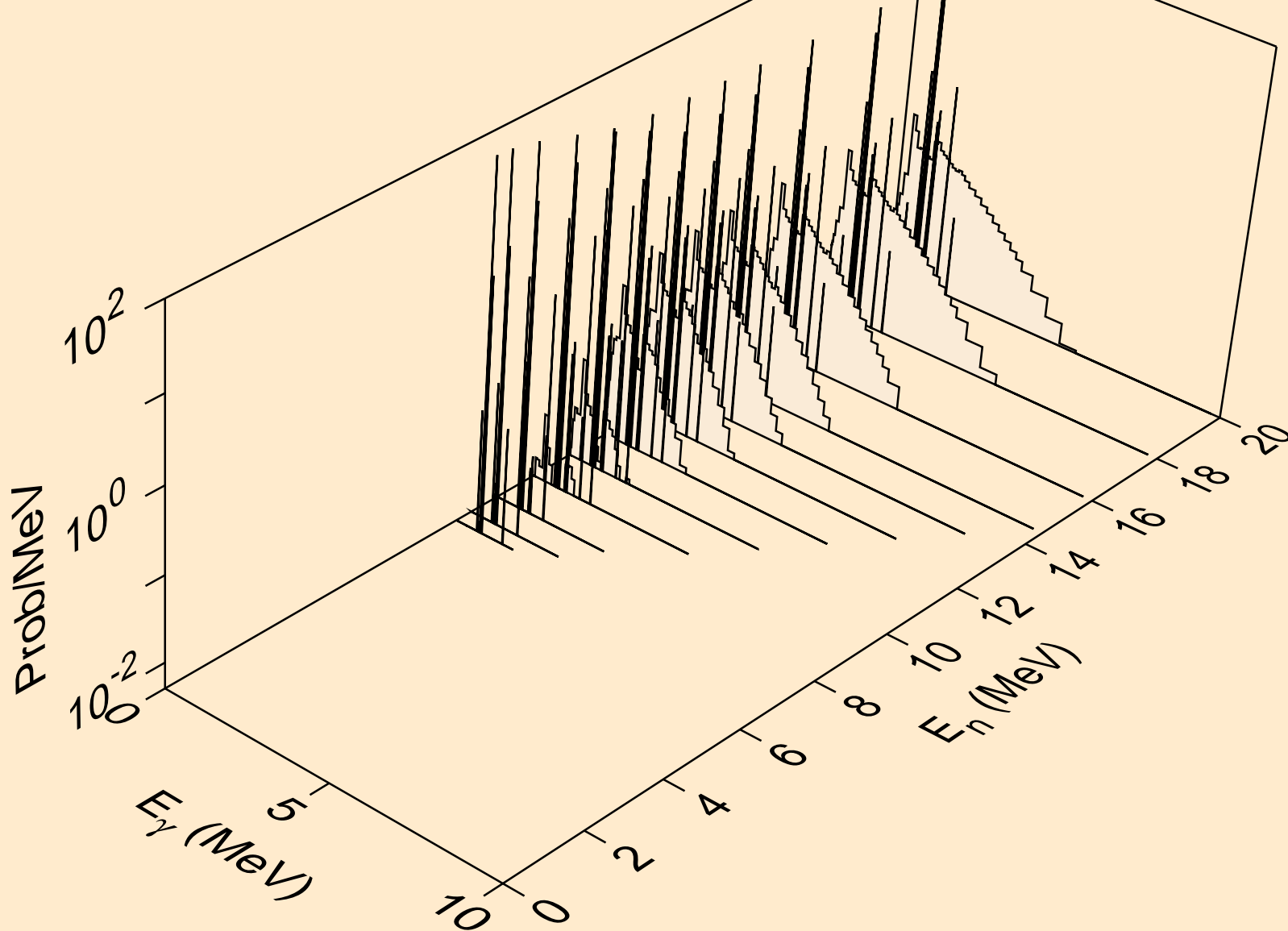

MAT=4331 ACE FILE PRODUCED AT NEA WITH NDEC
Photon emission for (n,t*1)

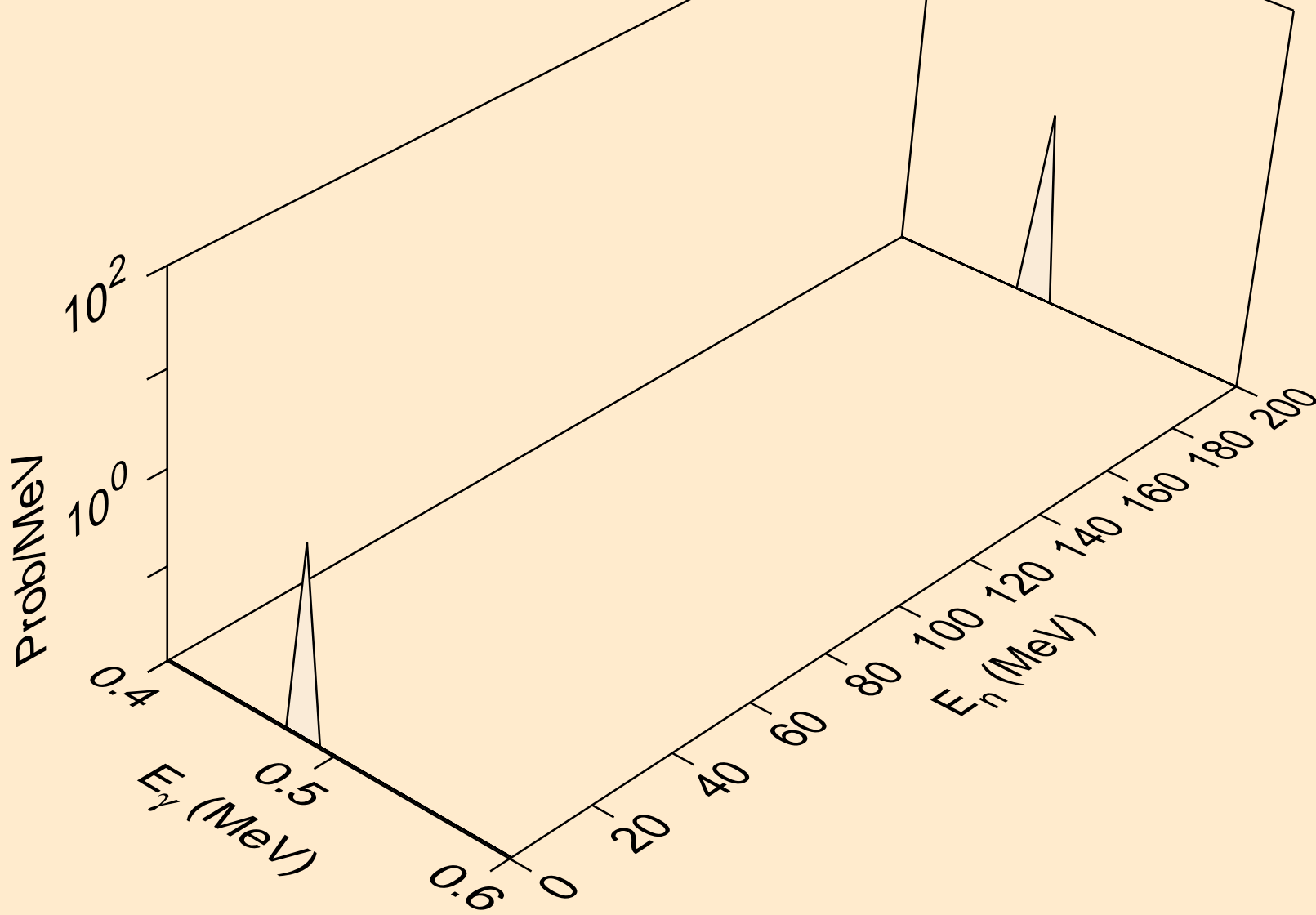

MAT=4331 ACE FILE PRODUCED AT NEA WITH NDEC
Photon emission for (n,t*2)

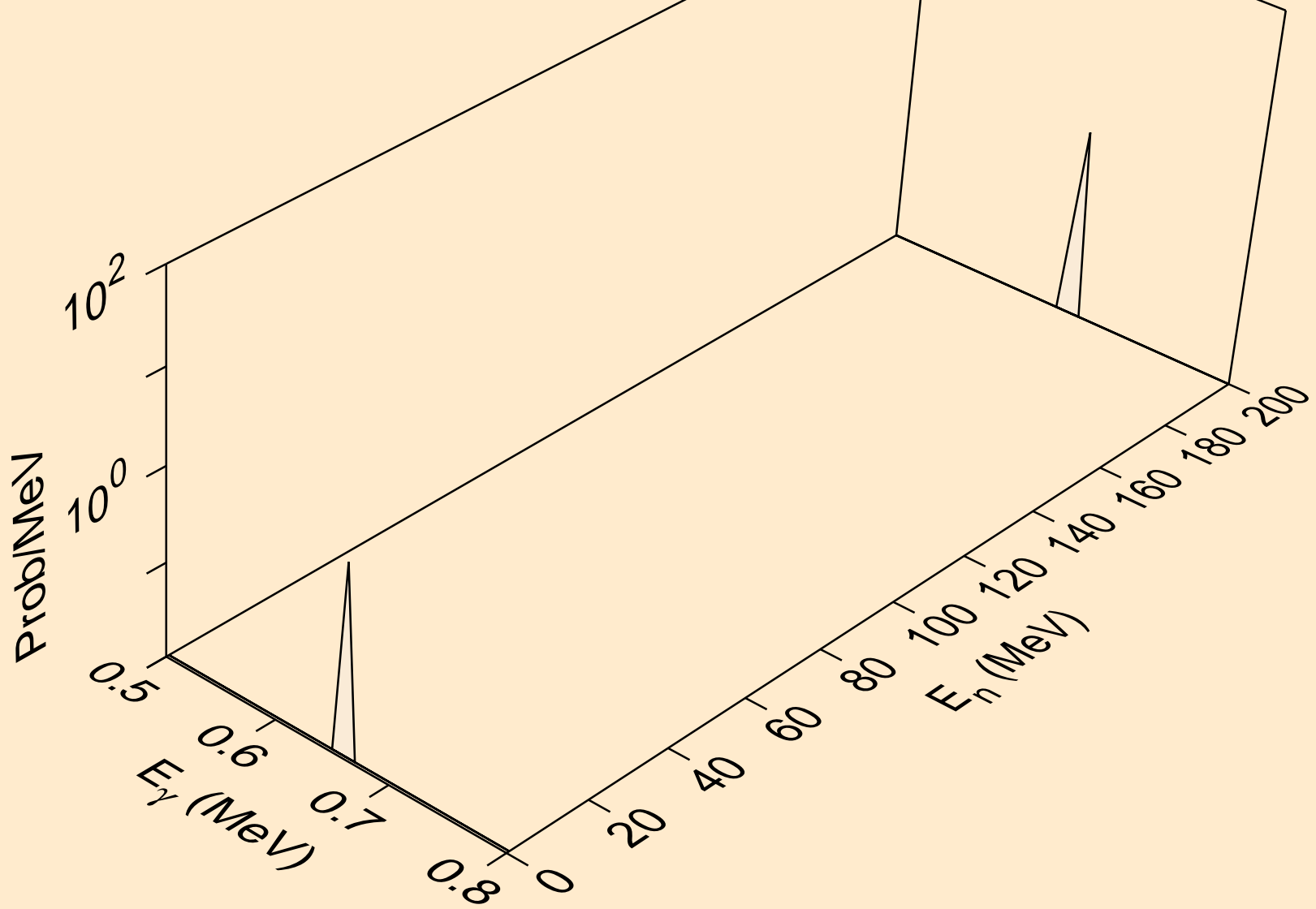

MAT=4331 ACE FILE PRODUCED AT NEA WITH NDEC
Photon emission for (n,t*3)

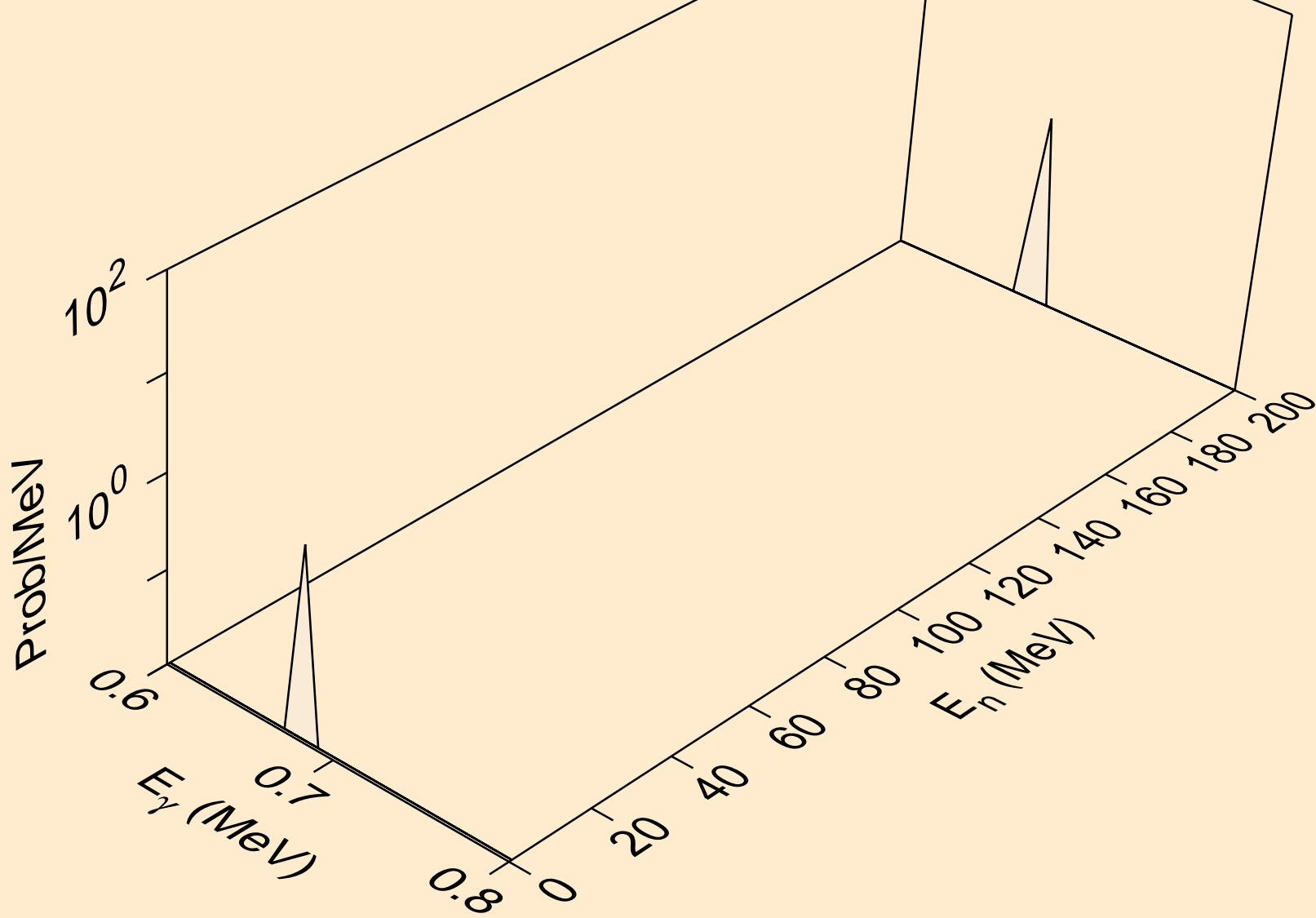

MAT=4331 ACE FILE PRODUCED AT NEA WITH NDEC
Photon emission for (n,t*4)

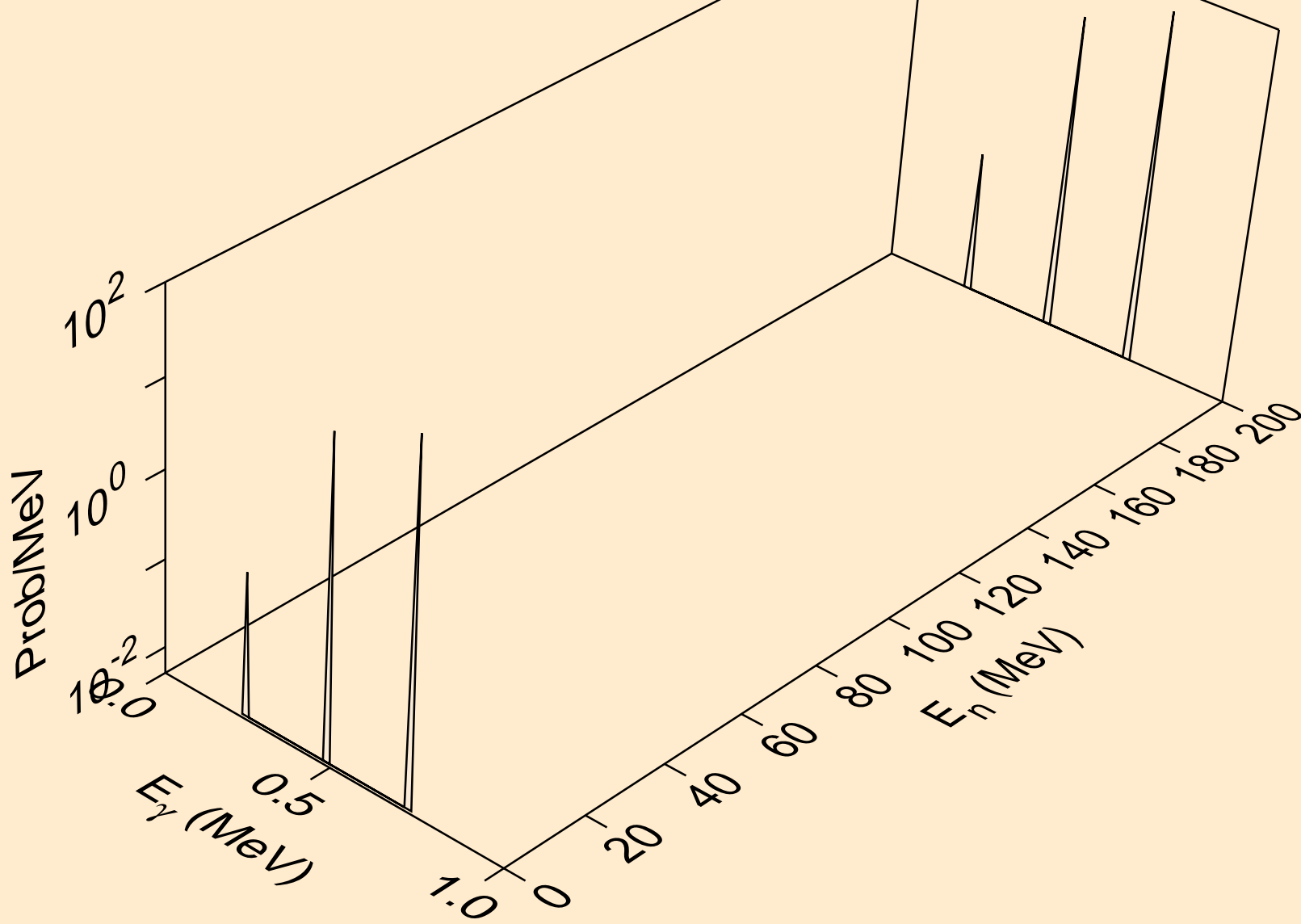

MAT=4331 ACE FILE PRODUCED AT NEA WITH NDEC
Photon emission for (n,t*5)

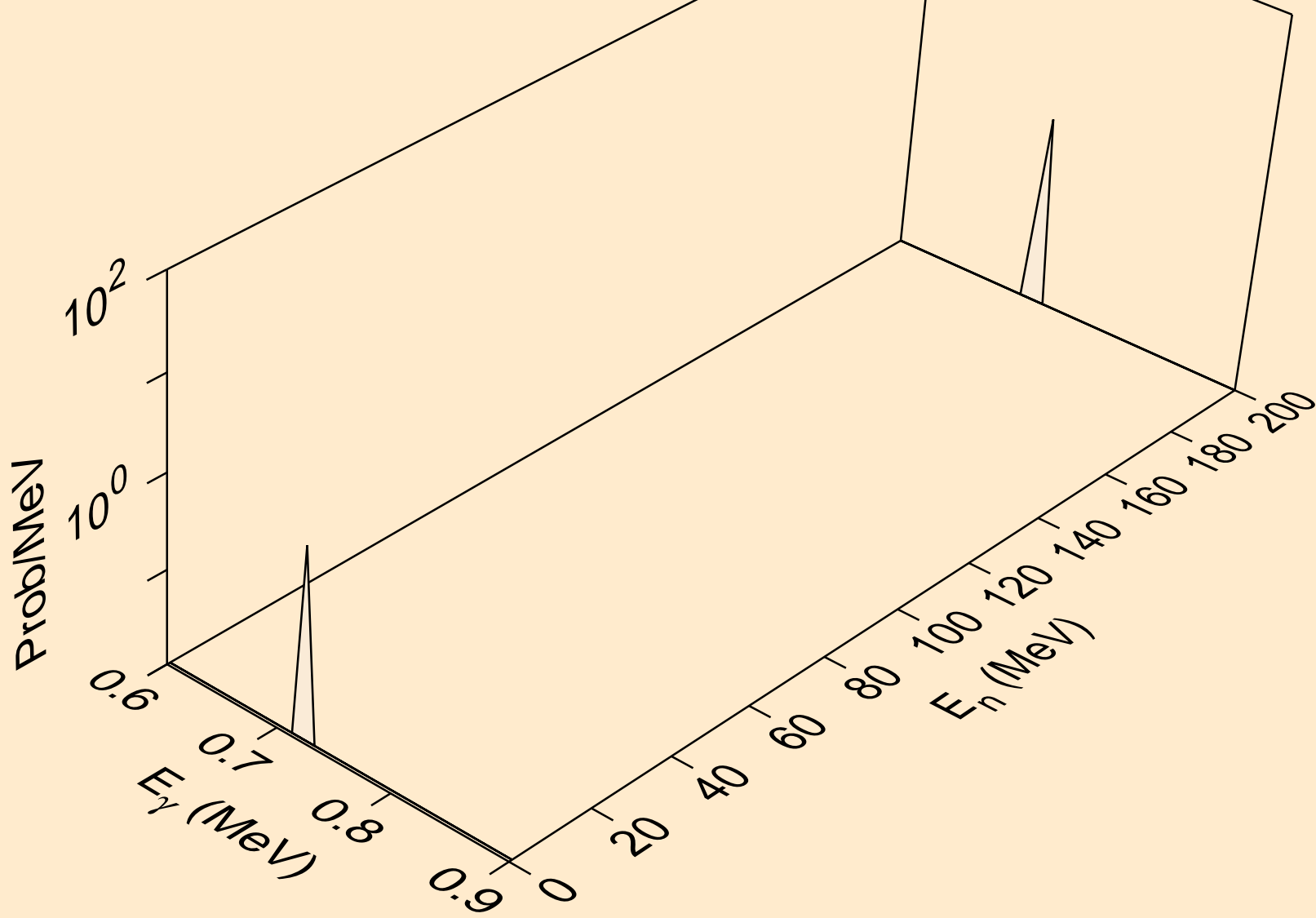

MAT=4331 ACE FILE PRODUCED AT NEA WITH NDEC
Photon emission for (n,t*c)

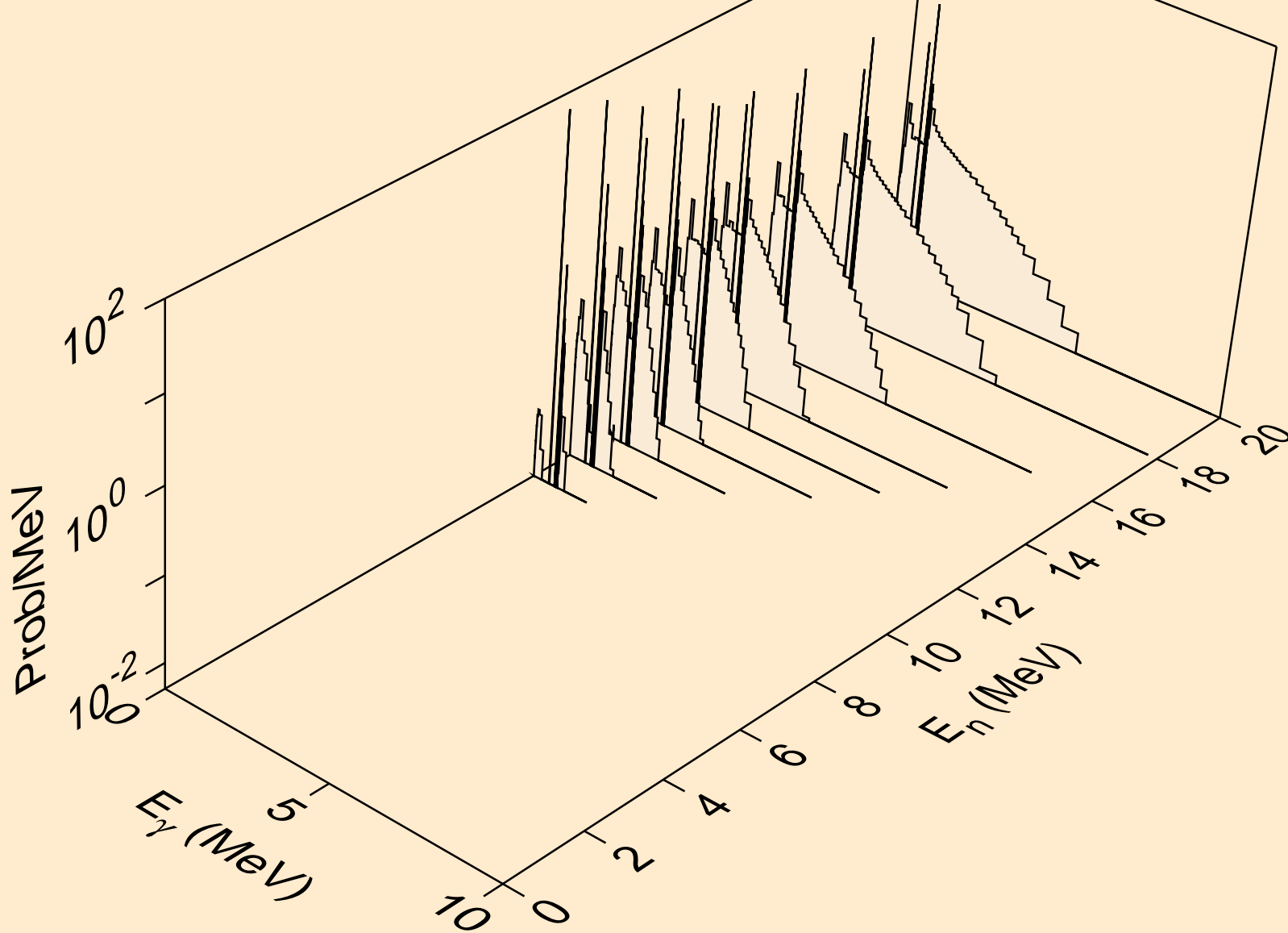

MAT=4331 ACE FILE PRODUCED AT NEA WITH NDEC
Photon emission for (n,he3*2)

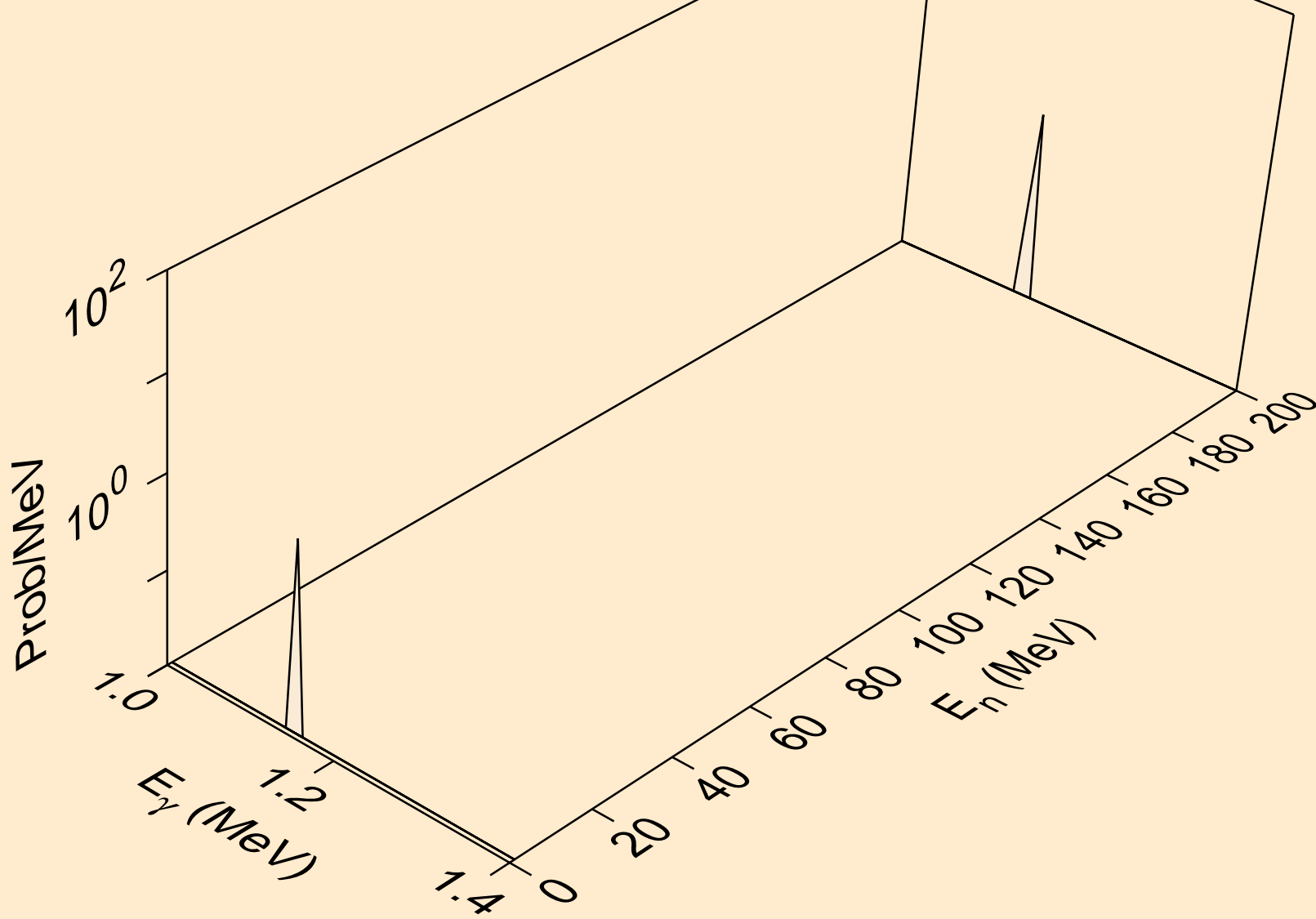

MAT=4331 ACE FILE PRODUCED AT NEA WITH NDEC
Photon emission for (n,he3*3)

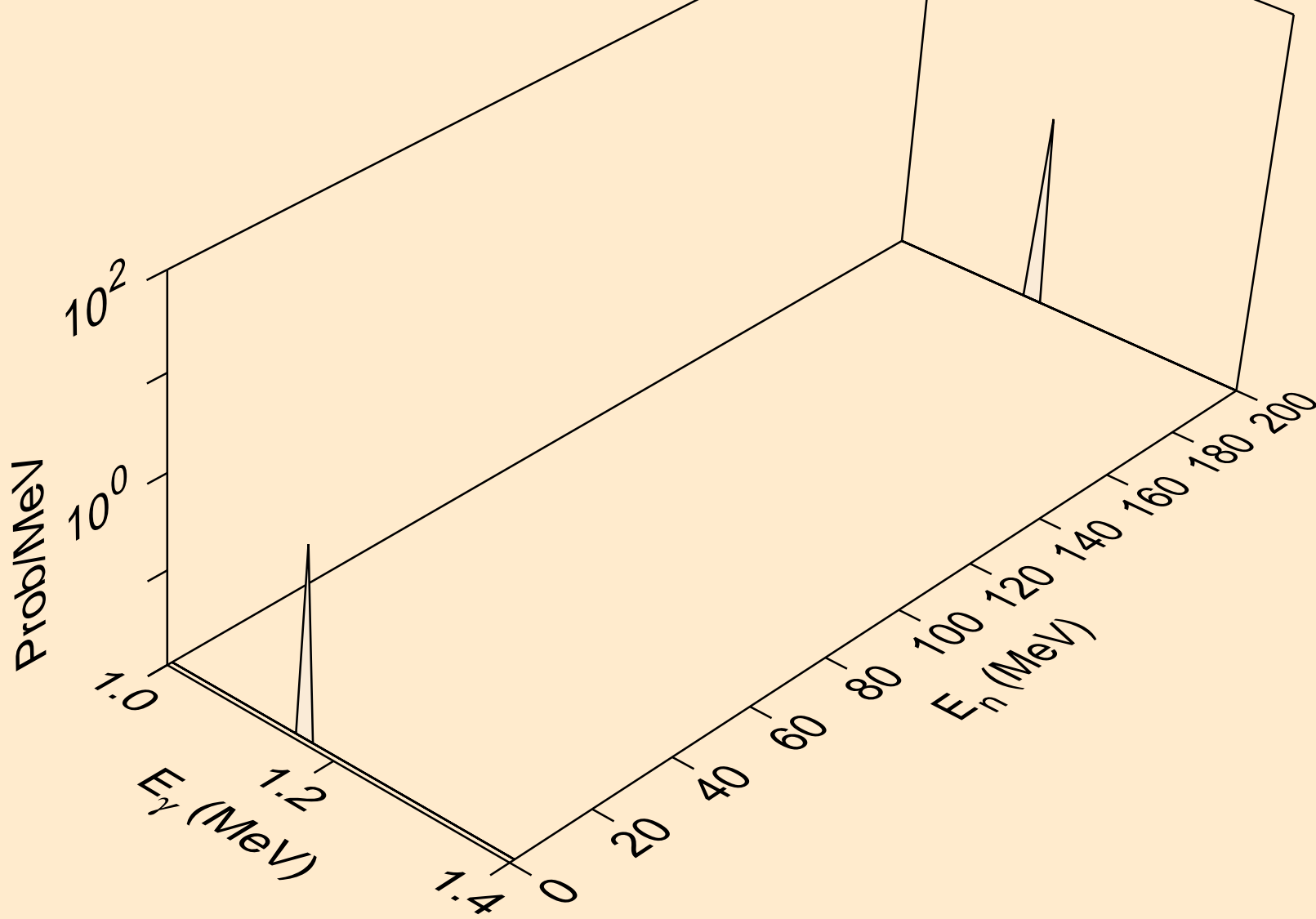

MAT=4331 ACE FILE PRODUCED AT NEA WITH NDEC
Photon emission for (n,he3*4)

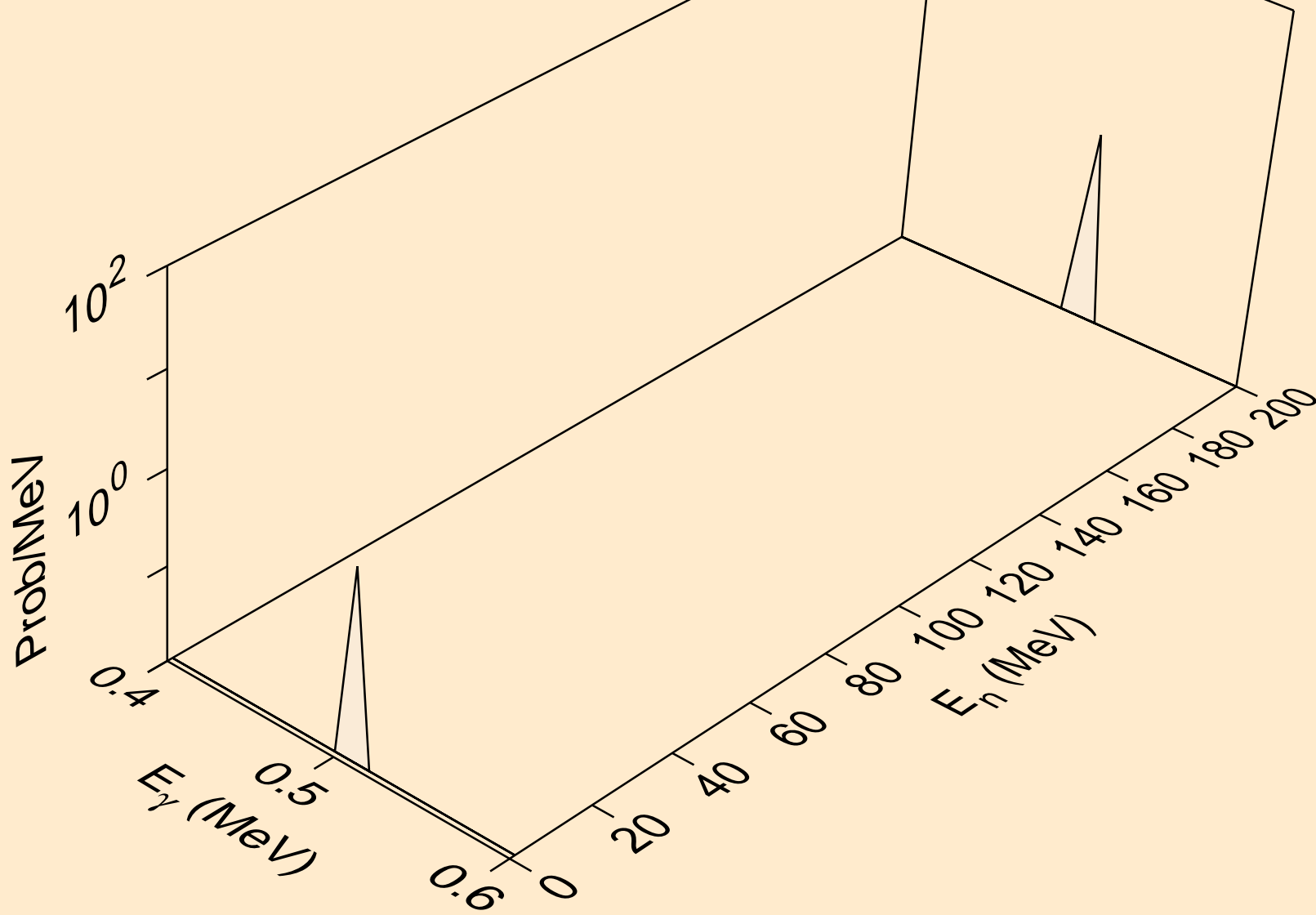

MAT=4331 ACE FILE PRODUCED AT NEA WITH NDEC
Photon emission for (n,he3*5)

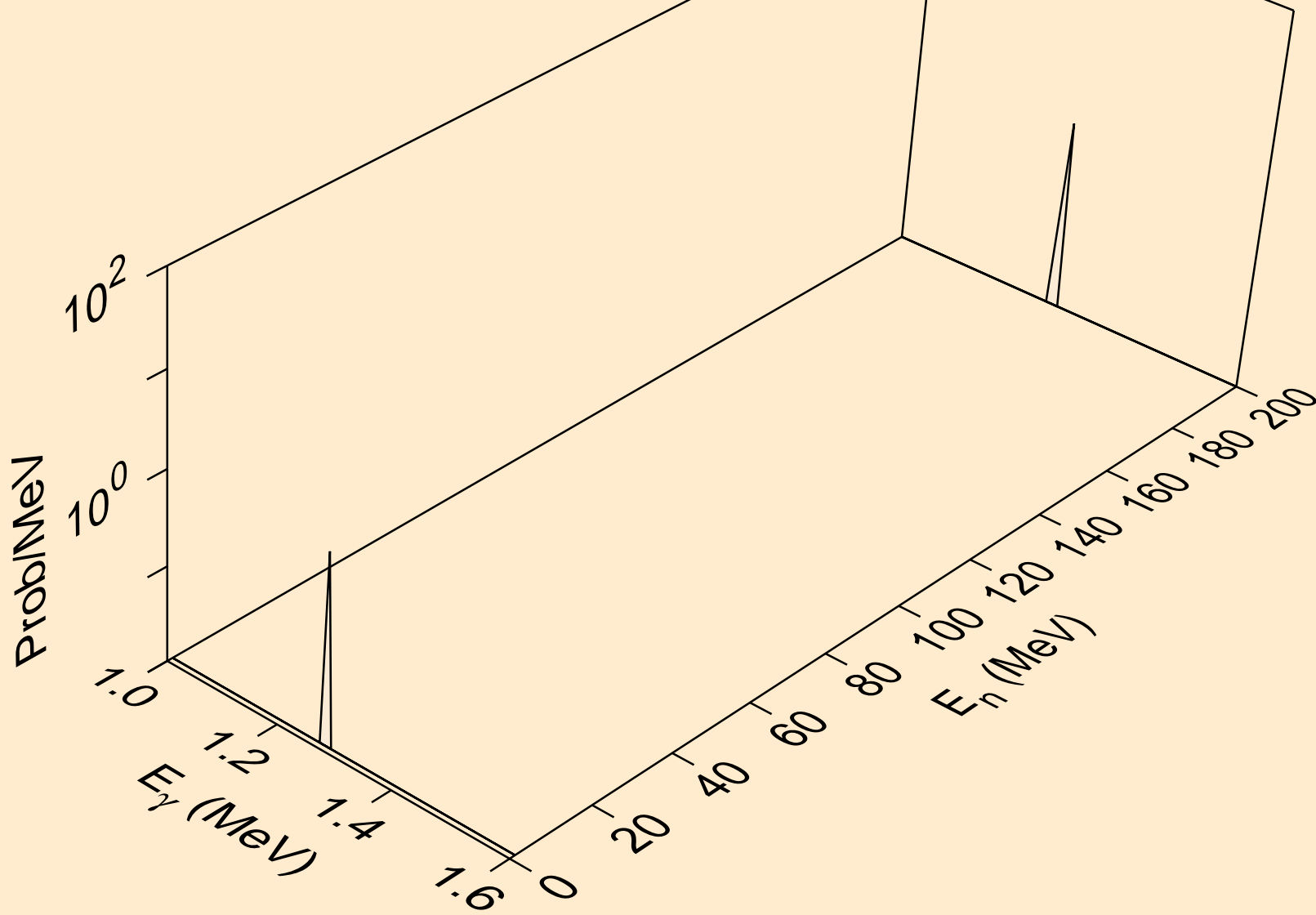

MAT=4331 ACE FILE PRODUCED AT NEA WITH NDEC
Photon emission for (n,he3*c)

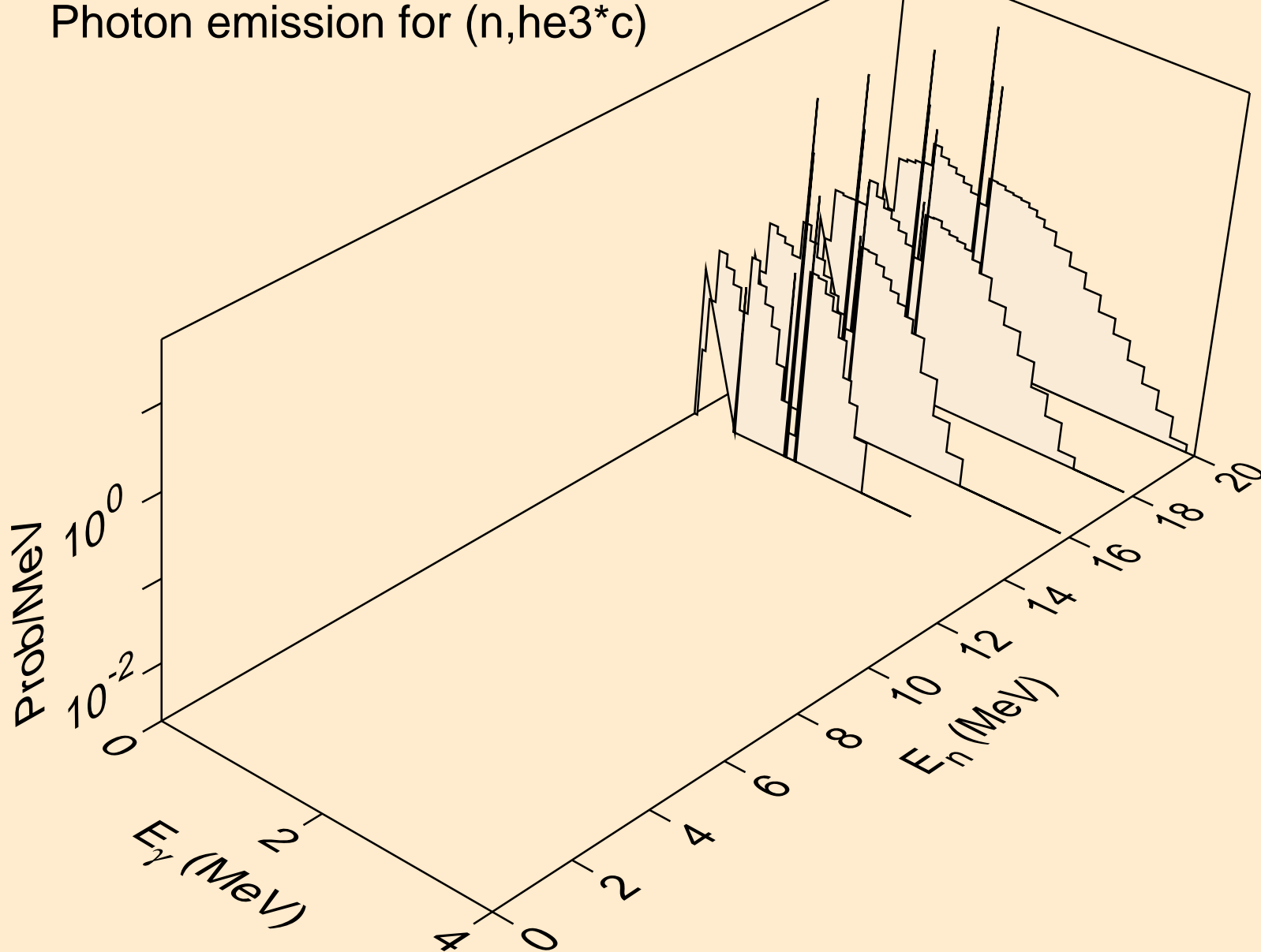

MAT=4331 ACE FILE PRODUCED AT NEA WITH NDEC
Photon emission for (n,a*1)

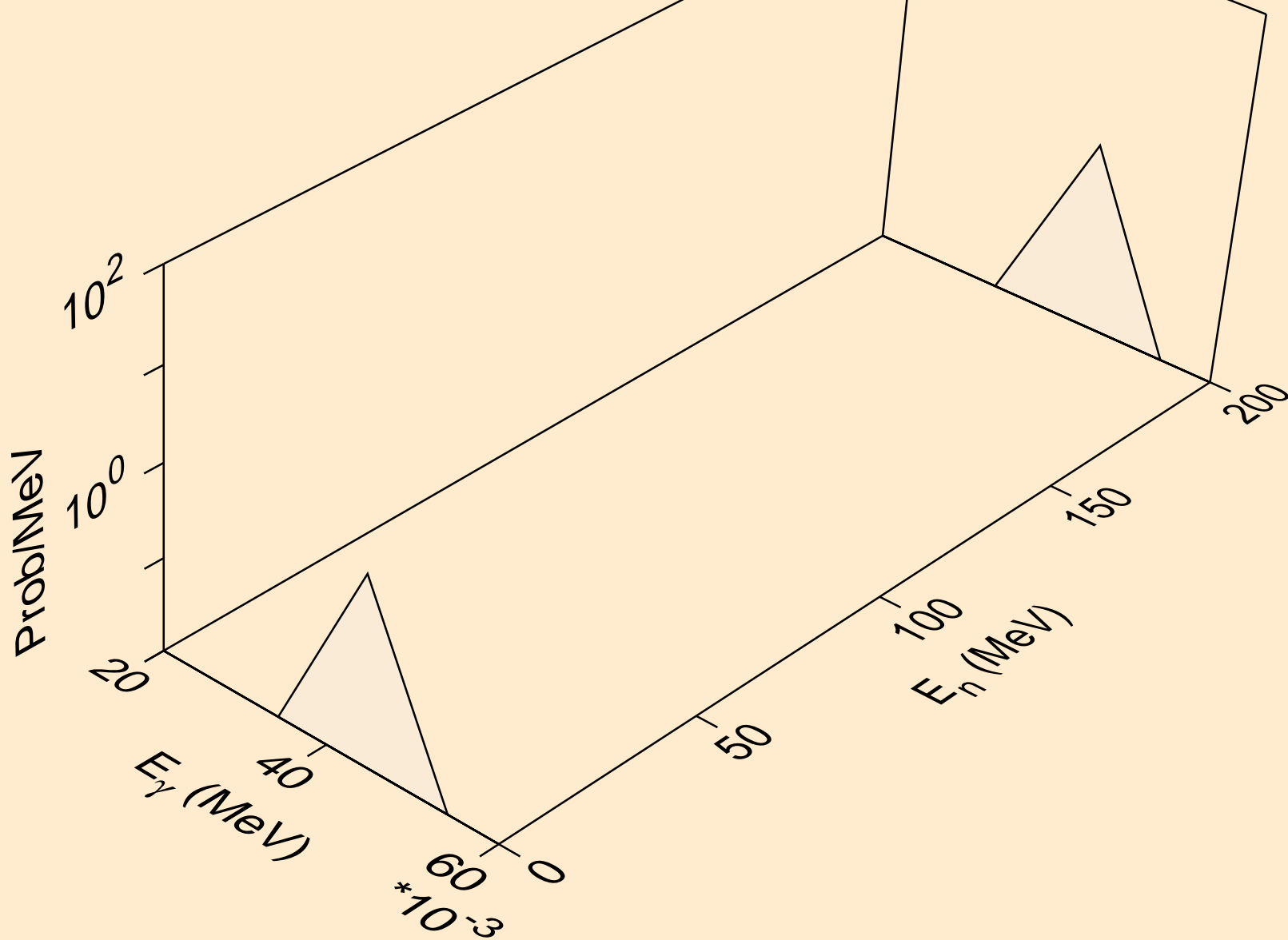

MAT=4331 ACE FILE PRODUCED AT NEA WITH NDEC
Photon emission for (n,a*2)

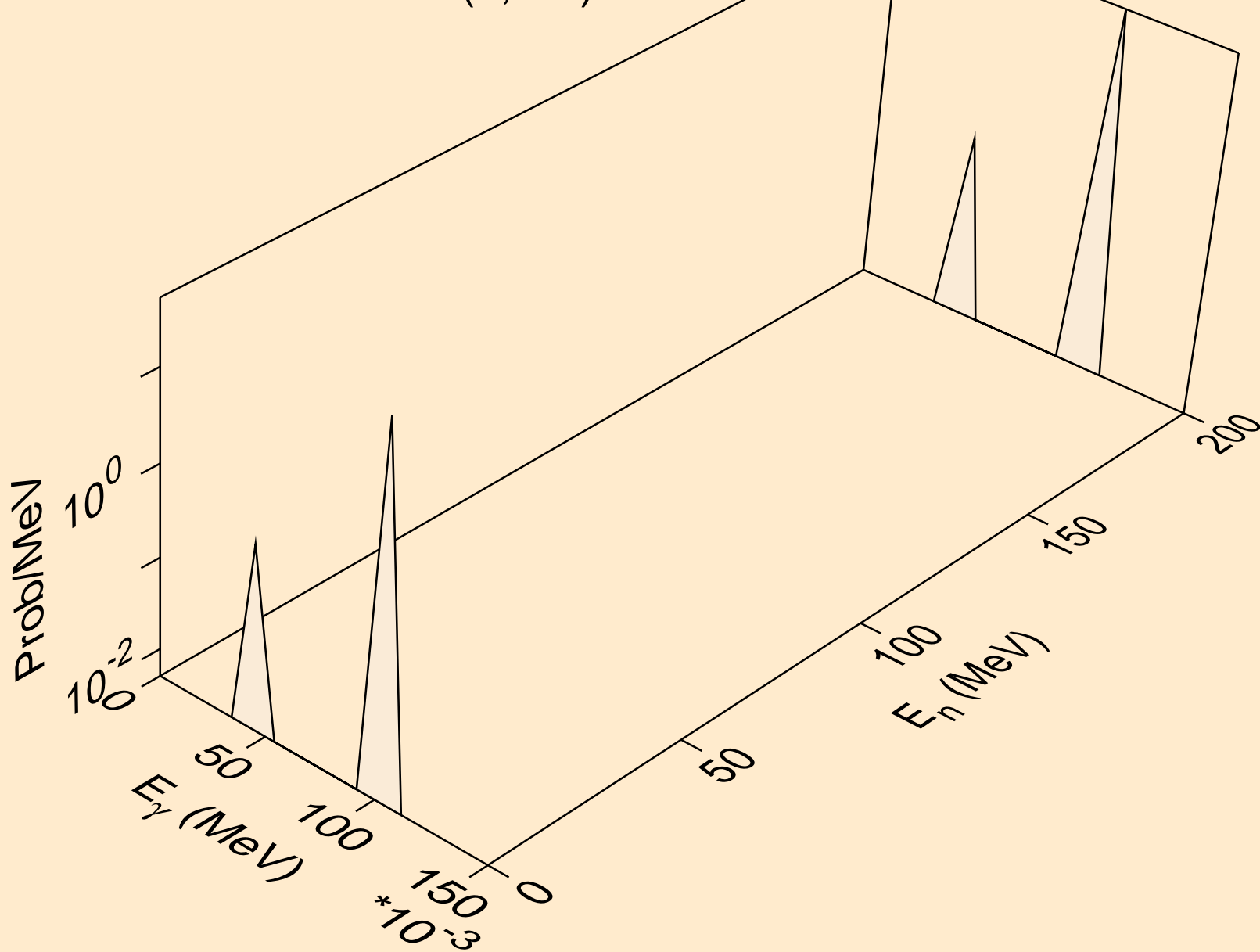

MAT=4331 ACE FILE PRODUCED AT NEA WITH NDEC
Photon emission for (n,a*3)

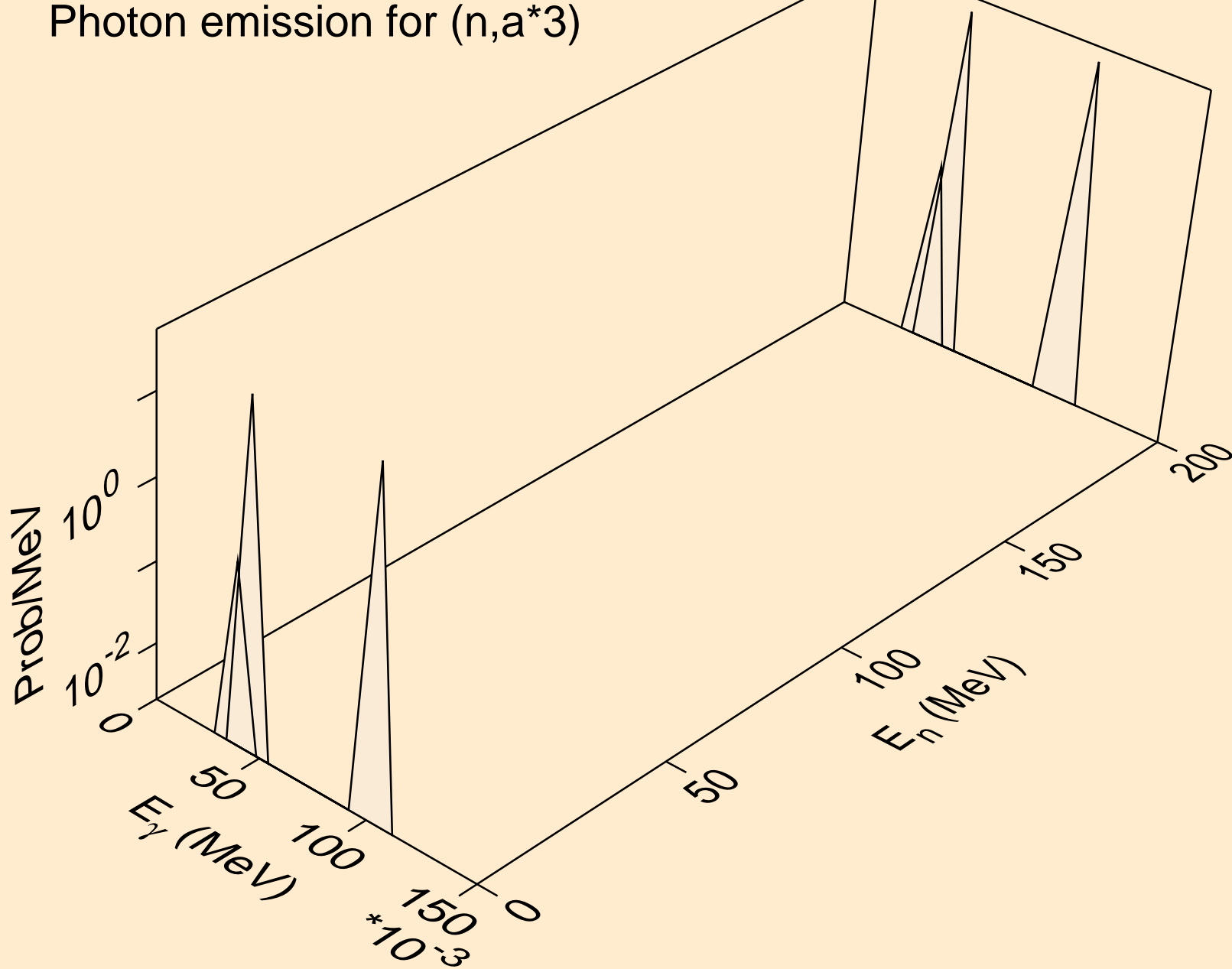

MAT=4331 ACE FILE PRODUCED AT NEA WITH NDEC
Photon emission for (n,a*4)

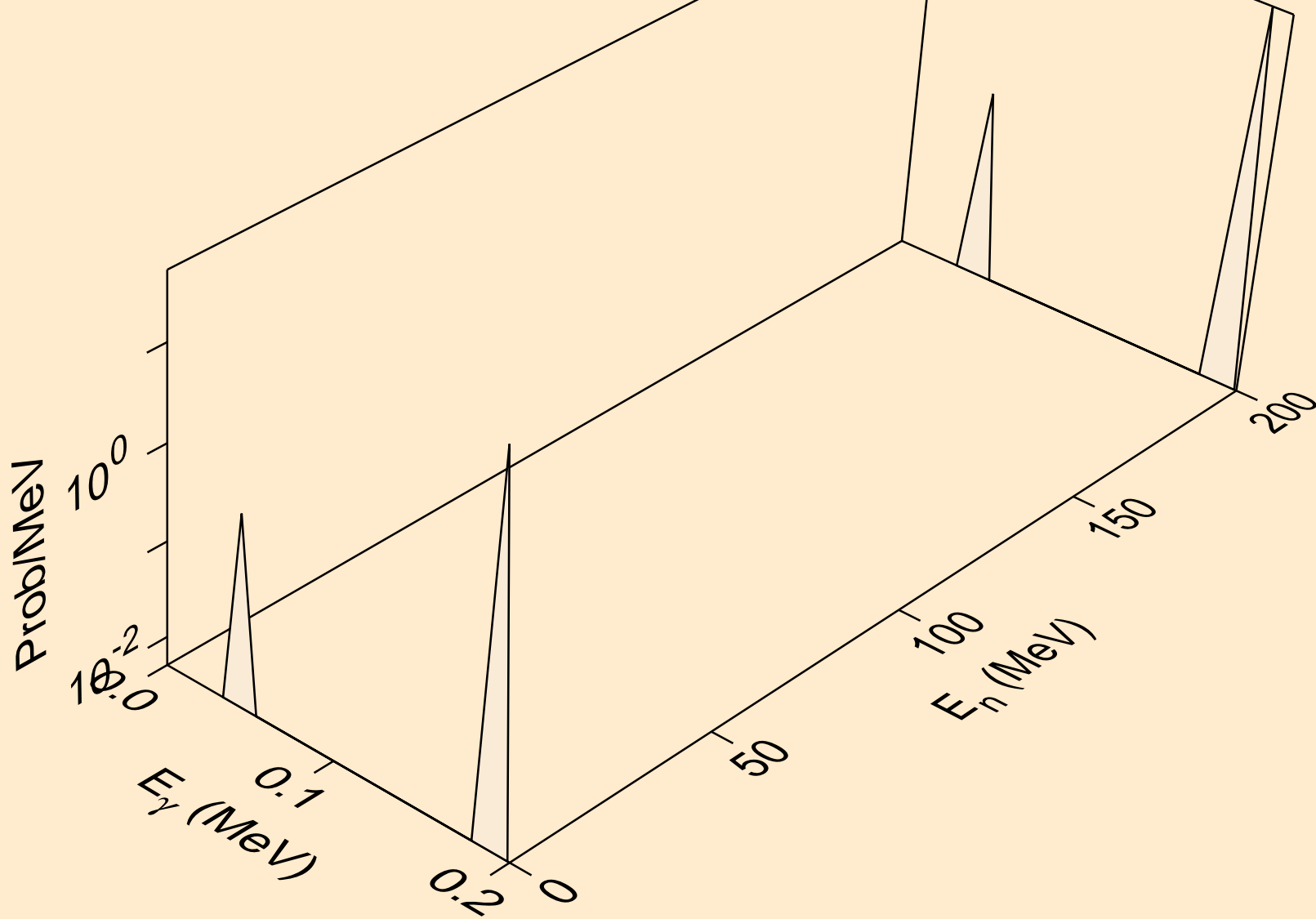

MAT=4331 ACE FILE PRODUCED AT NEA WITH NDEC
Photon emission for (n,a*5)

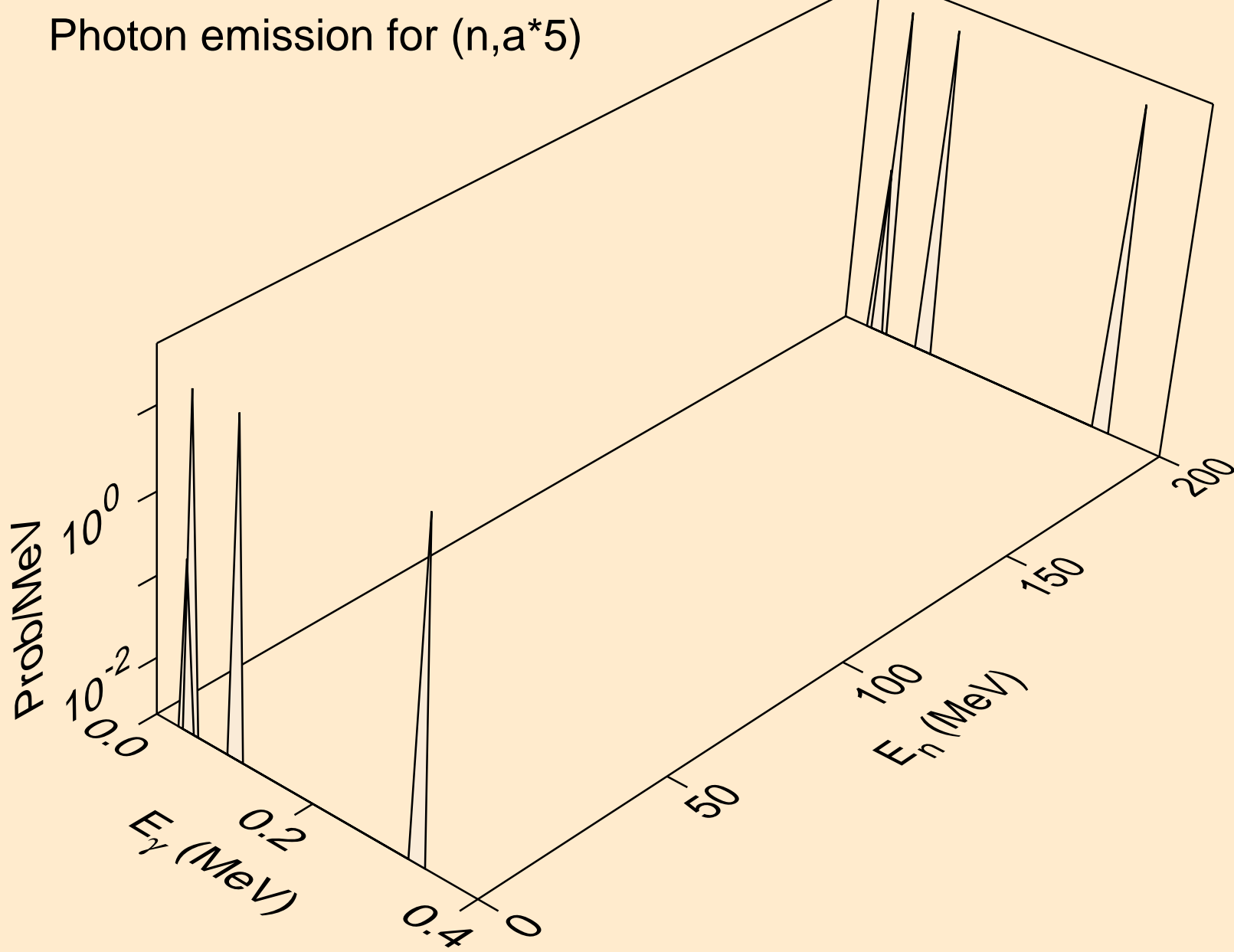

MAT=4331 ACE FILE PRODUCED AT NEA WITH NDEC
Photon emission for (n,a*6)

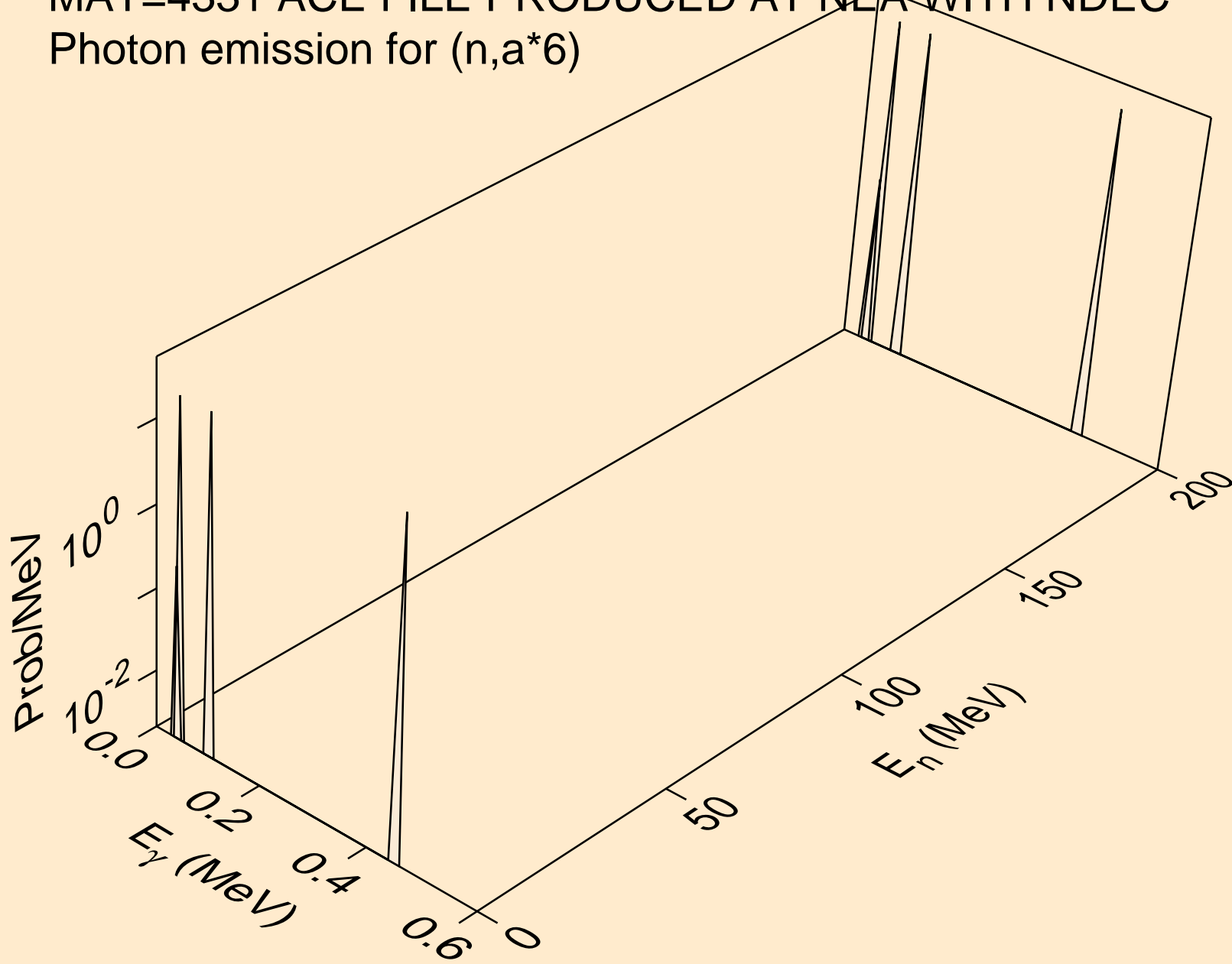

MAT=4331 ACE FILE PRODUCED AT NEA WITH NDEC
Photon emission for (n,a*7)

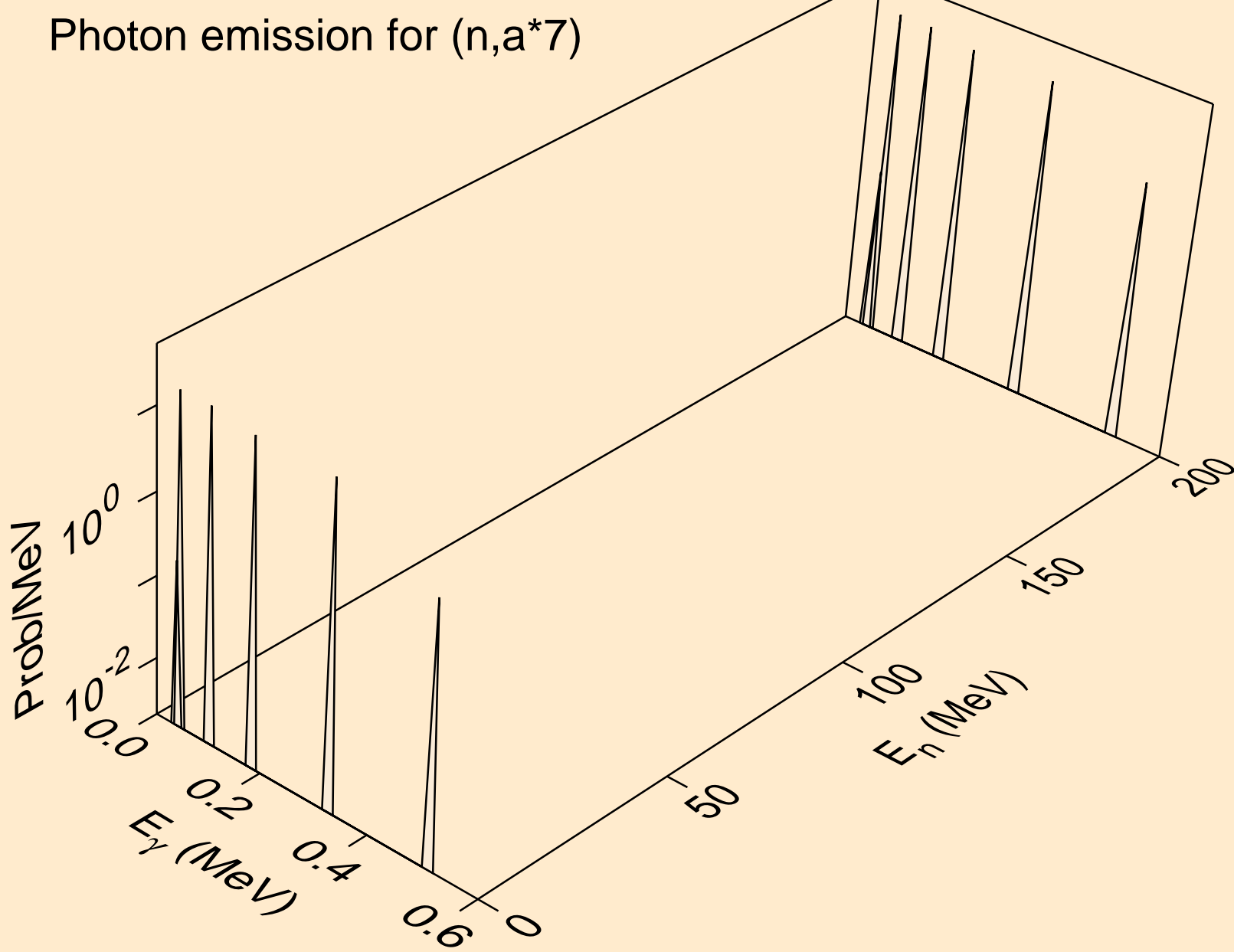

MAT=4331 ACE FILE PRODUCED AT NEA WITH NDEC
Photon emission for (n,a*8)

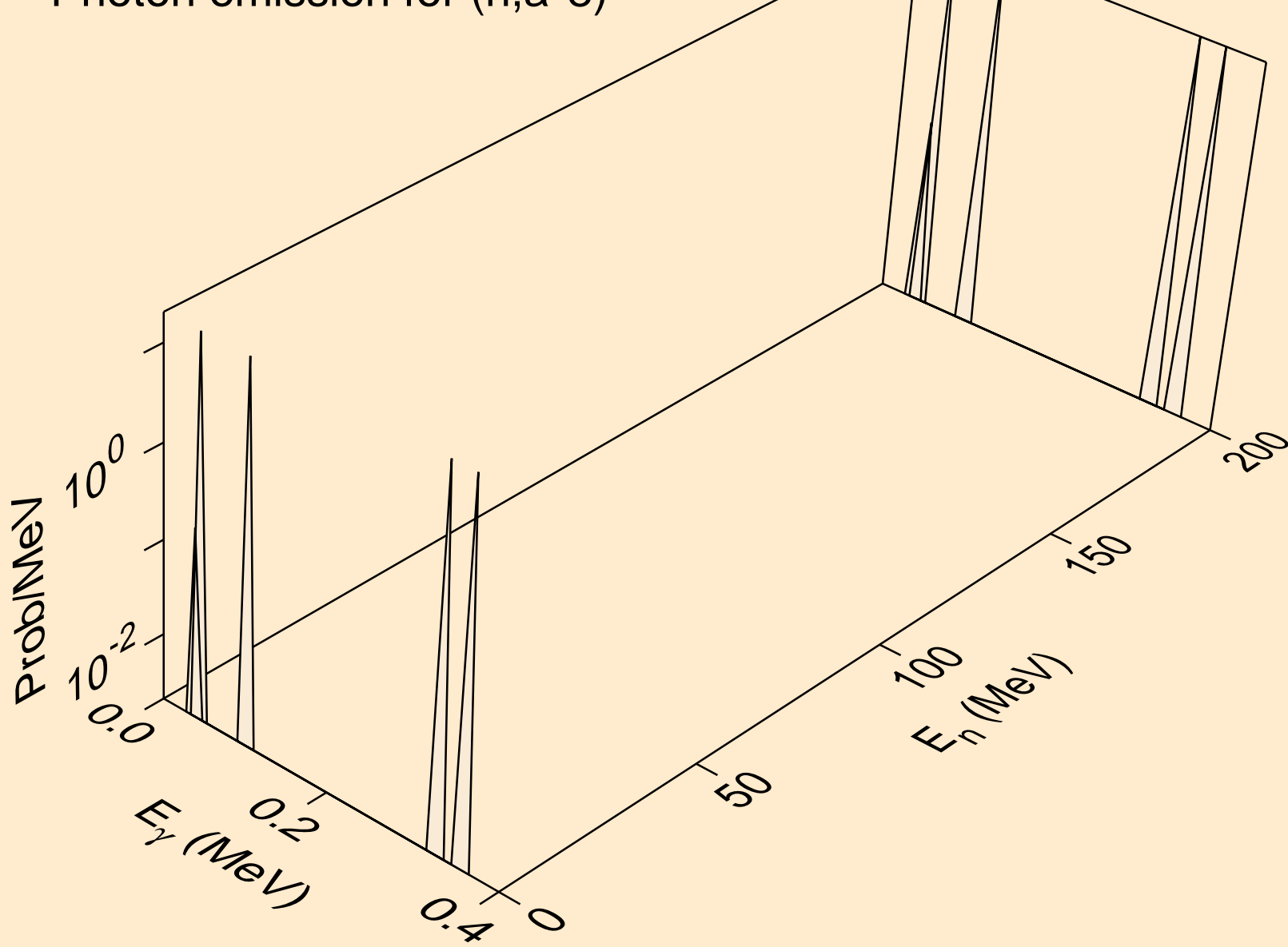

MAT=4331 ACE FILE PRODUCED AT NEA WITH NDEC
Photon emission for (n,a*9)

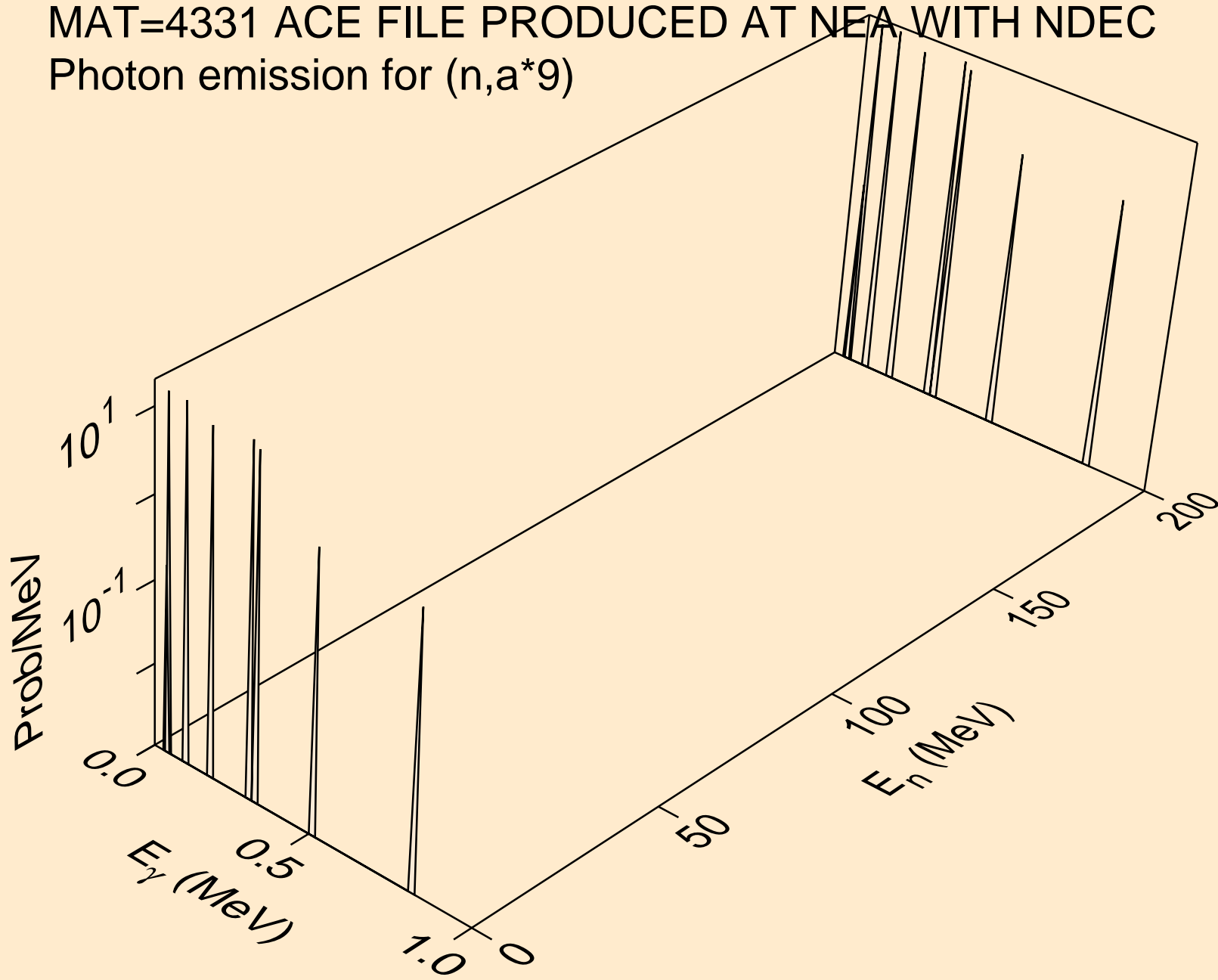

MAT=4331 ACE FILE PRODUCED AT NEA WITH NDEC
Photon emission for (n,a*10)

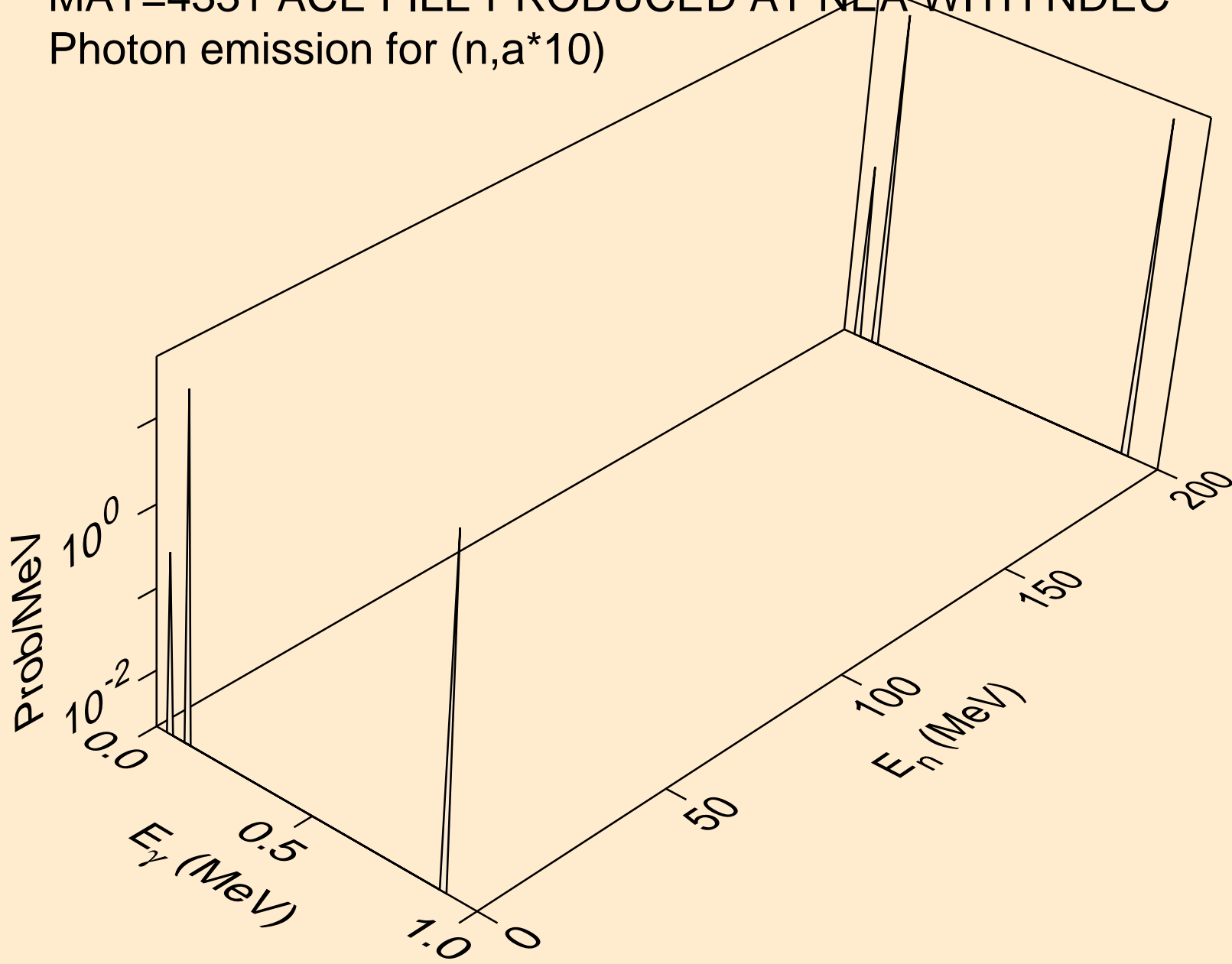

MAT=4331 ACE FILE PRODUCED AT NEA WITH NDEC
Photon emission for (n,a*c)

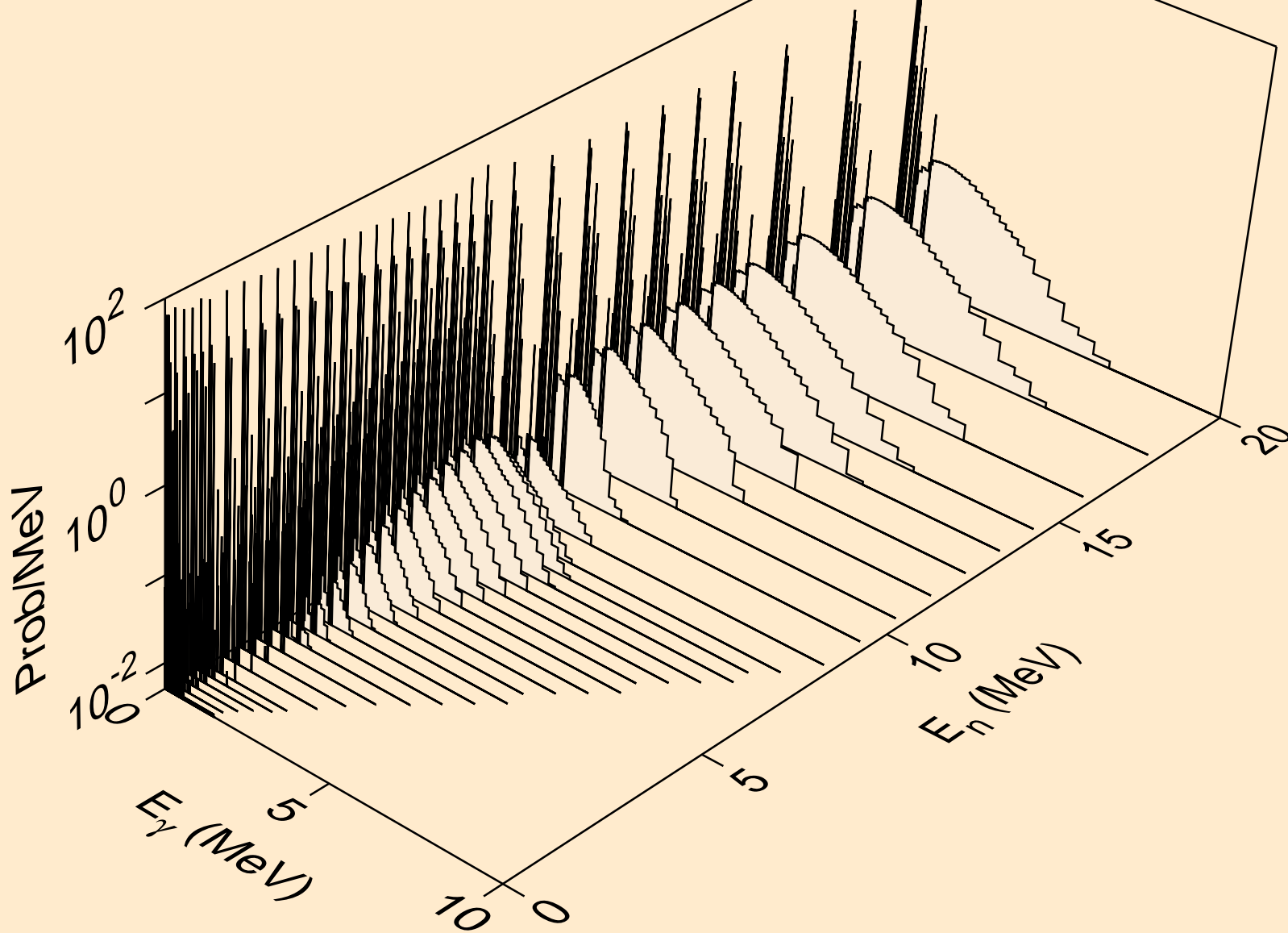

MAT=4331 ACE FILE PRODUCED AT NEA WITH NDEC
thermal capture photon spectrum

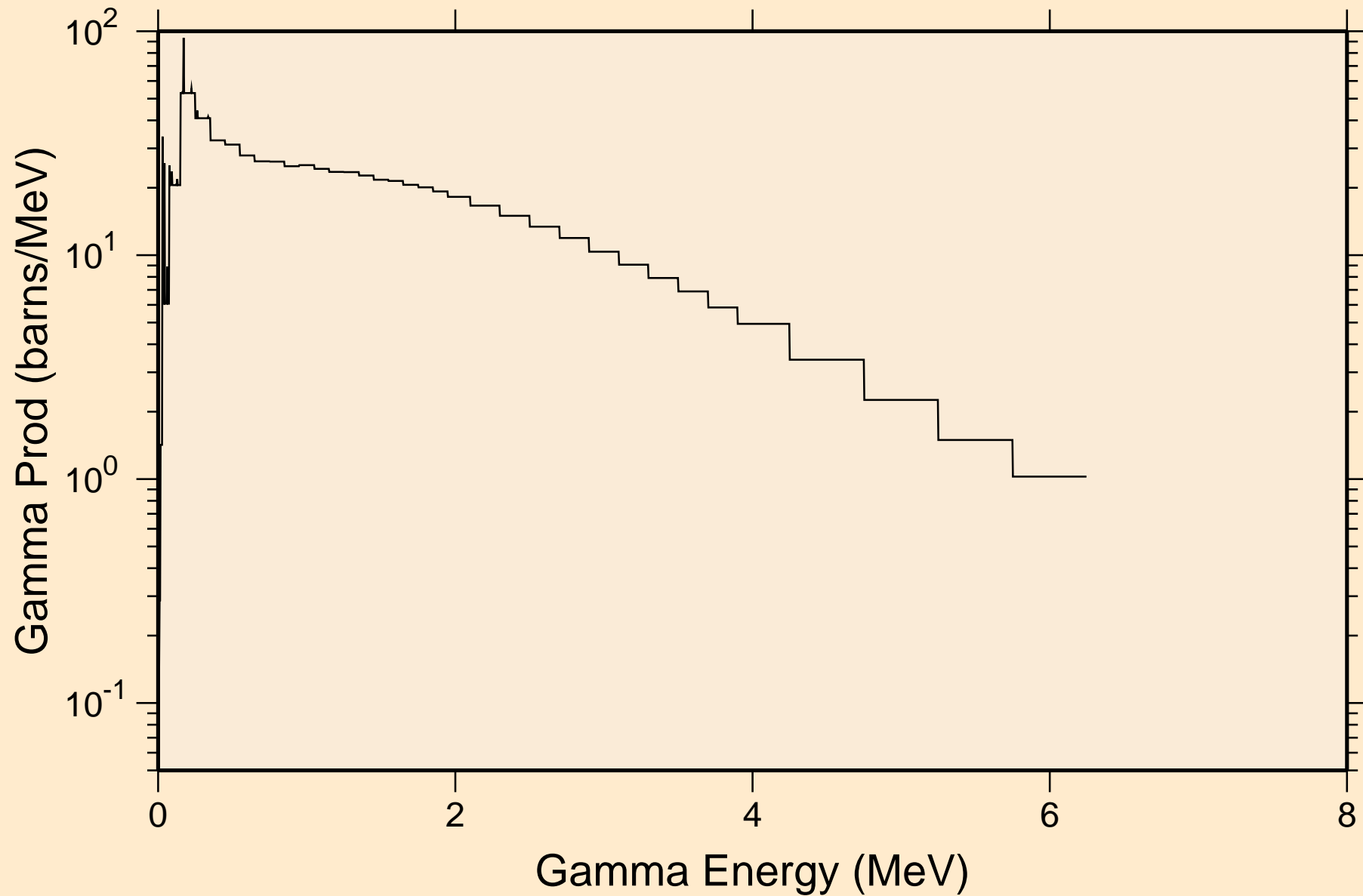

MAT=4331 ACE FILE PRODUCED AT NEA WITH NDEC
14 MeV photon spectrum

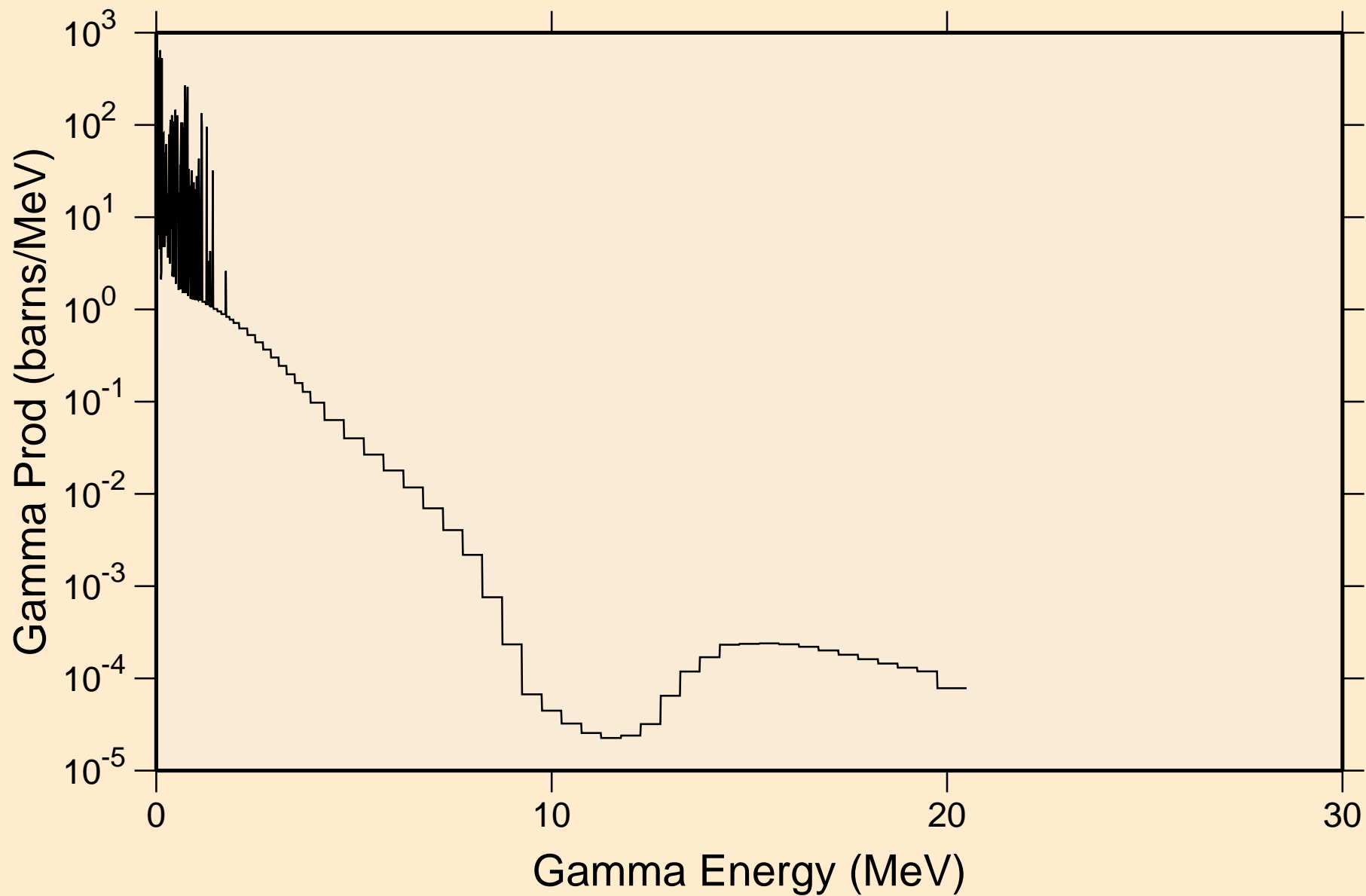

MAT=4331 ACE FILE PRODUCED AT NEA WITH NDEC
Particle heating contributions

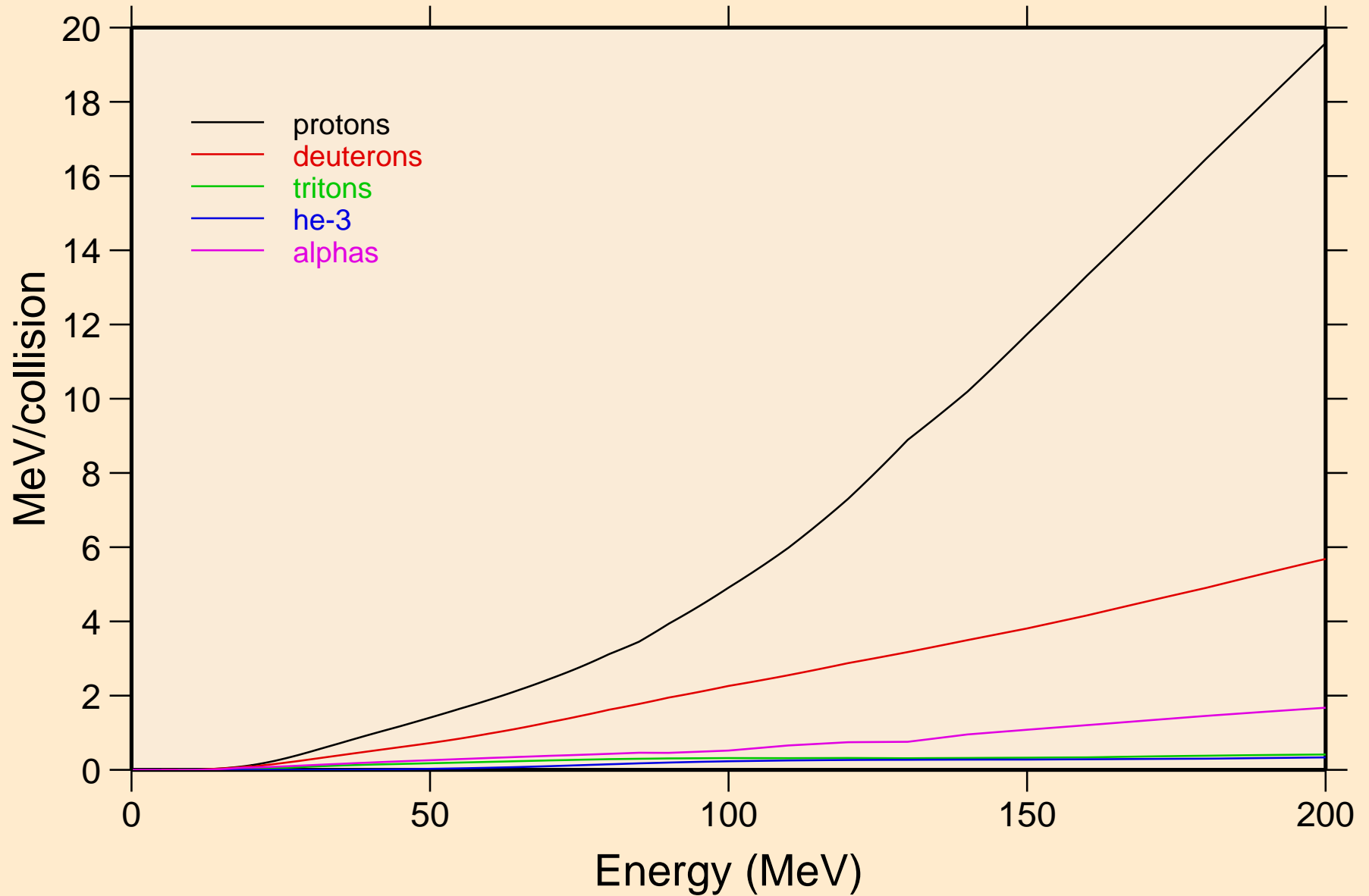

MAT=4331 ACE FILE PRODUCED AT NEA WITH NDEC
Recoil Heating

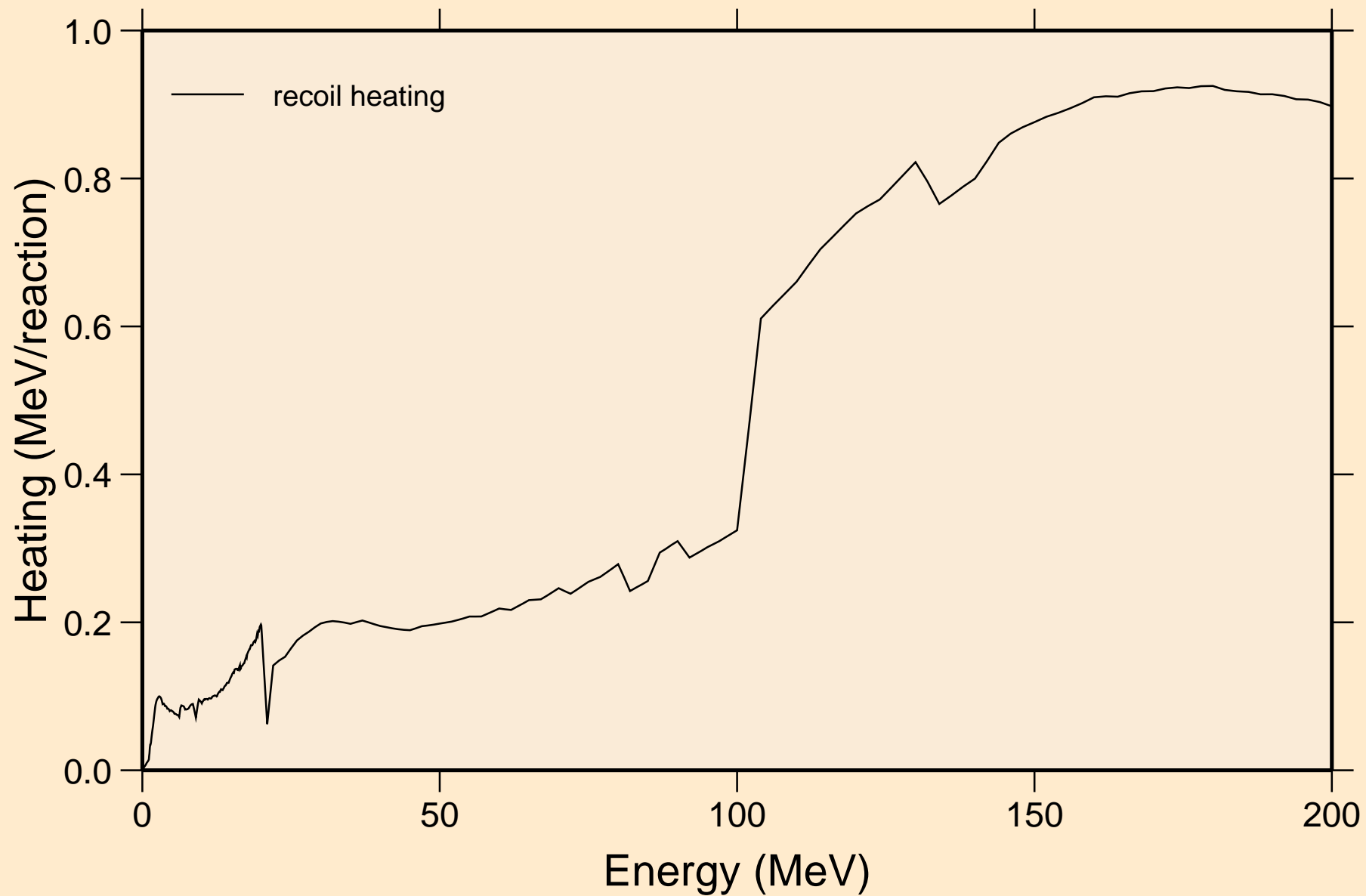

MAT=4331 ACE FILE PRODUCED AT NEA WITH NDEC
Particle production cross sections

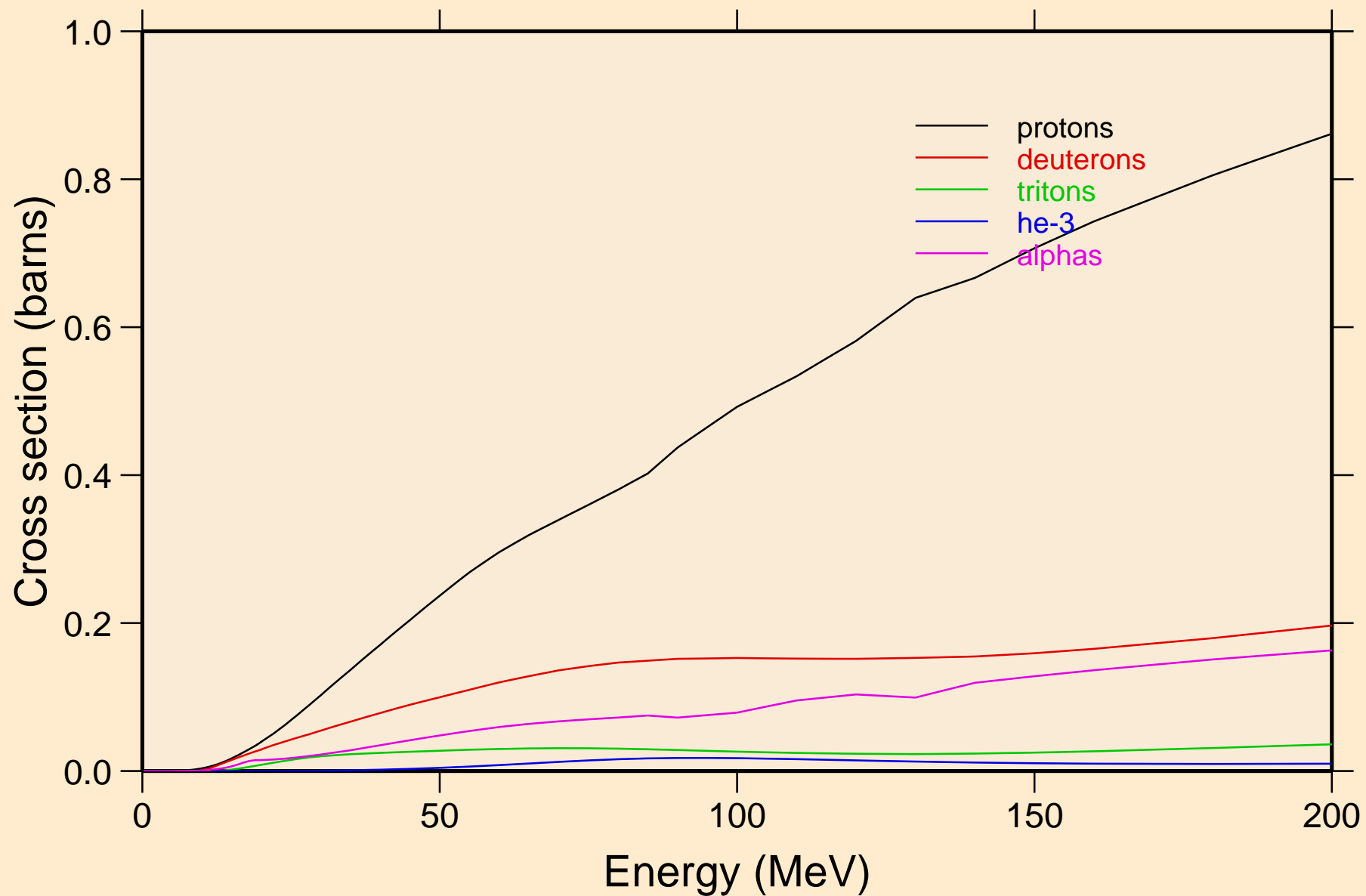

MAT=4331 ACE FILE PRODUCED AT NEA WITH NDEC
protons from (n,x)

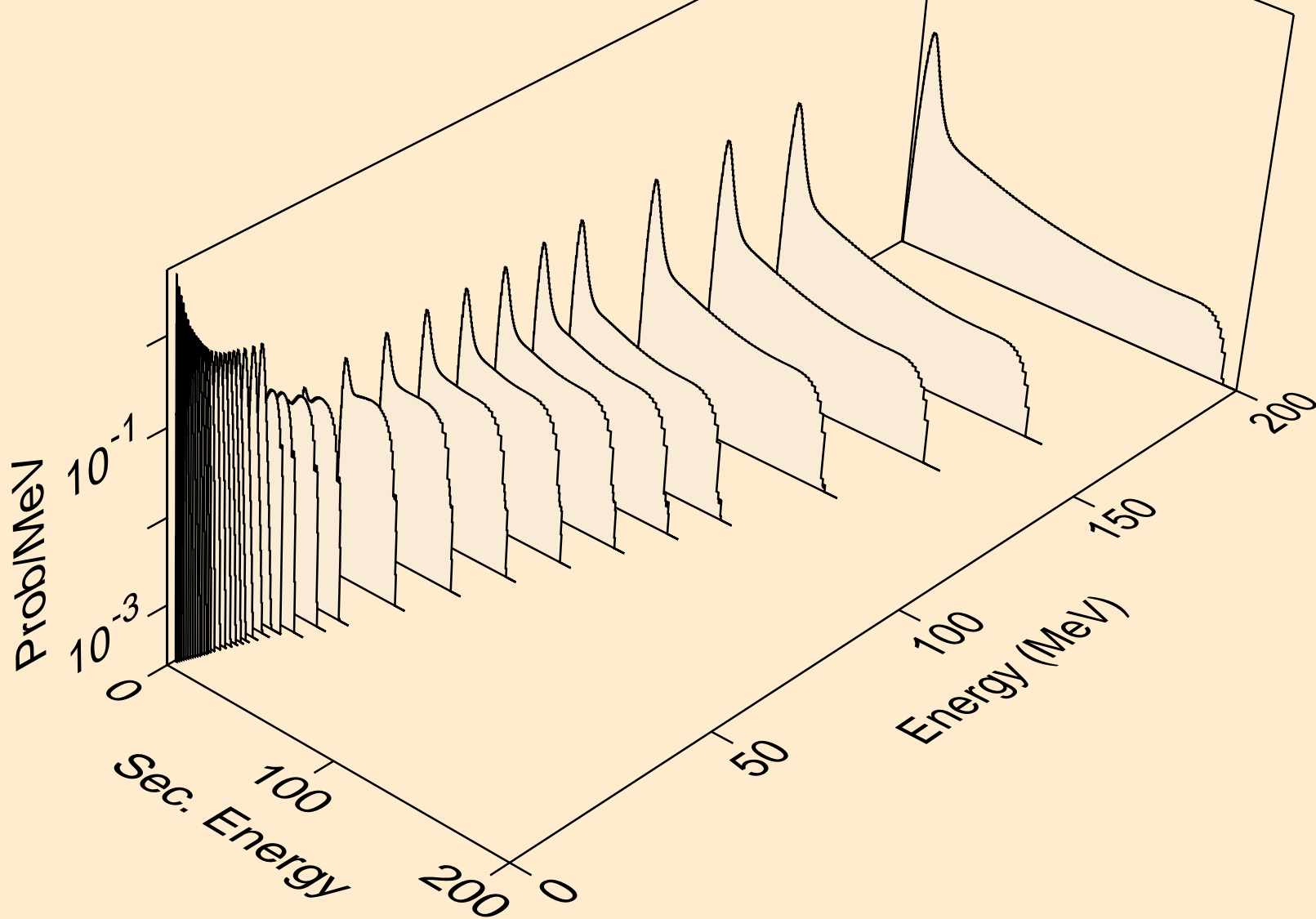

MAT=4331 ACE FILE PRODUCED AT NEA WITH NDEC
protons from (n,n*)p

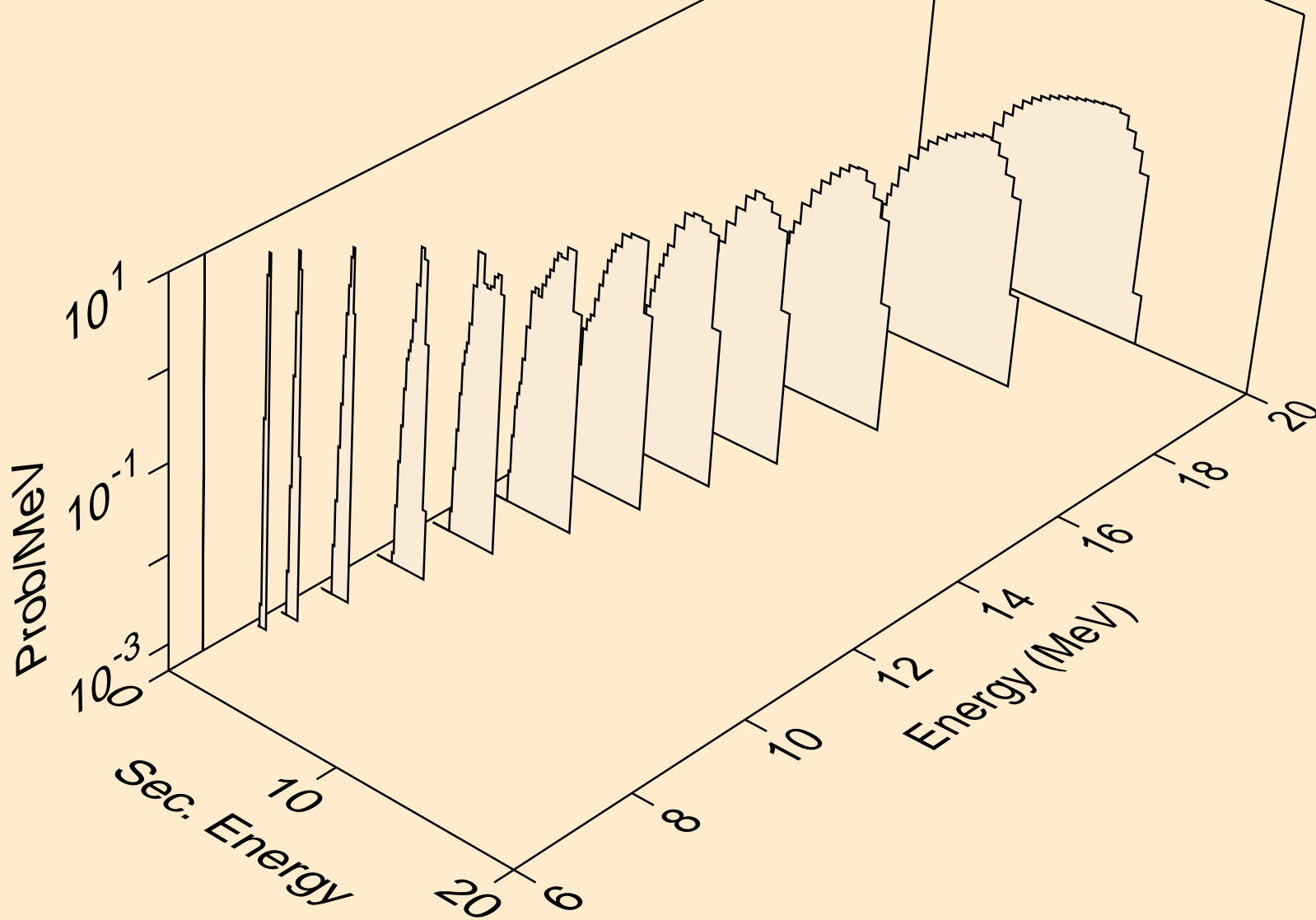

MAT=4331 ACE FILE PRODUCED AT NEA WITH NDEC
protons from (n,2np)

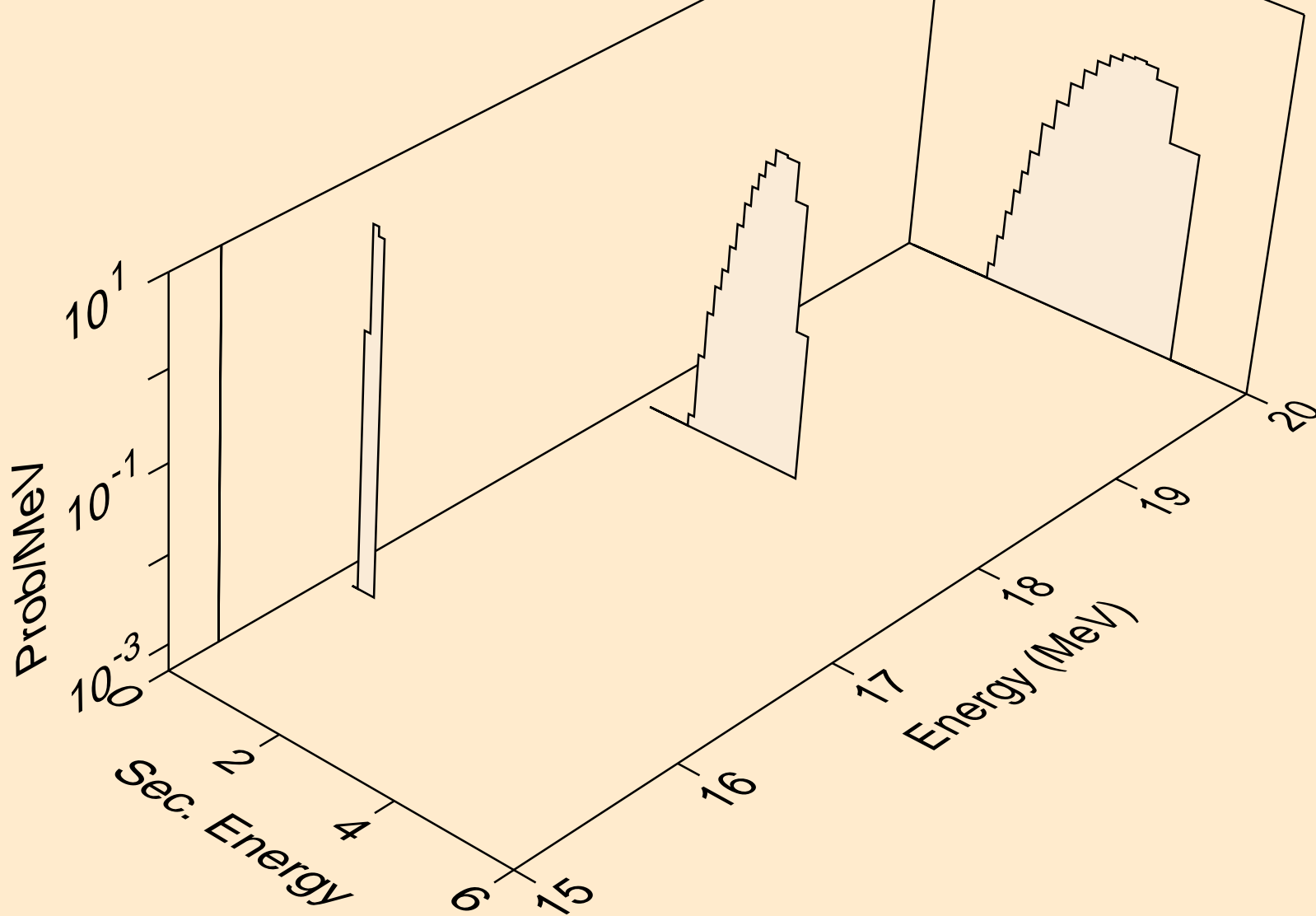

MAT=4331 ACE FILE PRODUCED AT NEA WITH NDEC
protons from (n,2p)

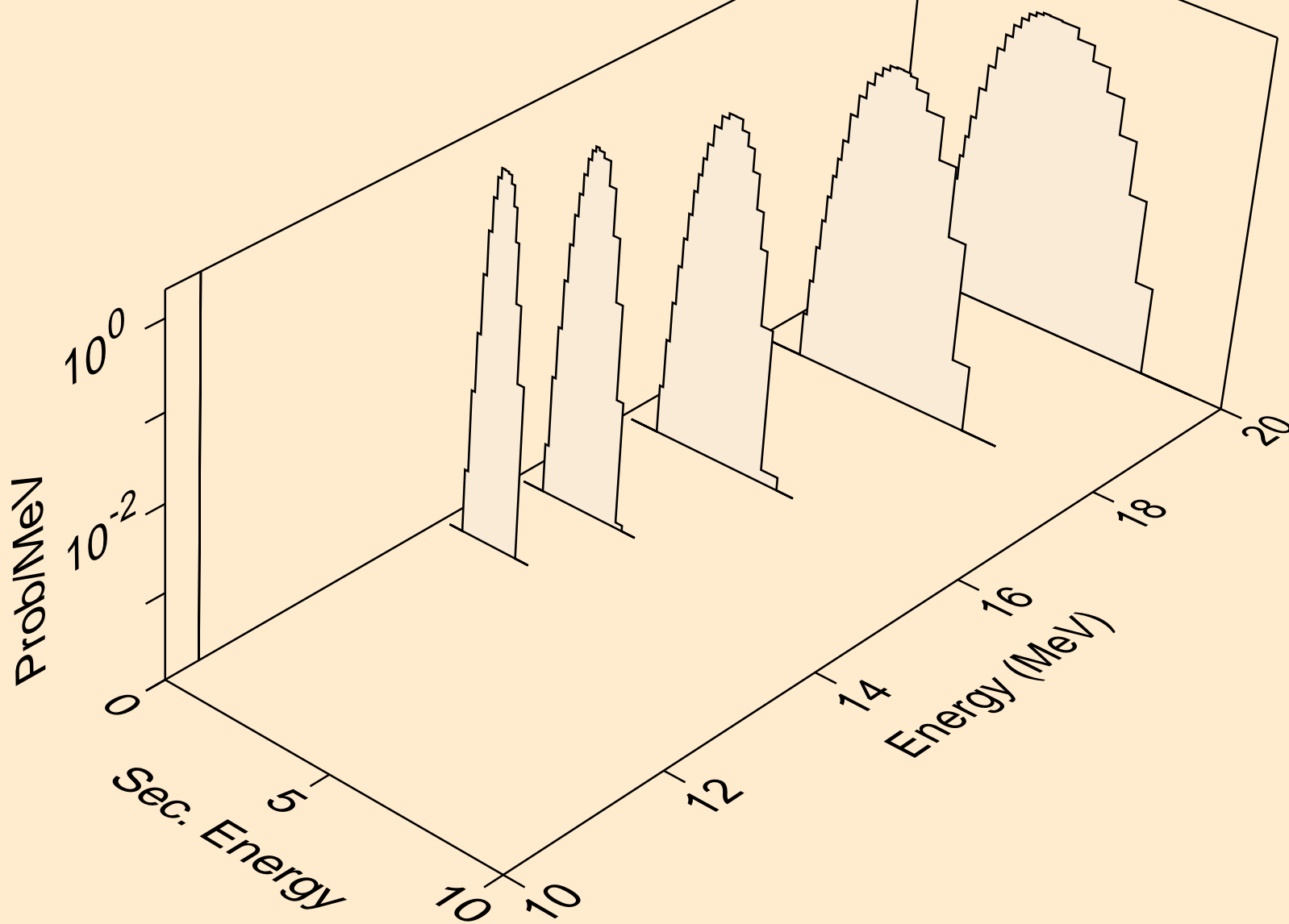

MAT=4331 ACE FILE PRODUCED AT NEA WITH NDEC
protons from (n,pa)

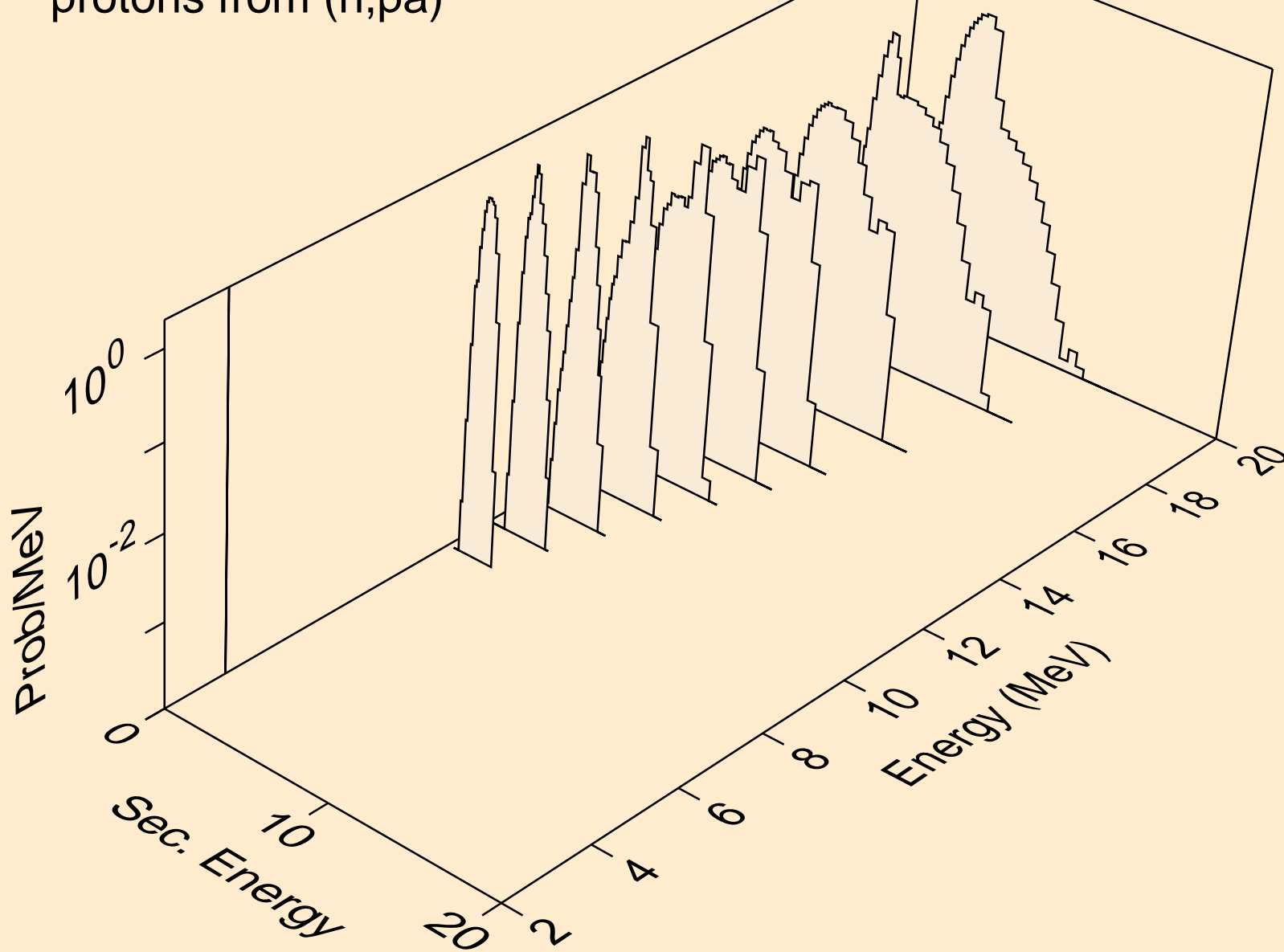

MAT=4331 ACE FILE PRODUCED AT NEA WITH NDEC
angular distribution for (n,p*0) proton

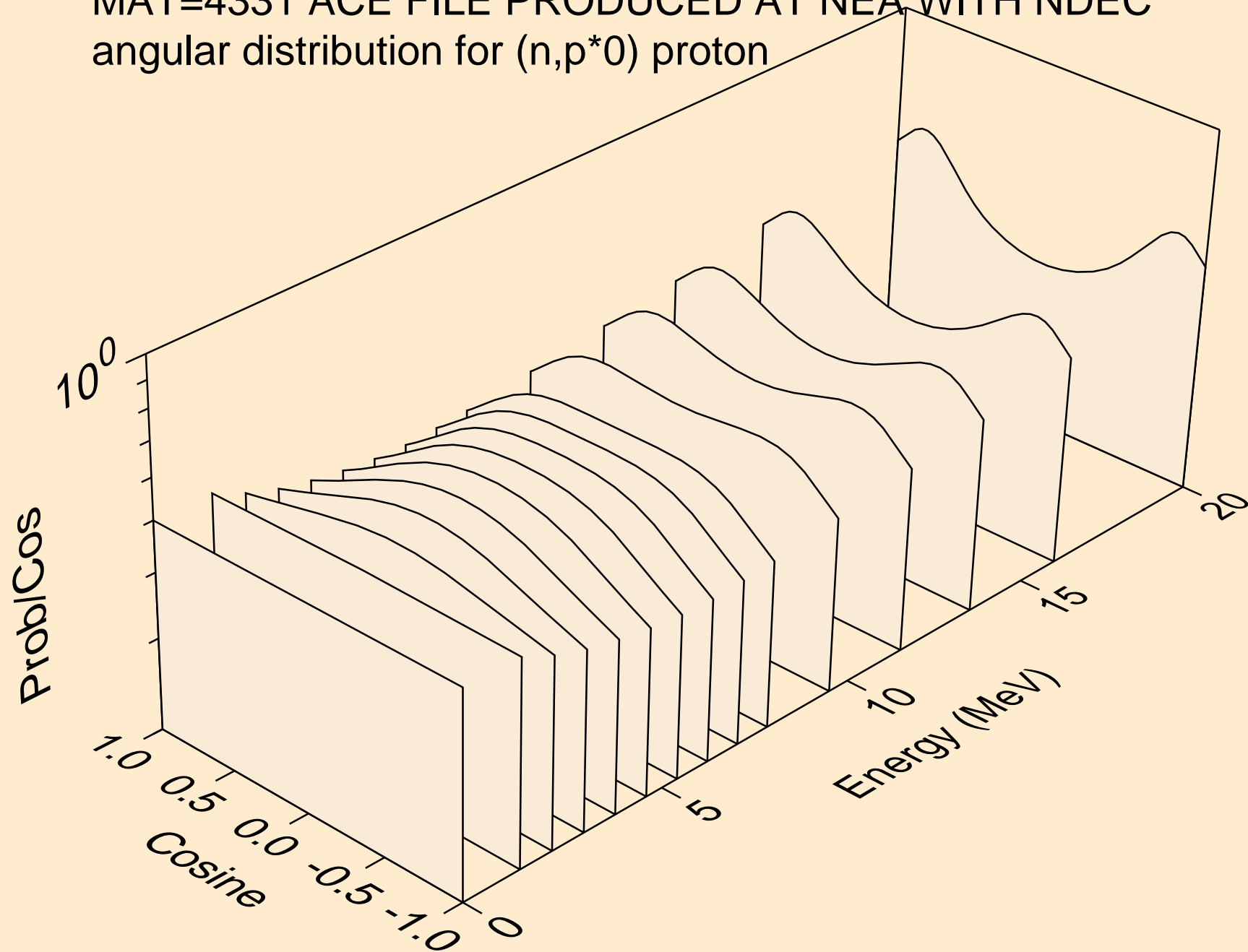

MAT=4331 ACE FILE PRODUCED AT NEA WITH NDEC
angular distribution for (n,p*1) proton

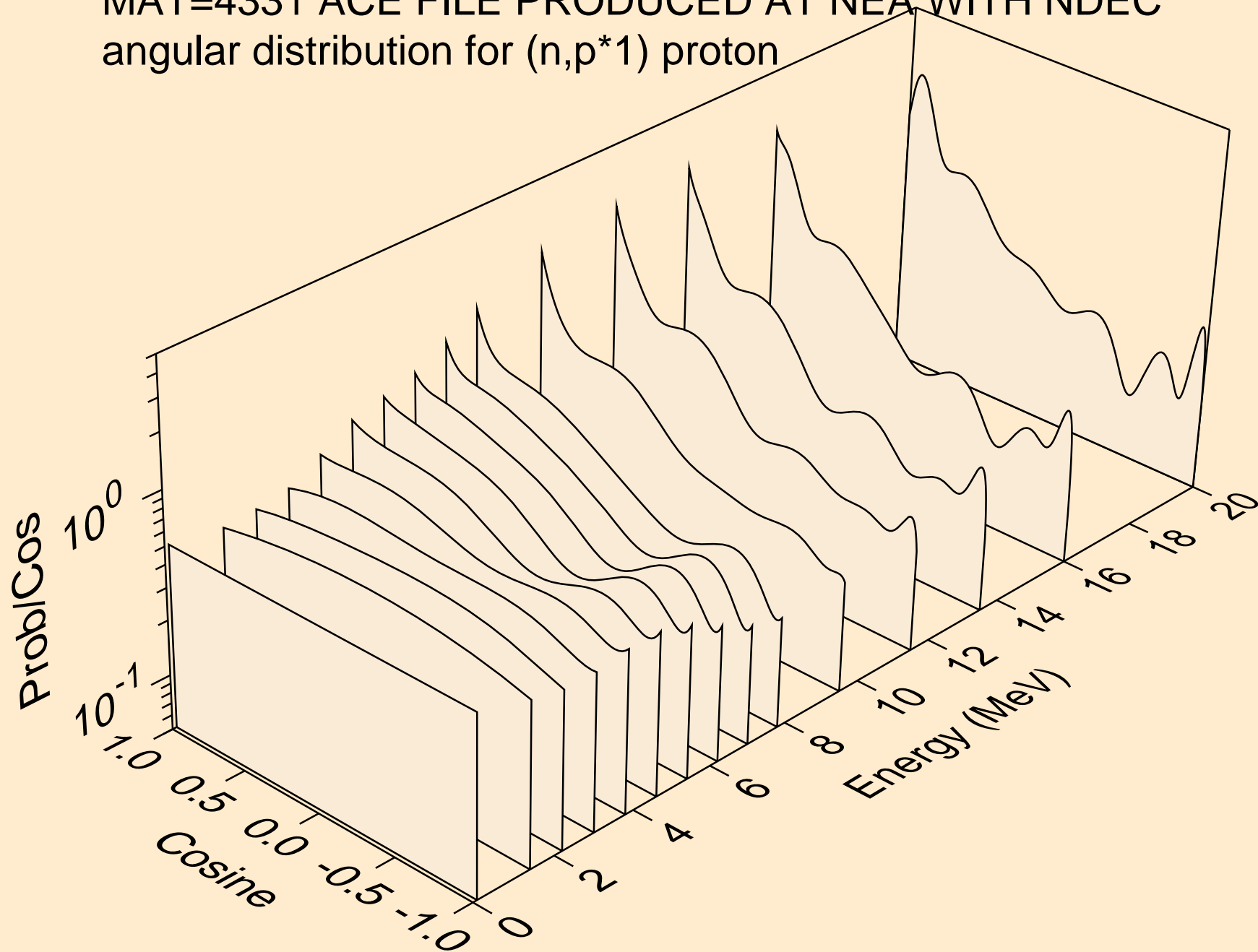

MAT=4331 ACE FILE PRODUCED AT NEA WITH NDEC
angular distribution for (n,p*2) proton

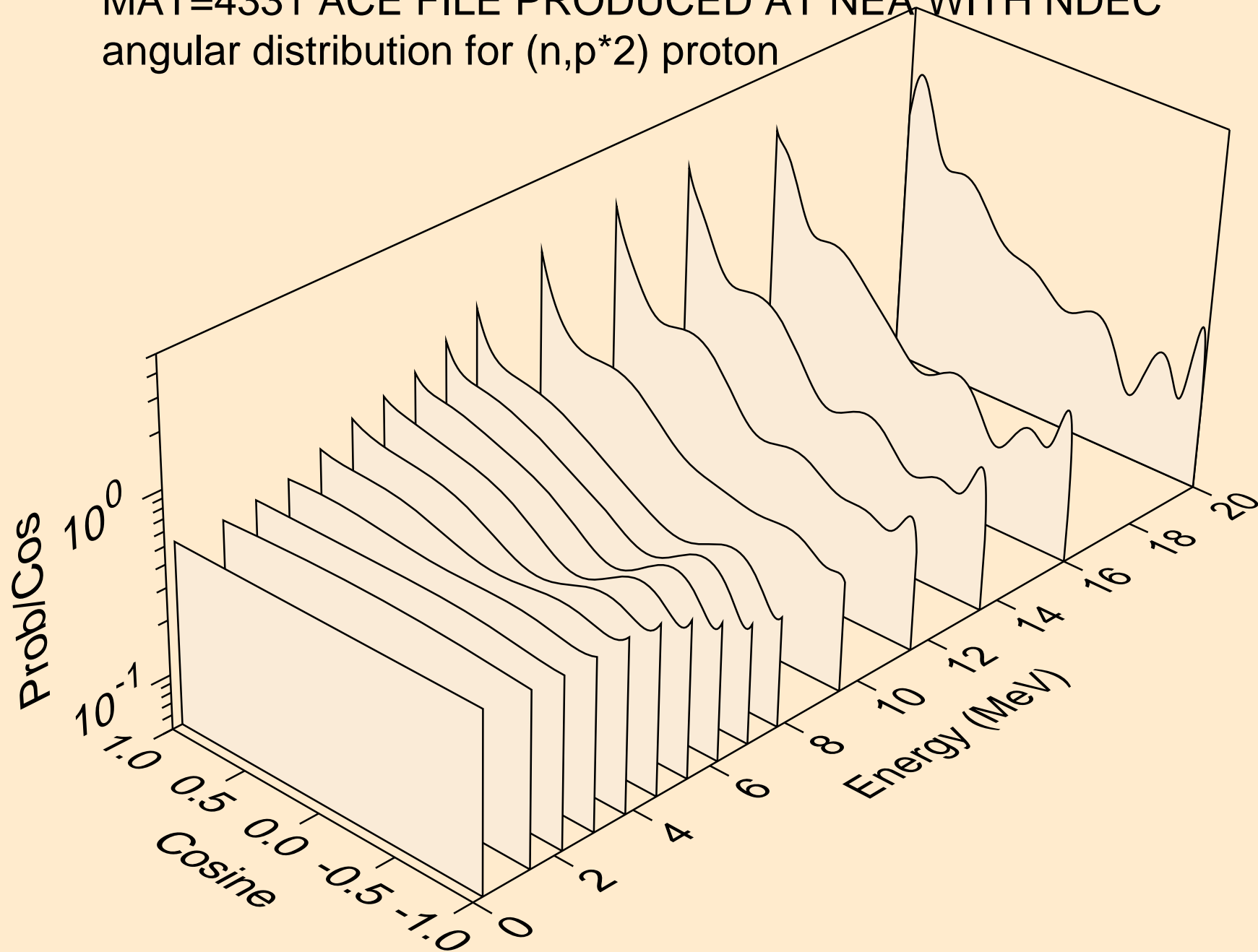

MAT=4331 ACE FILE PRODUCED AT NEA WITH NDEC
angular distribution for (n,p*3) proton

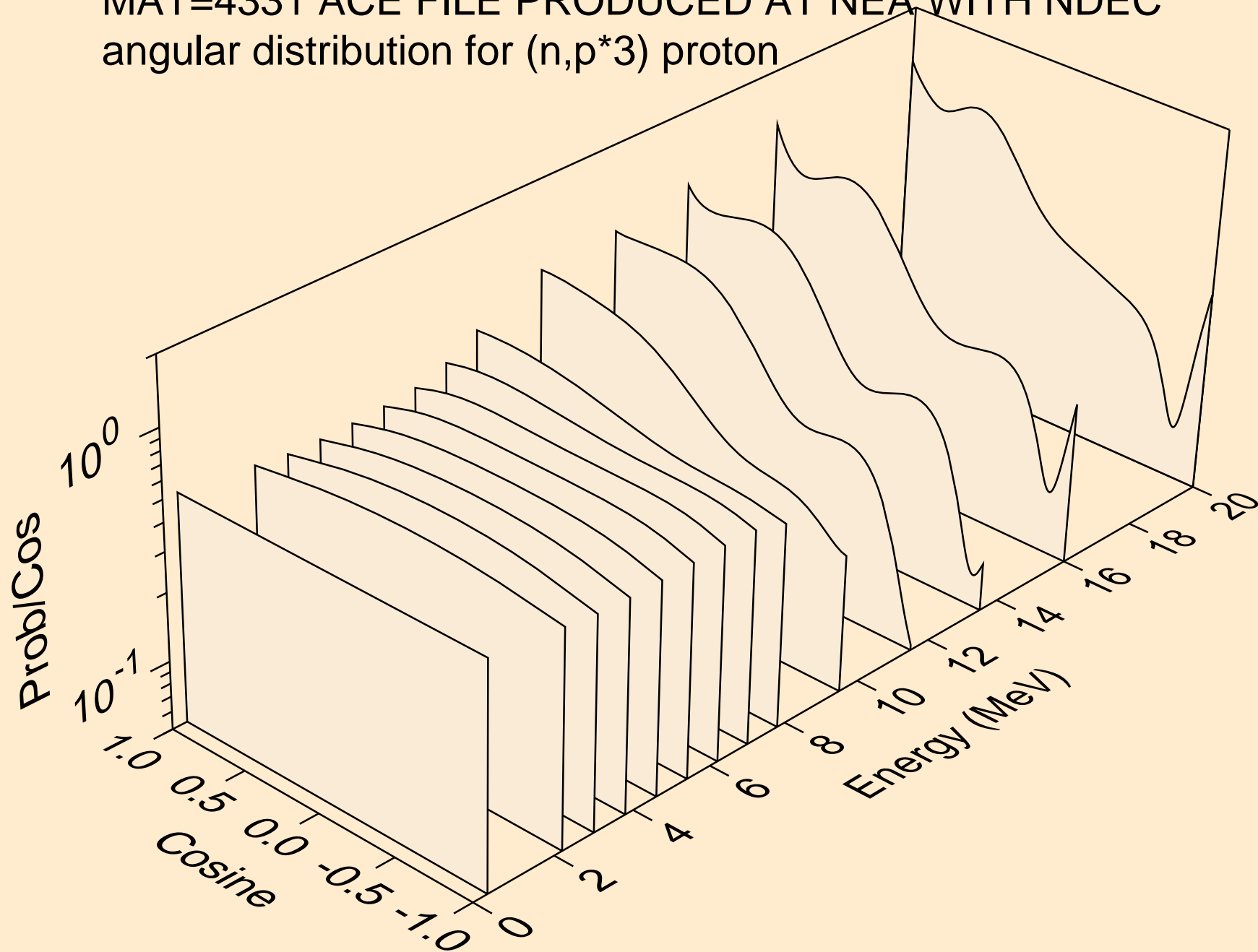

MAT=4331 ACE FILE PRODUCED AT NEA WITH NDEC
angular distribution for (n,p*4) proton

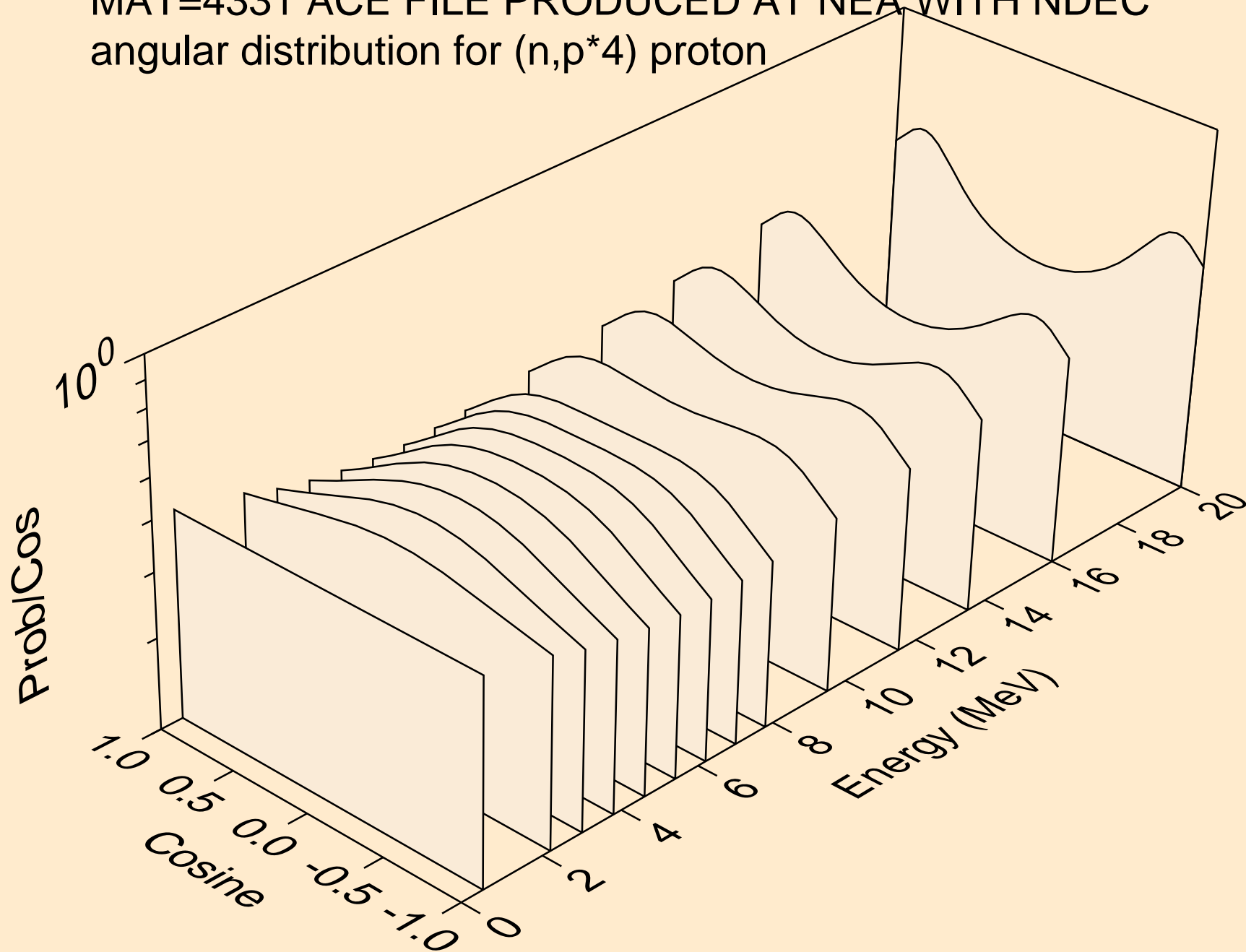

MAT=4331 ACE FILE PRODUCED AT NEA WITH NDEC
angular distribution for (n,p*5) proton

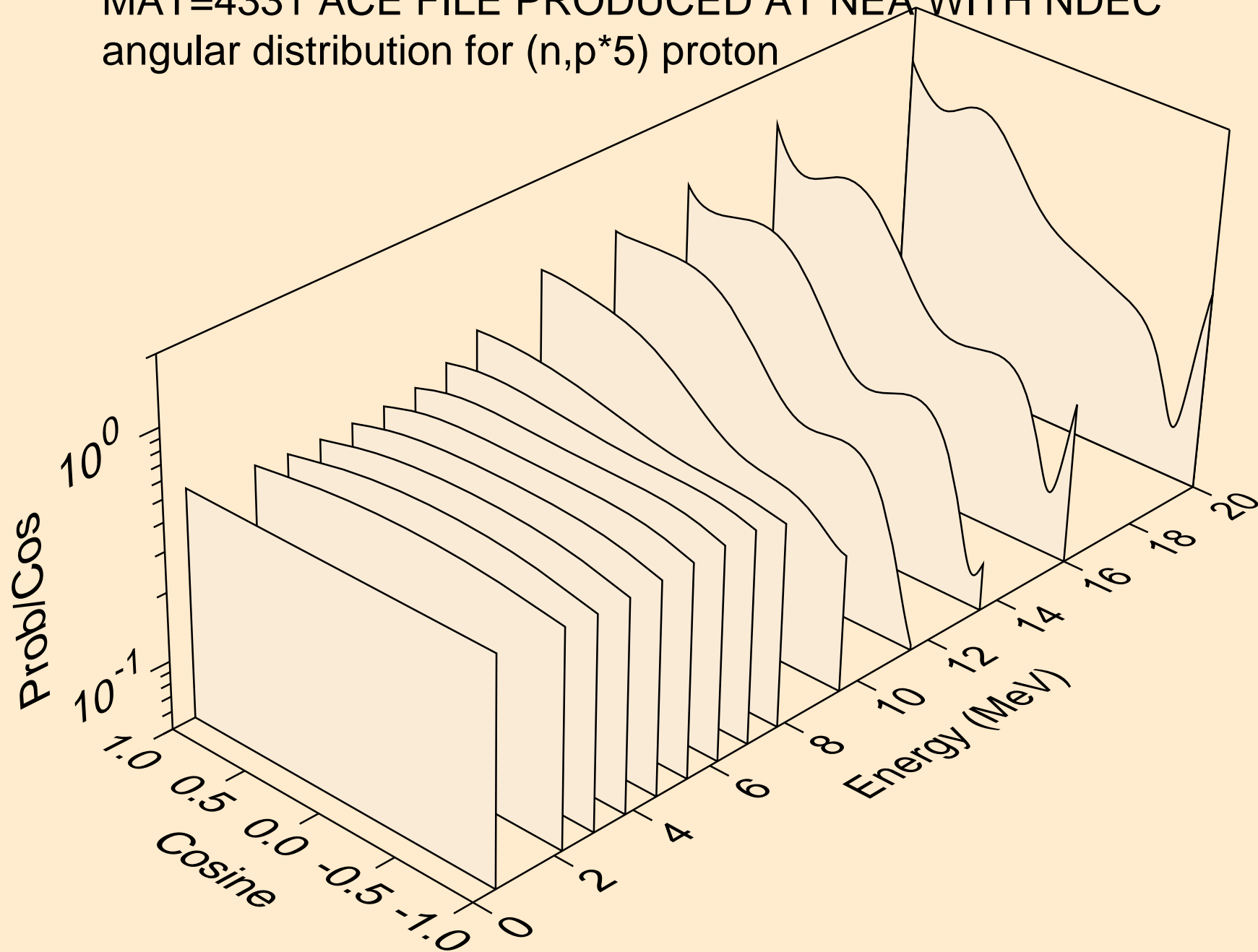

MAT=4331 ACE FILE PRODUCED AT NEA WITH NDEC
angular distribution for (n,p*6) proton

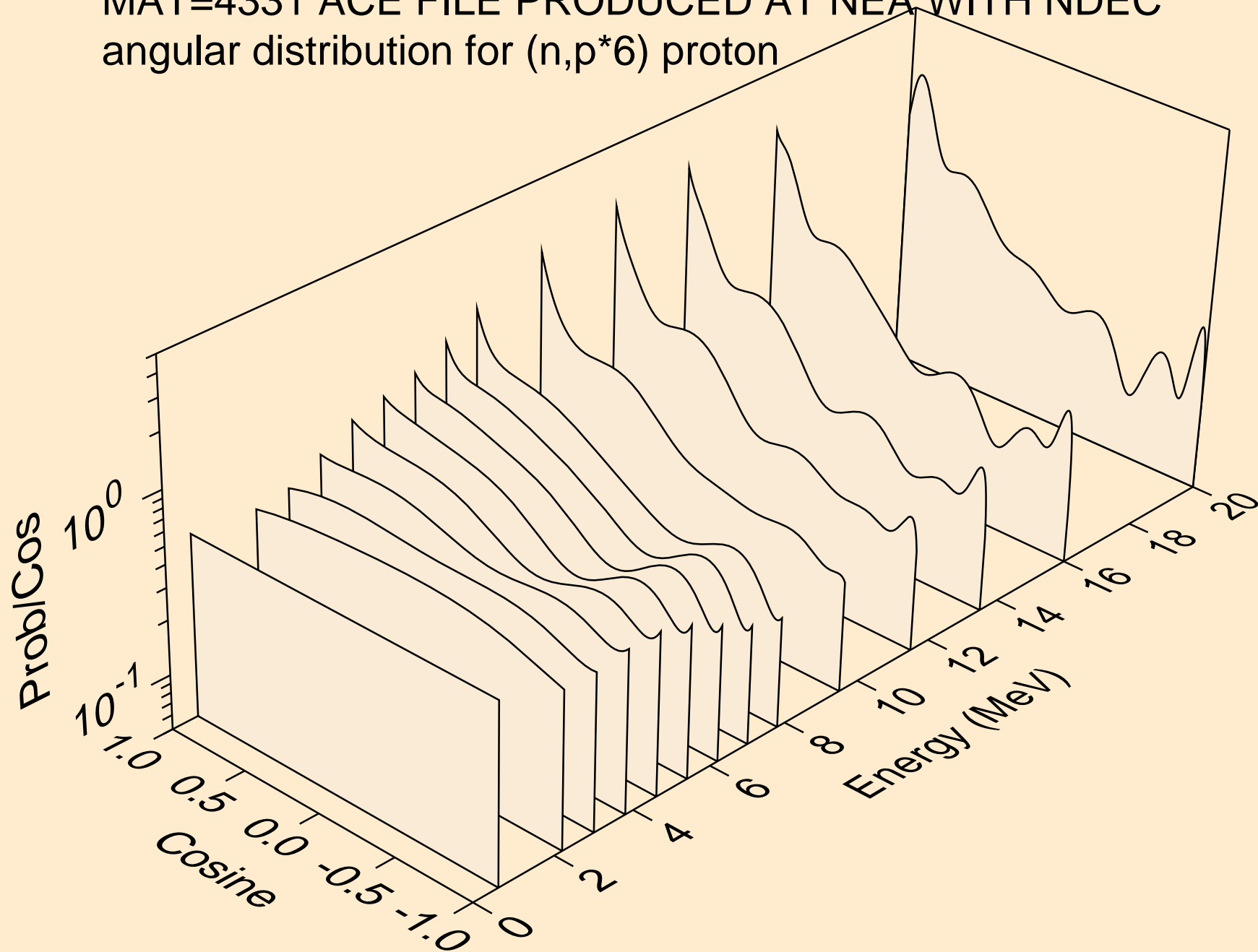

MAT=4331 ACE FILE PRODUCED AT NEA WITH NDEC
angular distribution for (n,p*7) proton

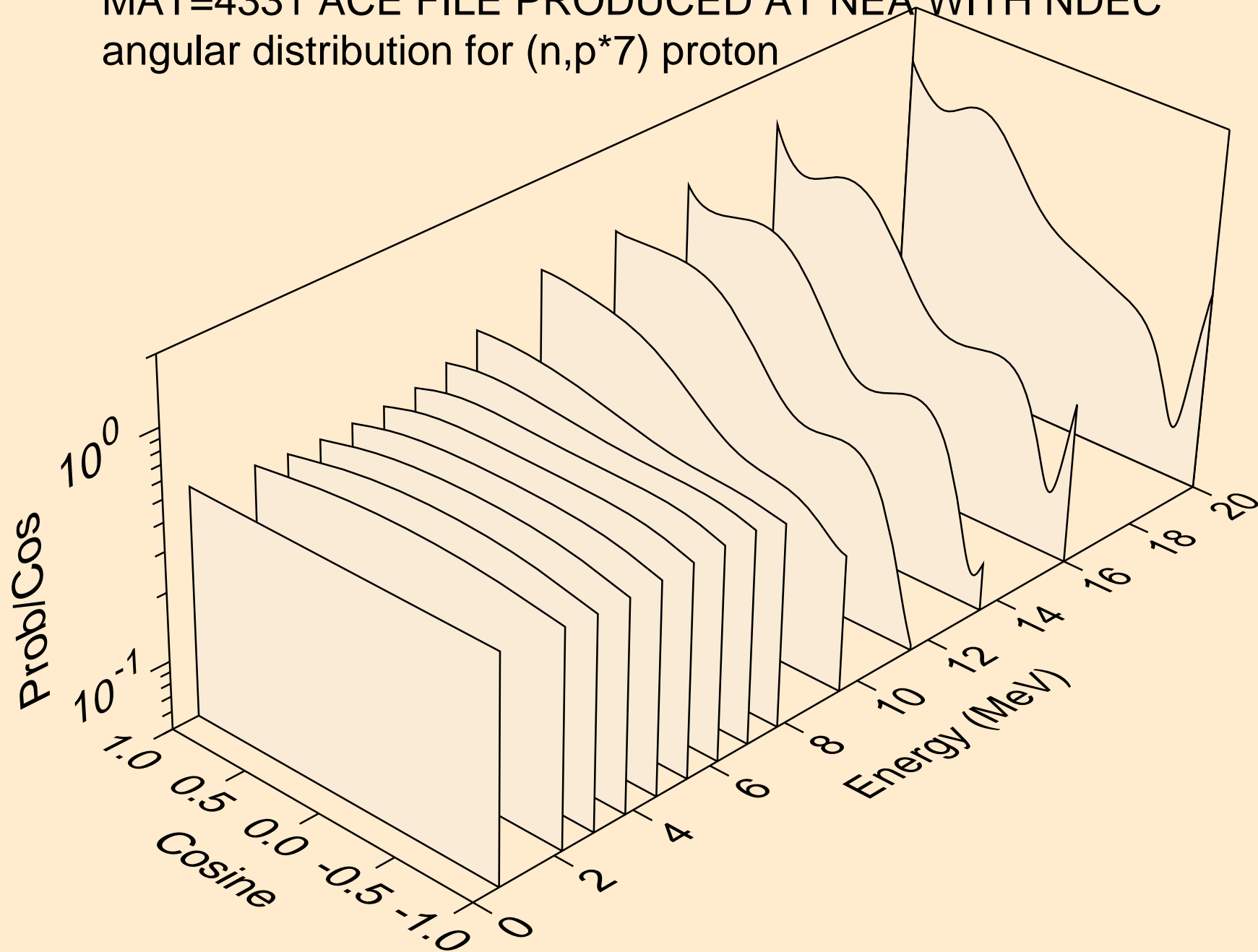

MAT=4331 ACE FILE PRODUCED AT NEA WITH NDEC
angular distribution for (n,p*8) proton

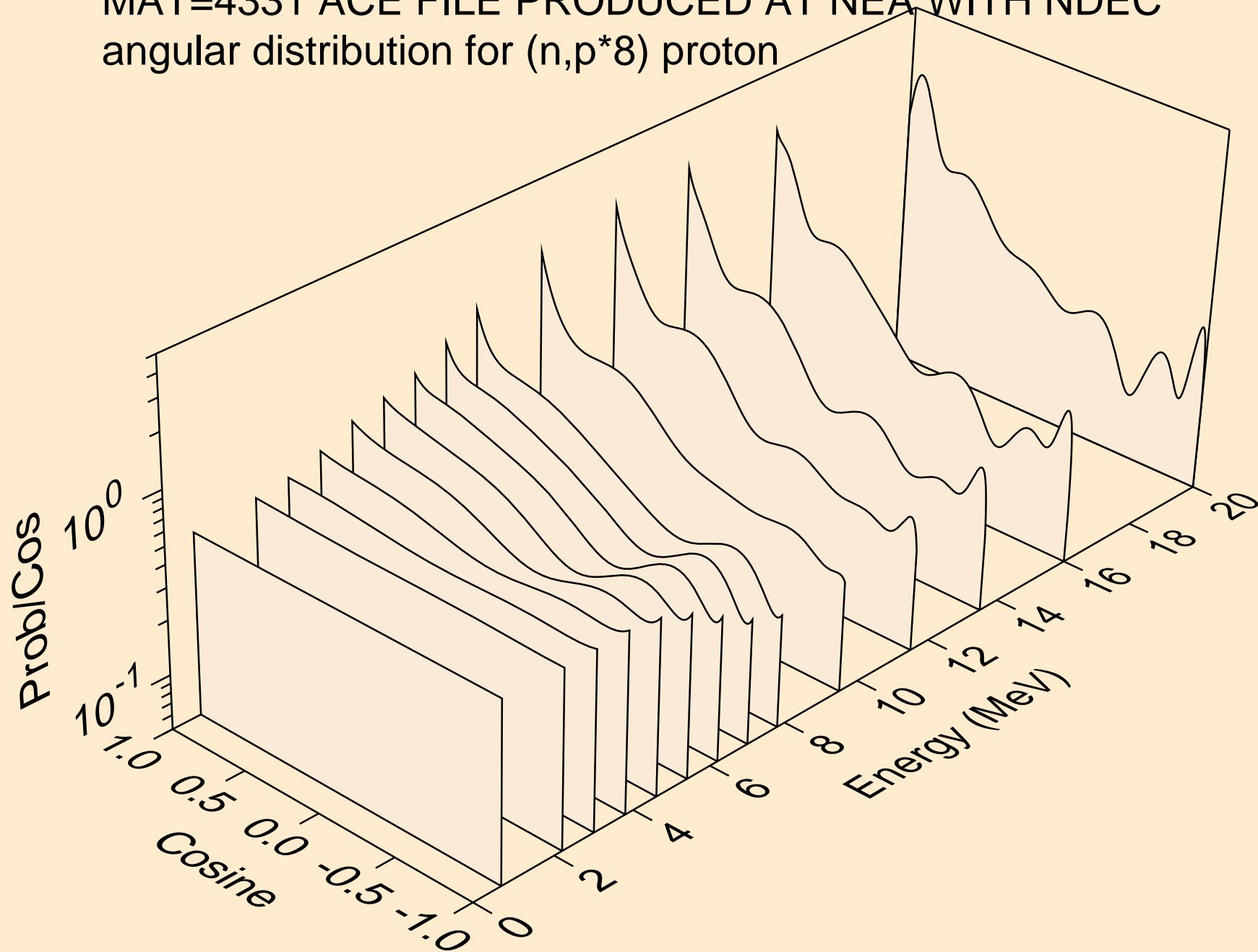

MAT=4331 ACE FILE PRODUCED AT NEA WITH NDEC
angular distribution for (n,p*9) proton

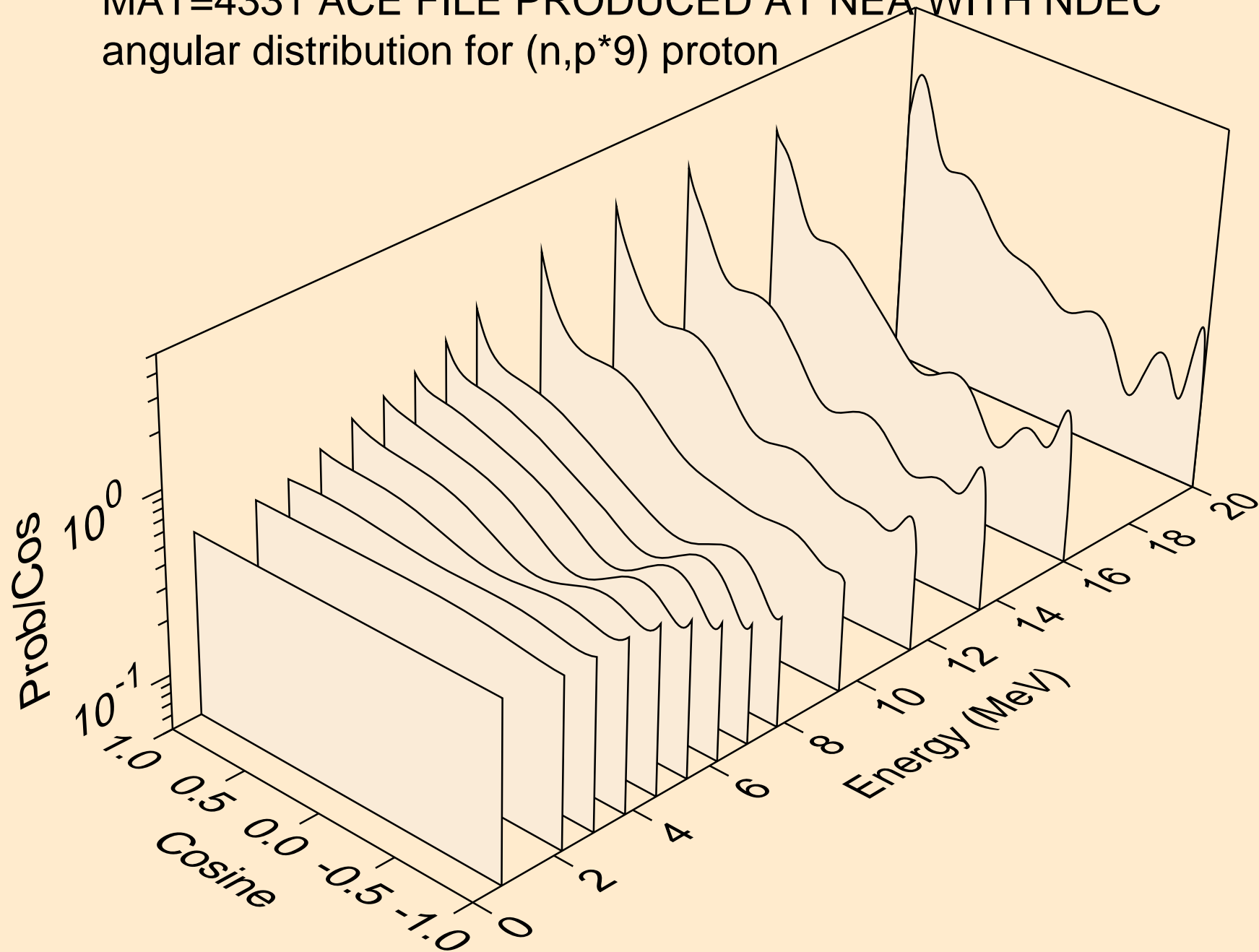

MAT=4331 ACE FILE PRODUCED AT NEA WITH NDEC
angular distribution for (n,p*10) proton

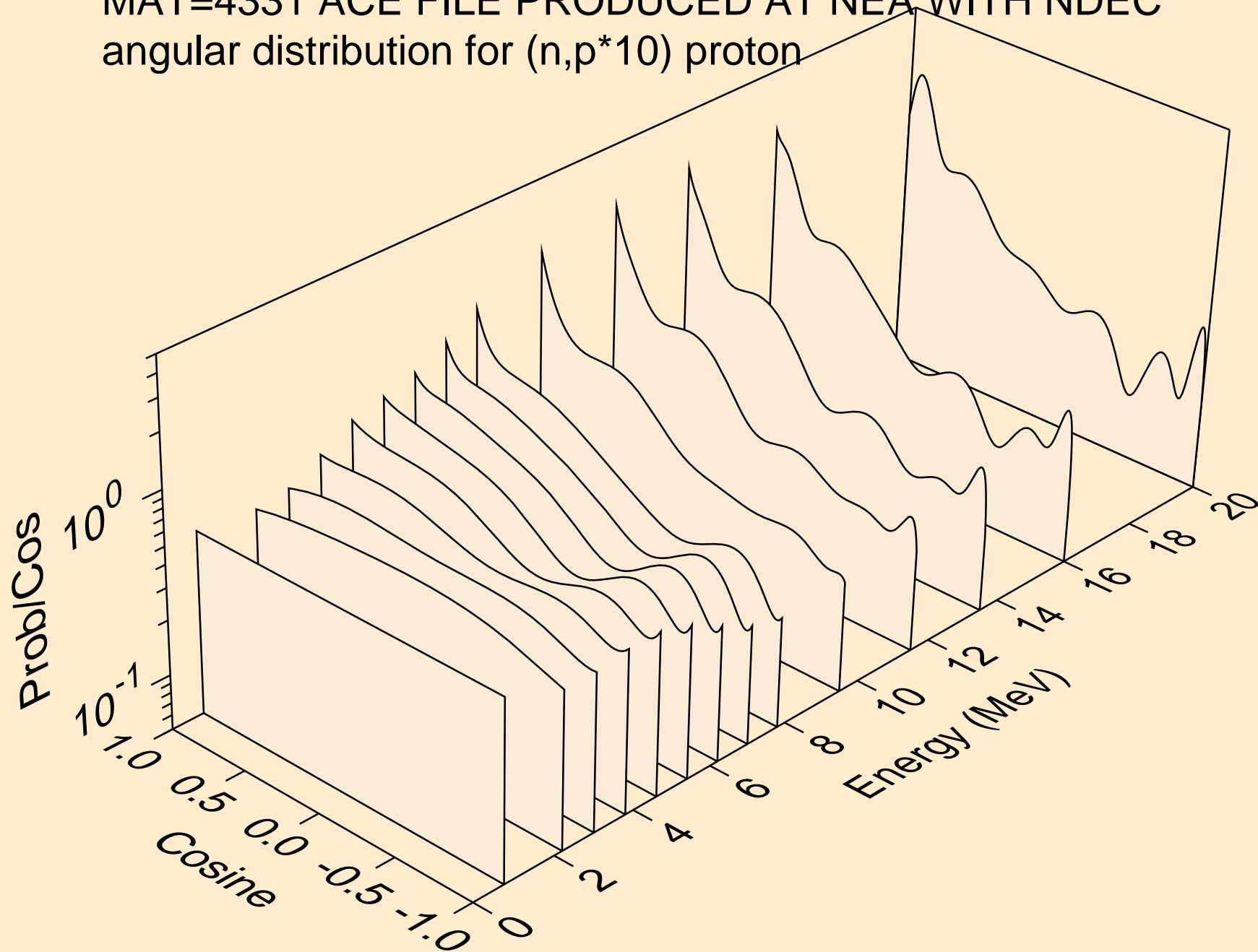

MAT=4331 ACE FILE PRODUCED AT NEA WITH NDEC
protons from (n,p*c)

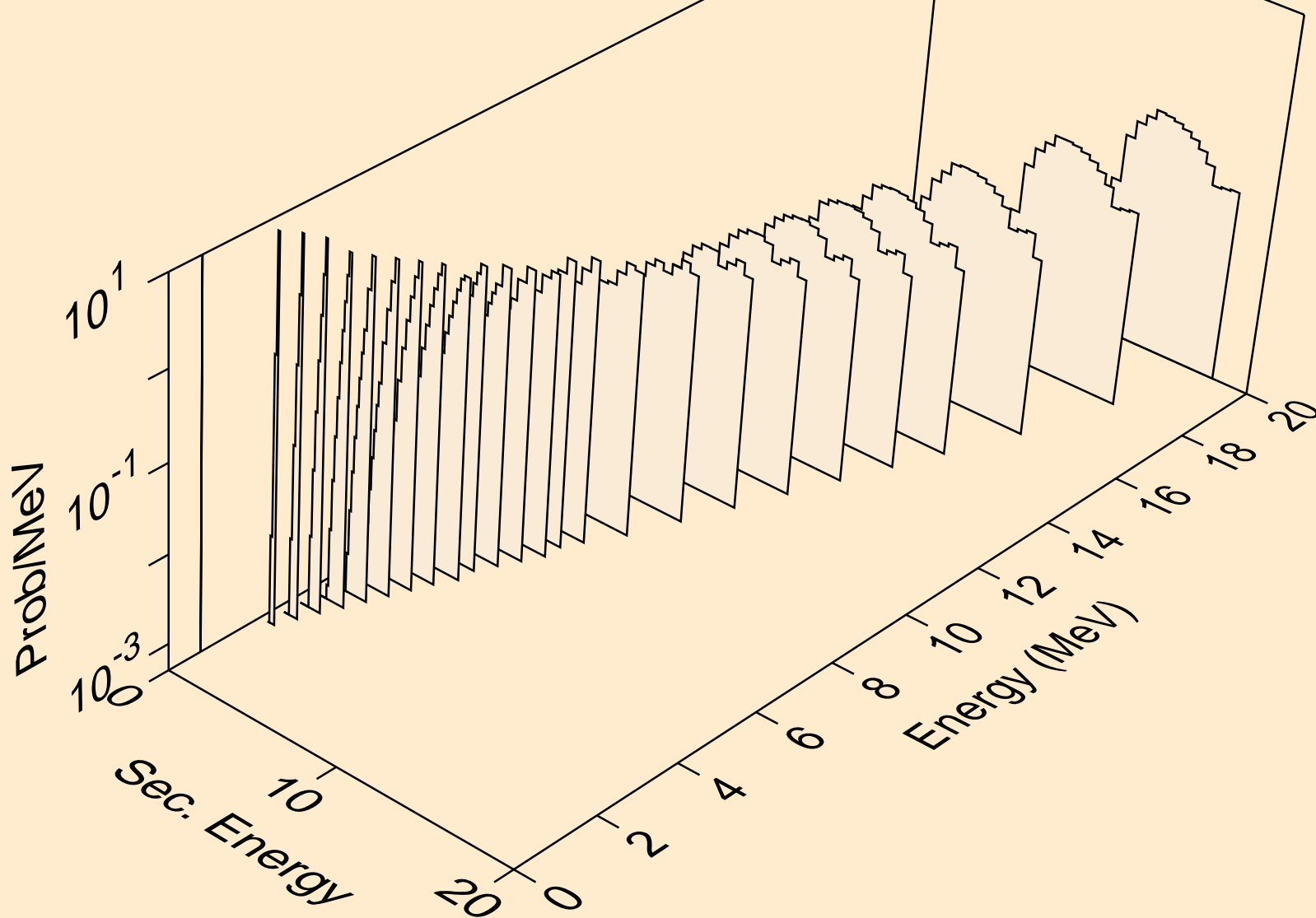

MAT=4331 ACE FILE PRODUCED AT NEA WITH NDEC
deuterons from (n,x)

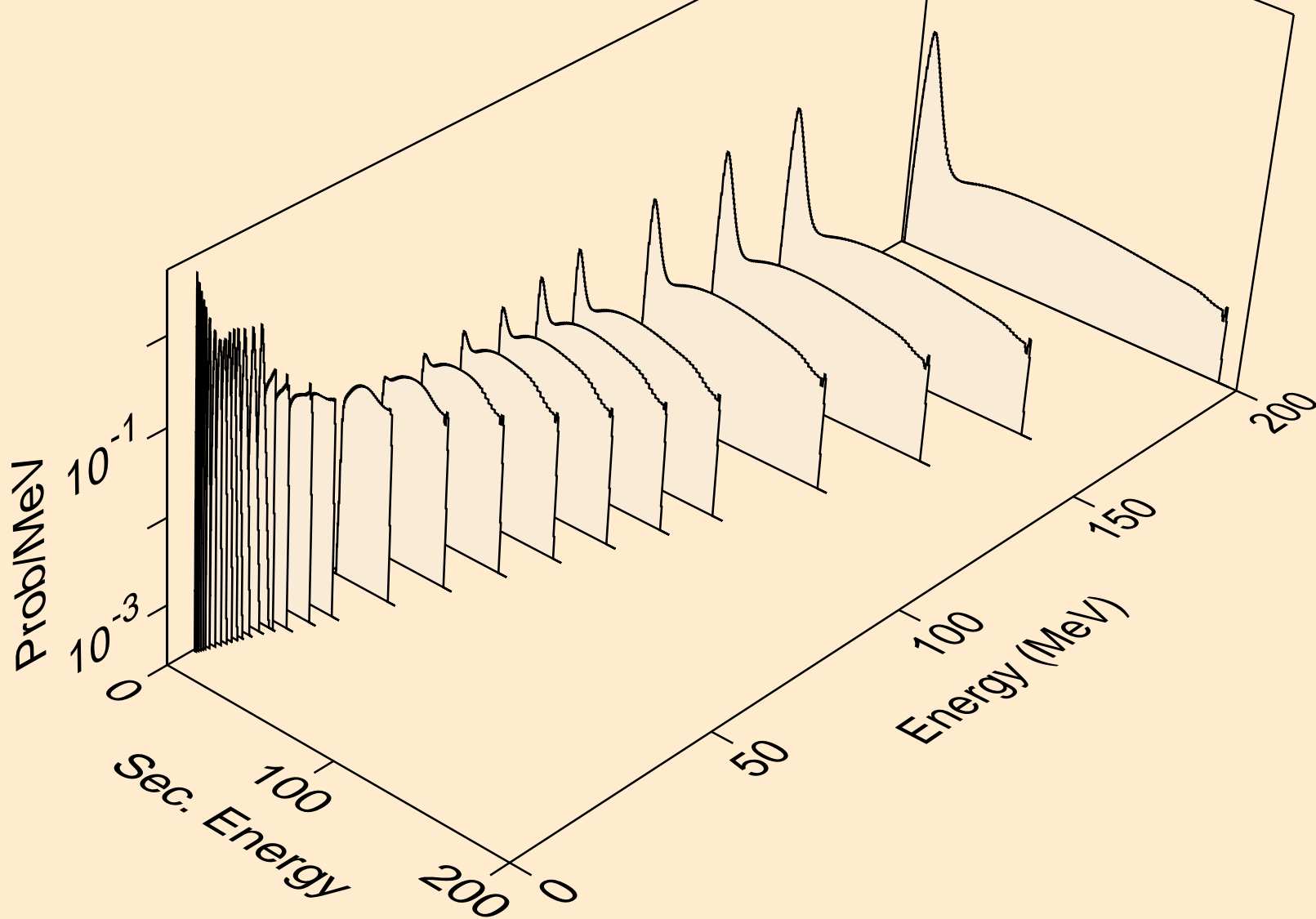

MAT=4331 ACE FILE PRODUCED AT NEA WITH NDEC
deuterons from (n,n*)d

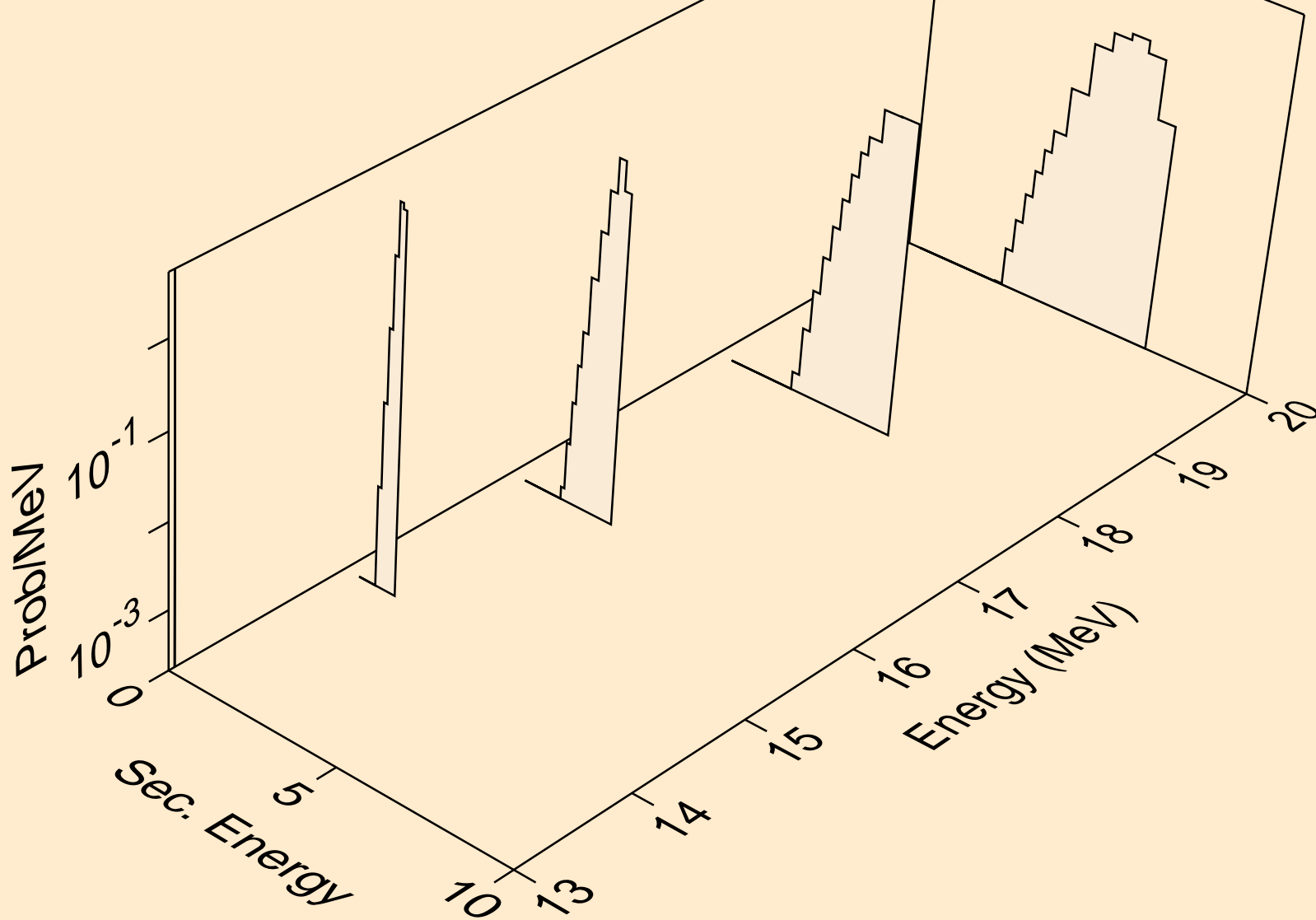

MAT=4331 ACE FILE PRODUCED AT NEA WITH NDEC
angular distribution for (n,d*0) deuteron

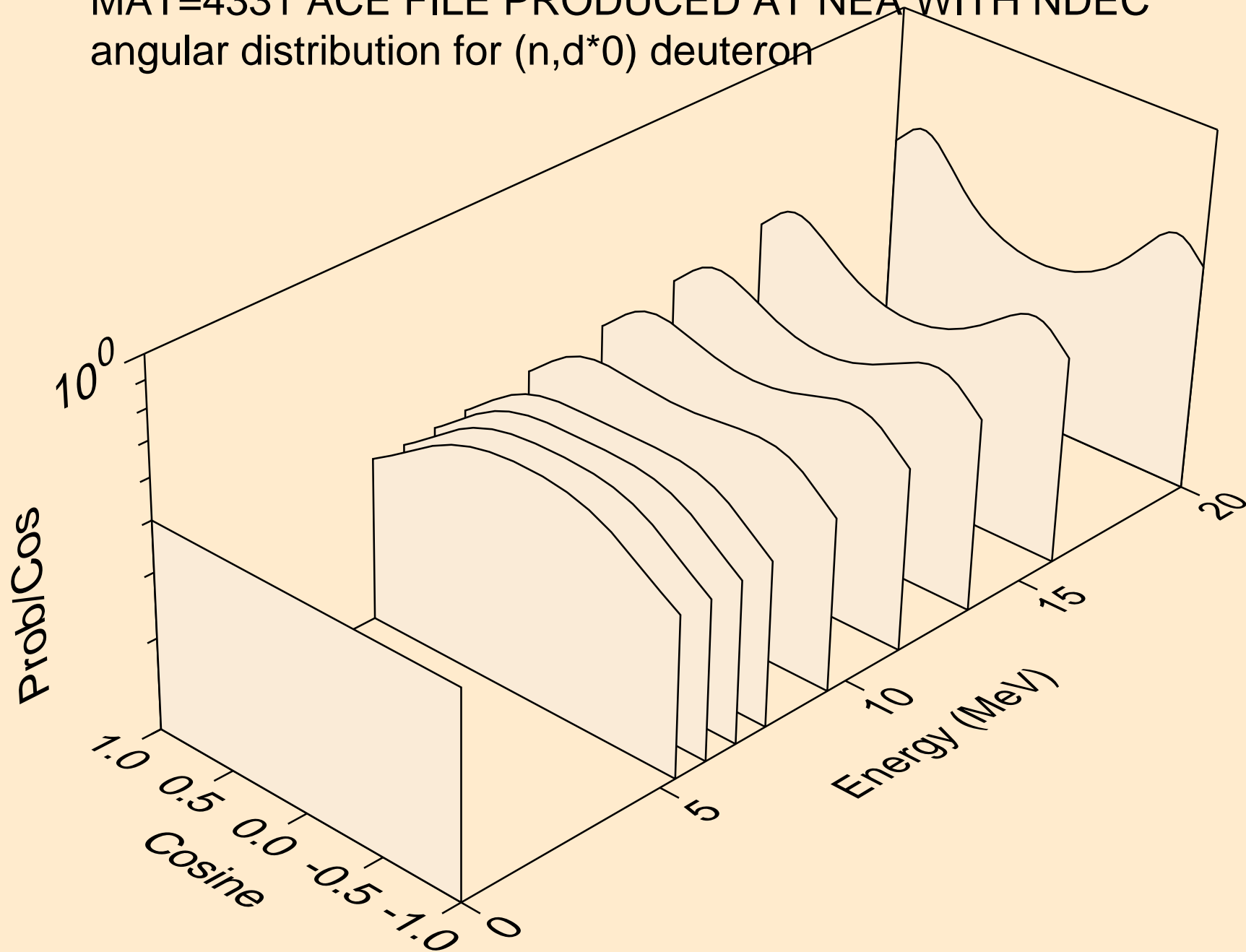

MAT=4331 ACE FILE PRODUCED AT NEA WITH NDEC
angular distribution for (n,d*1) deuteron

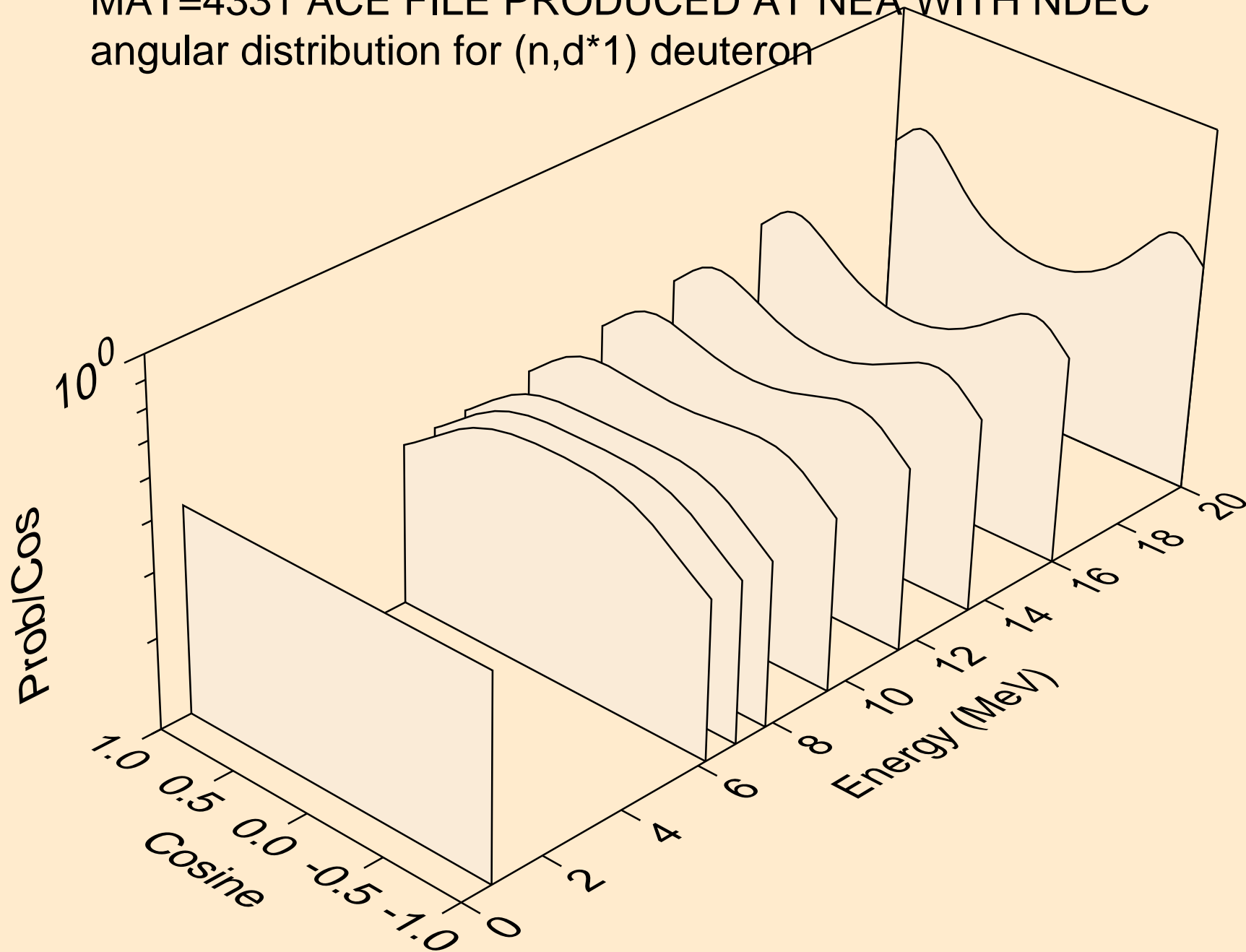

MAT=4331 ACE FILE PRODUCED AT NEA WITH NDEC
angular distribution for (n,d*2) deuteron

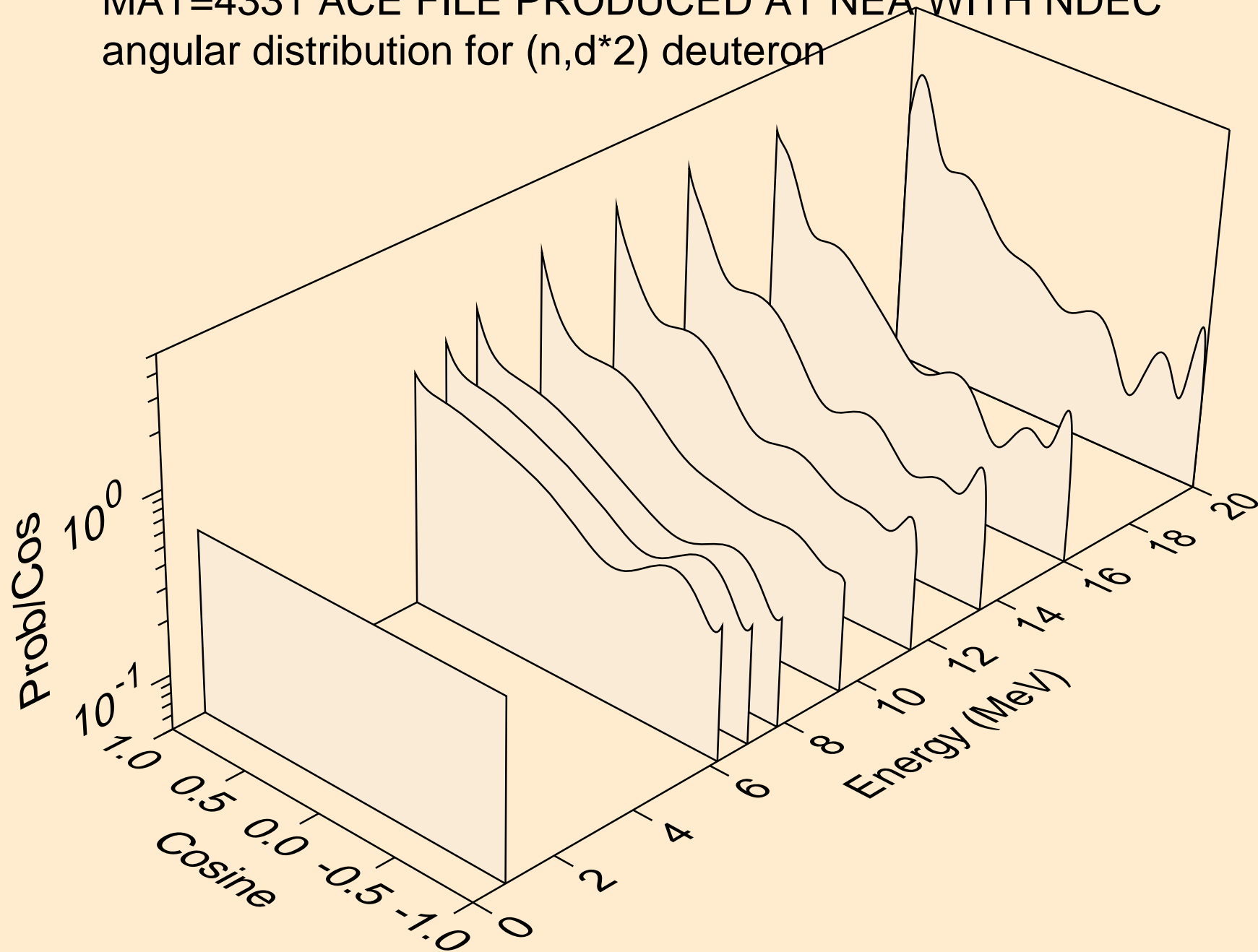

MAT=4331 ACE FILE PRODUCED AT NEA WITH NDEC
angular distribution for (n,d*3) deuteron

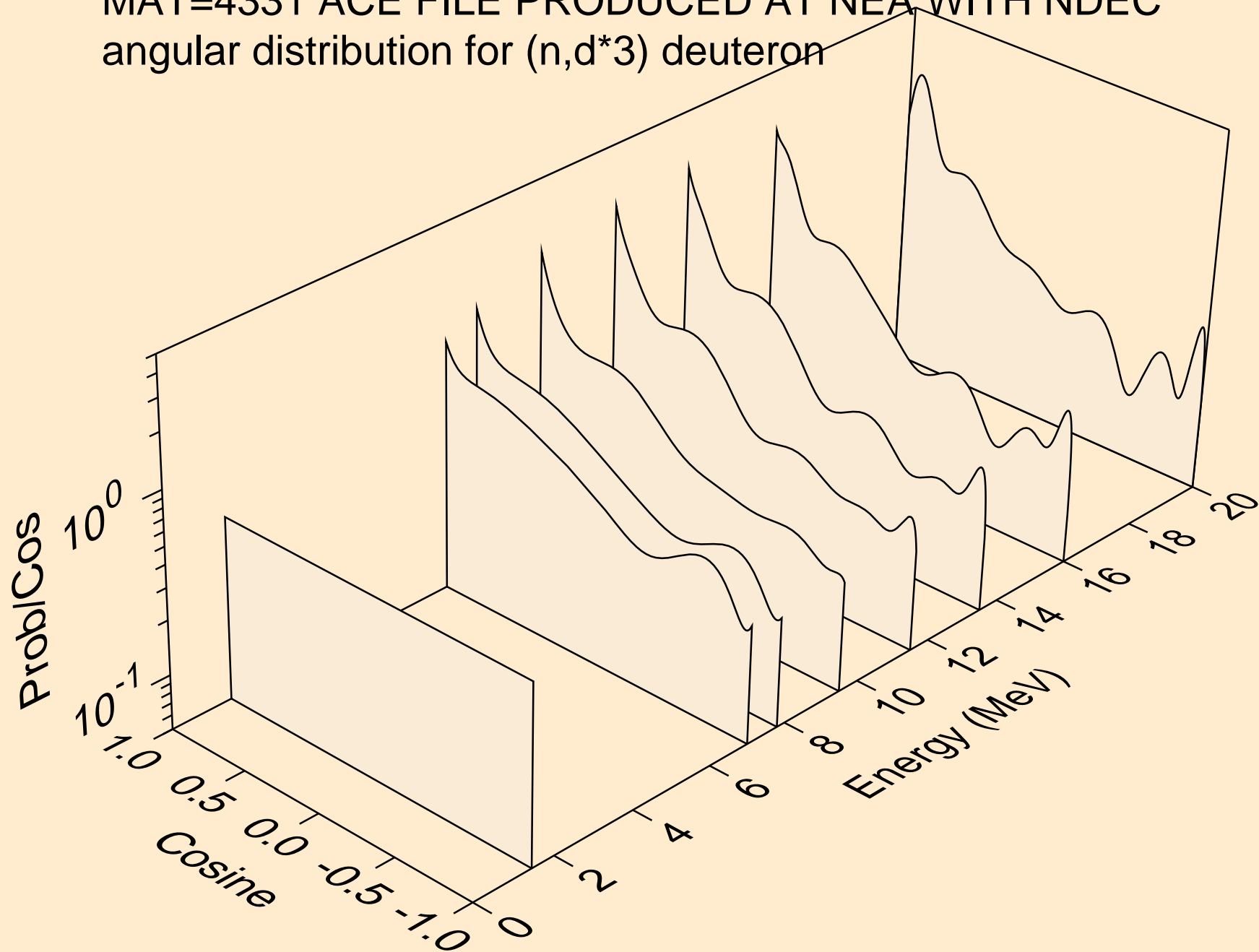

MAT=4331 ACE FILE PRODUCED AT NEA WITH NDEC
angular distribution for (n,d*4) deuteron

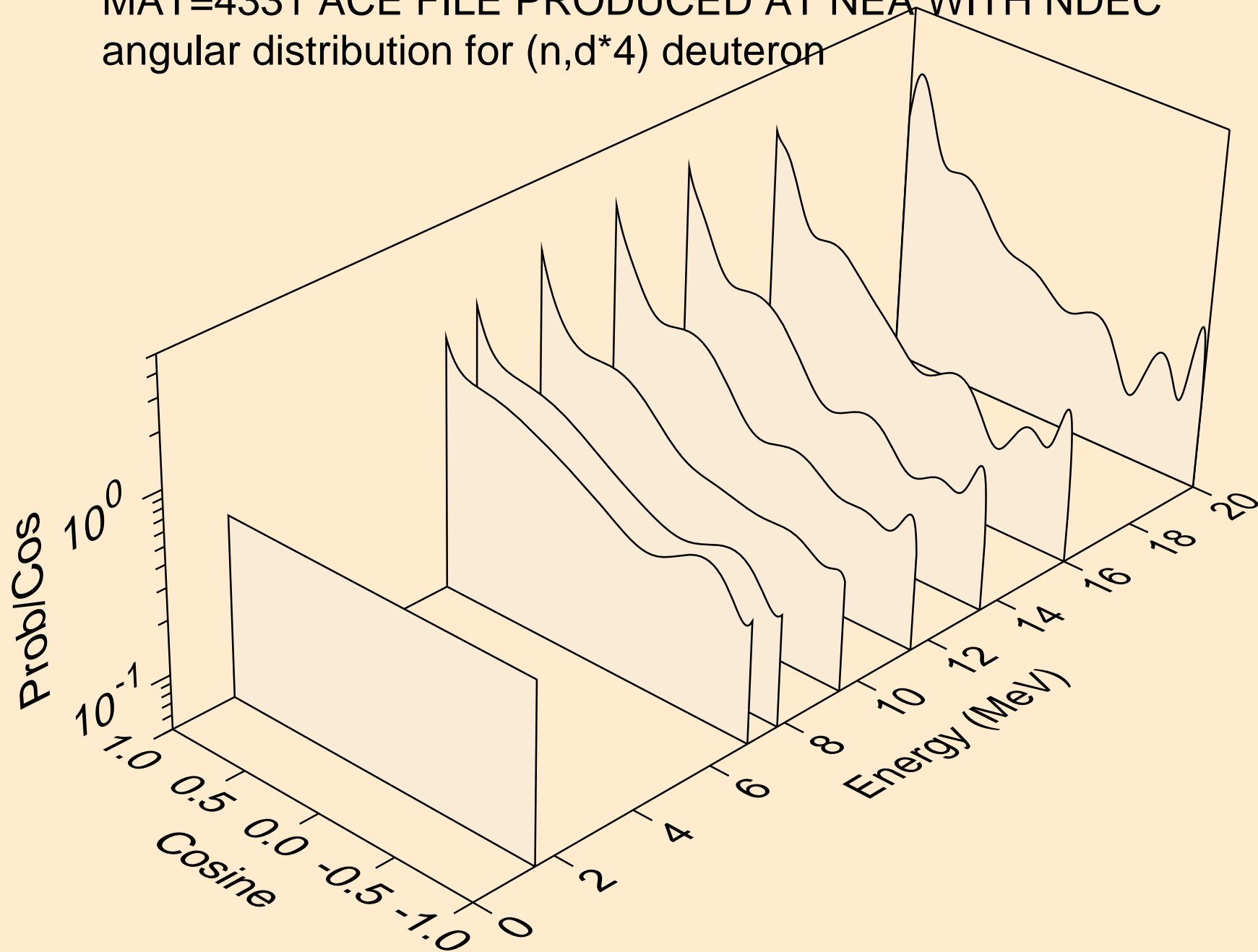

MAT=4331 ACE FILE PRODUCED AT NEA WITH NDEC
angular distribution for (n,d*5) deuteron

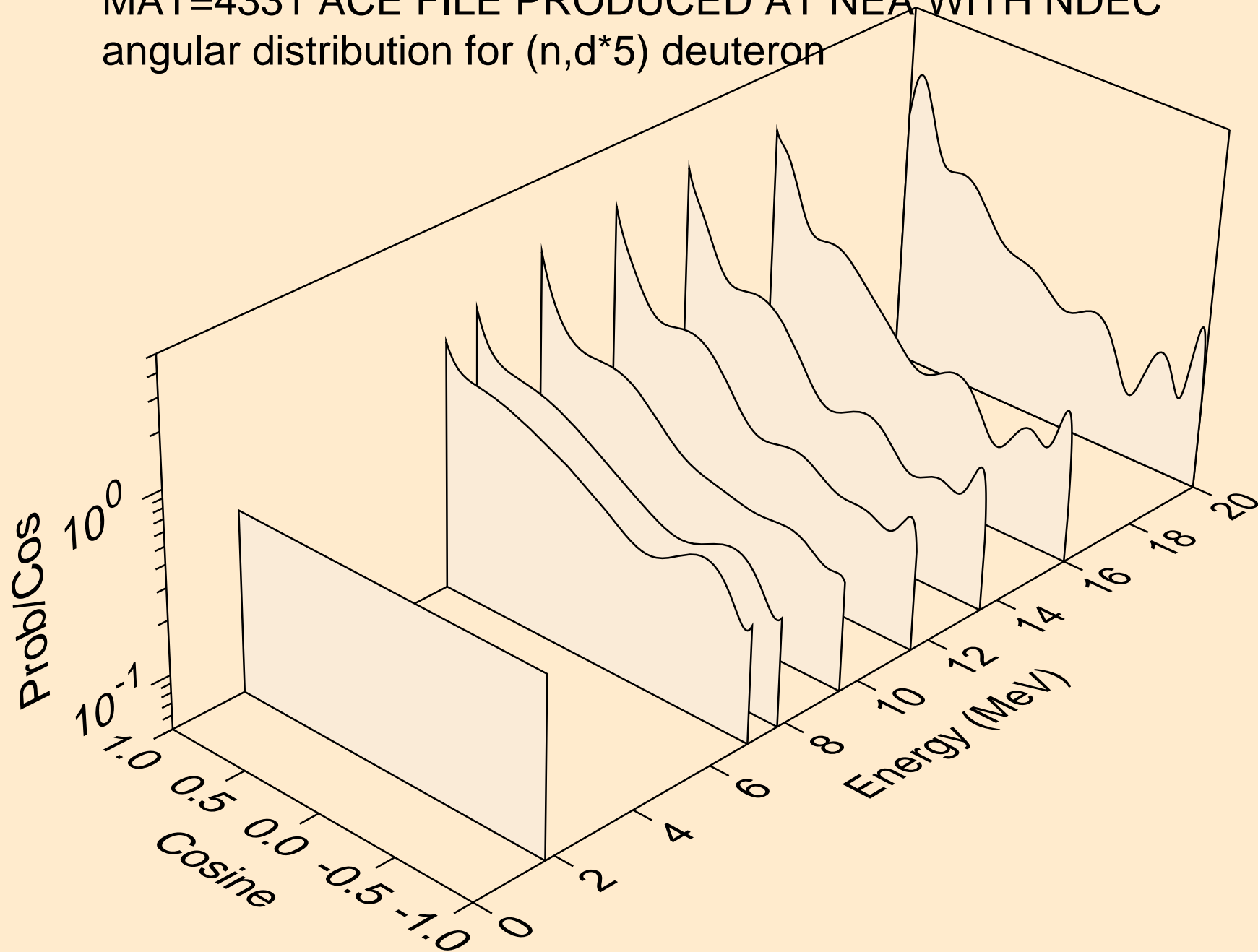

MAT=4331 ACE FILE PRODUCED AT NEA WITH NDEC
deuterons from (n,d*c)

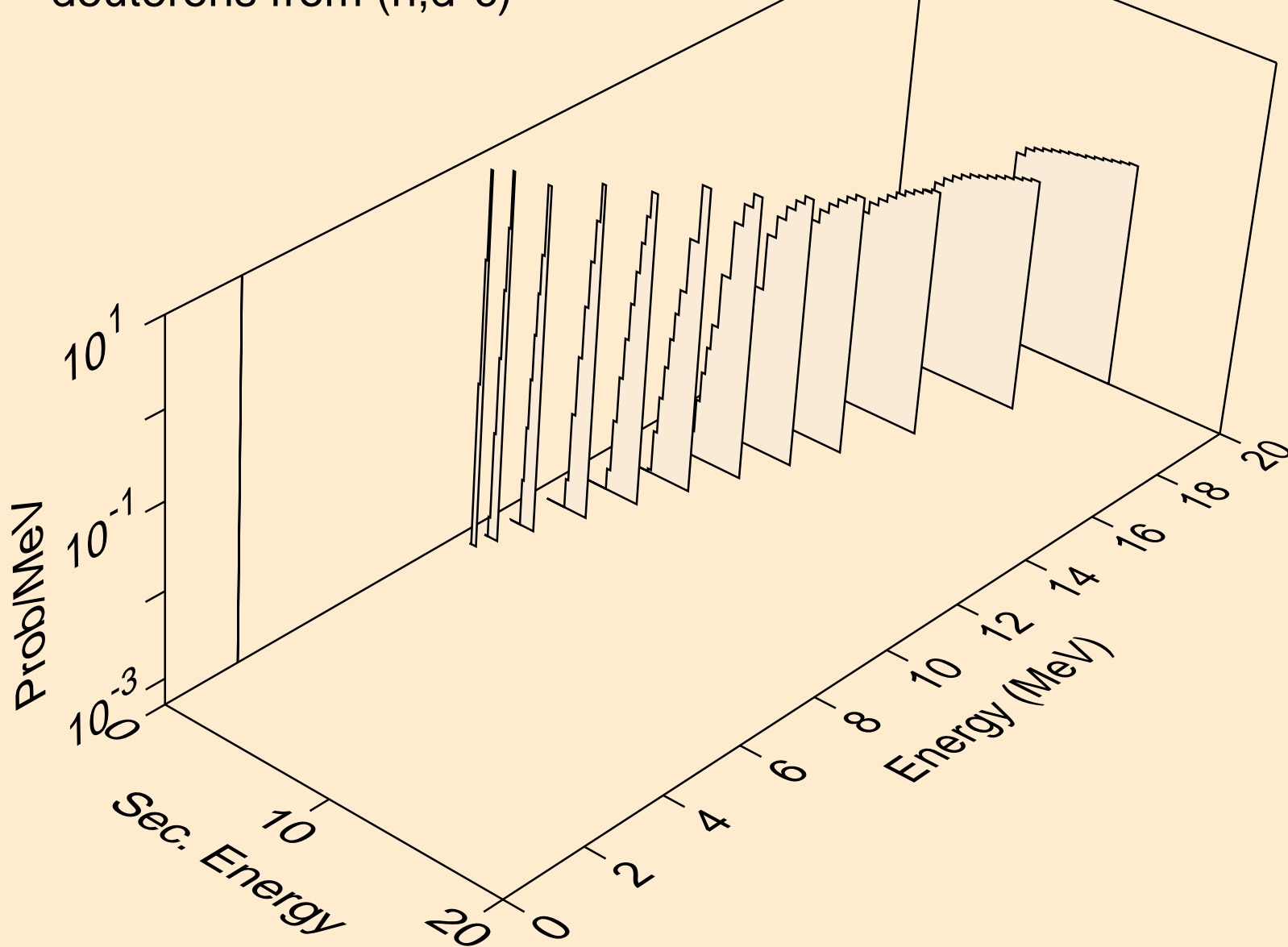

MAT=4331 ACE FILE PRODUCED AT NEA WITH NDEC
tritons from (n,x)

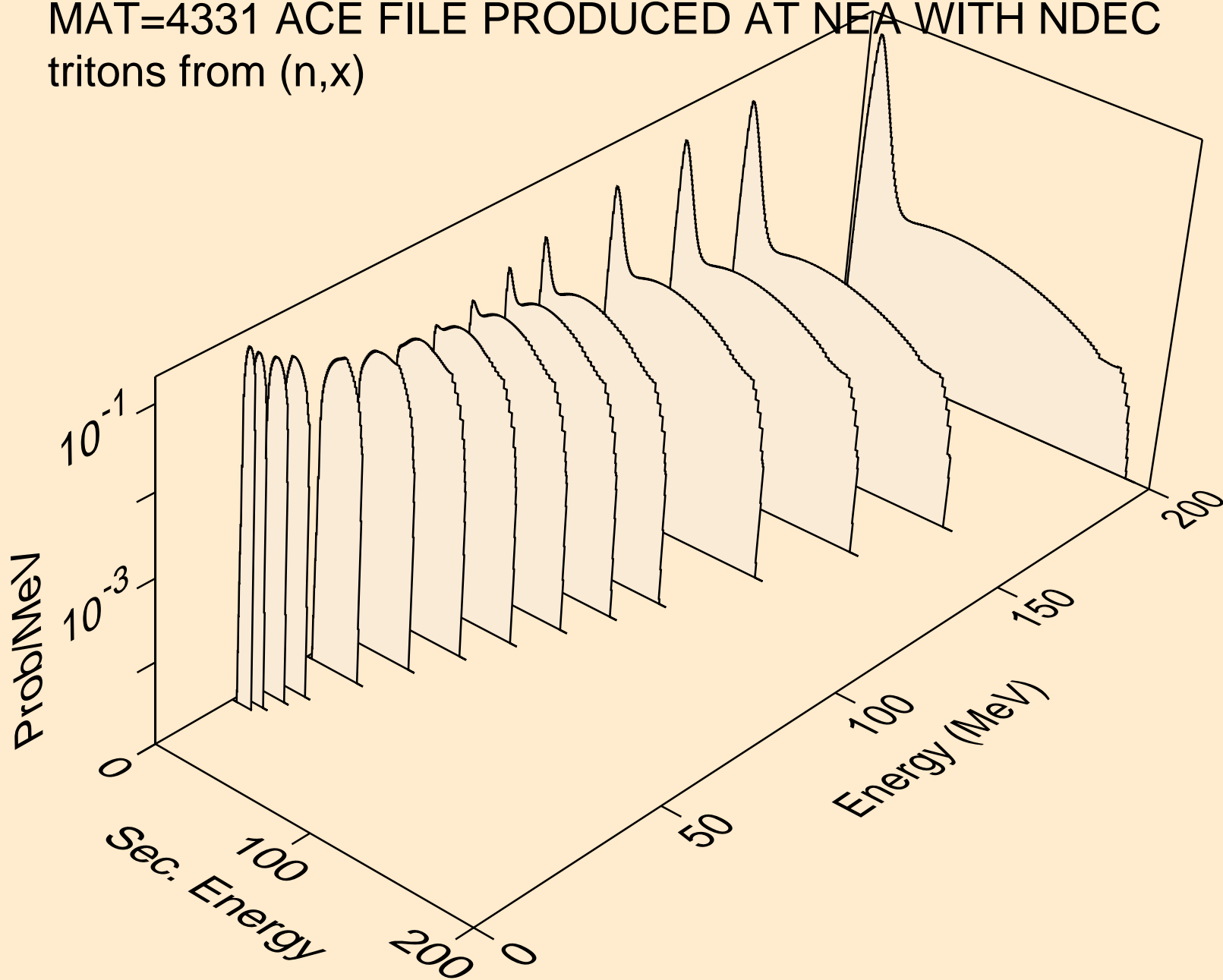

MAT=4331 ACE FILE PRODUCED AT NEA WITH NDEC
tritons from (n,n*)t

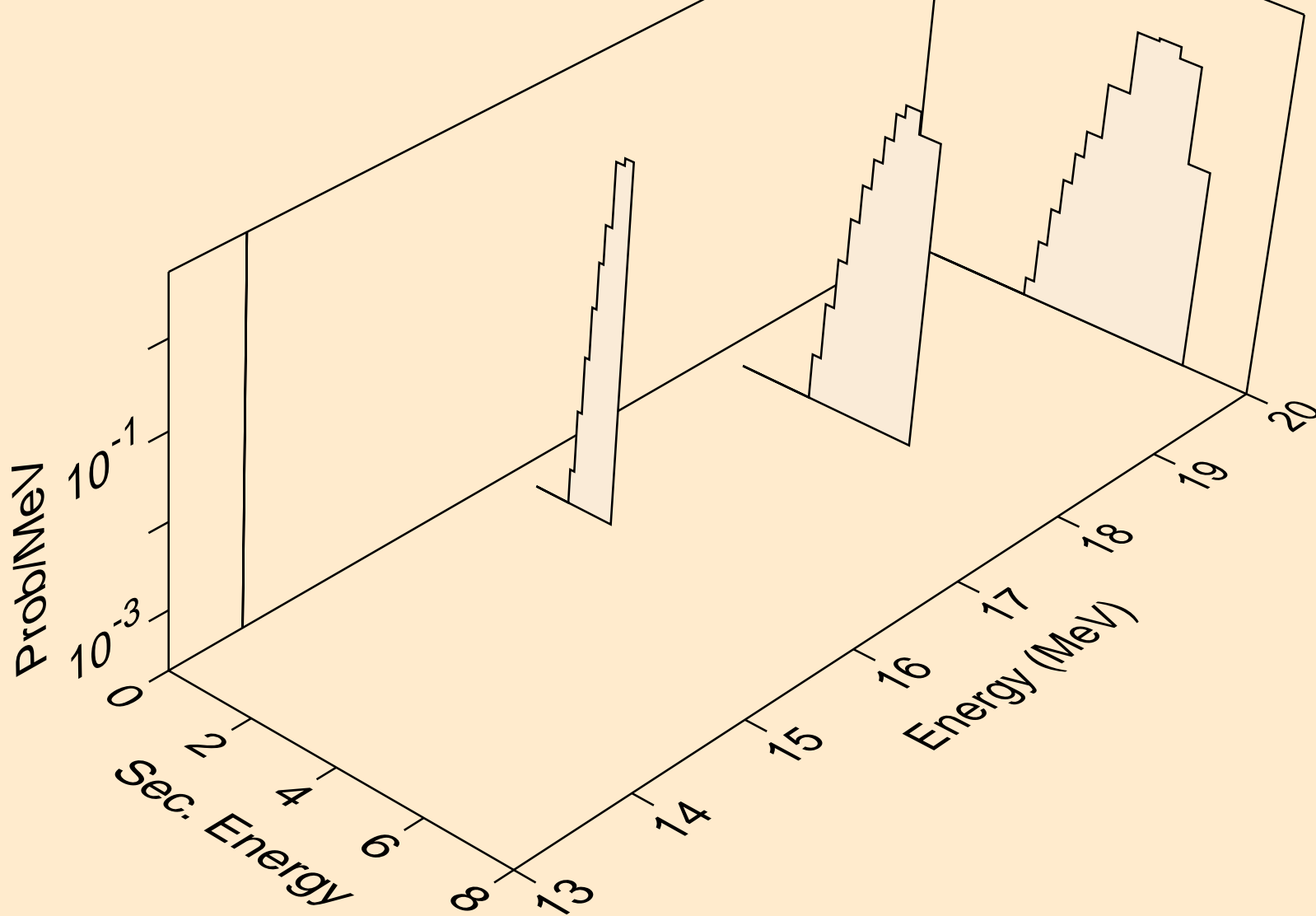

MAT=4331 ACE FILE PRODUCED AT NEA WITH NDEC
angular distribution for (n,t*0) triton

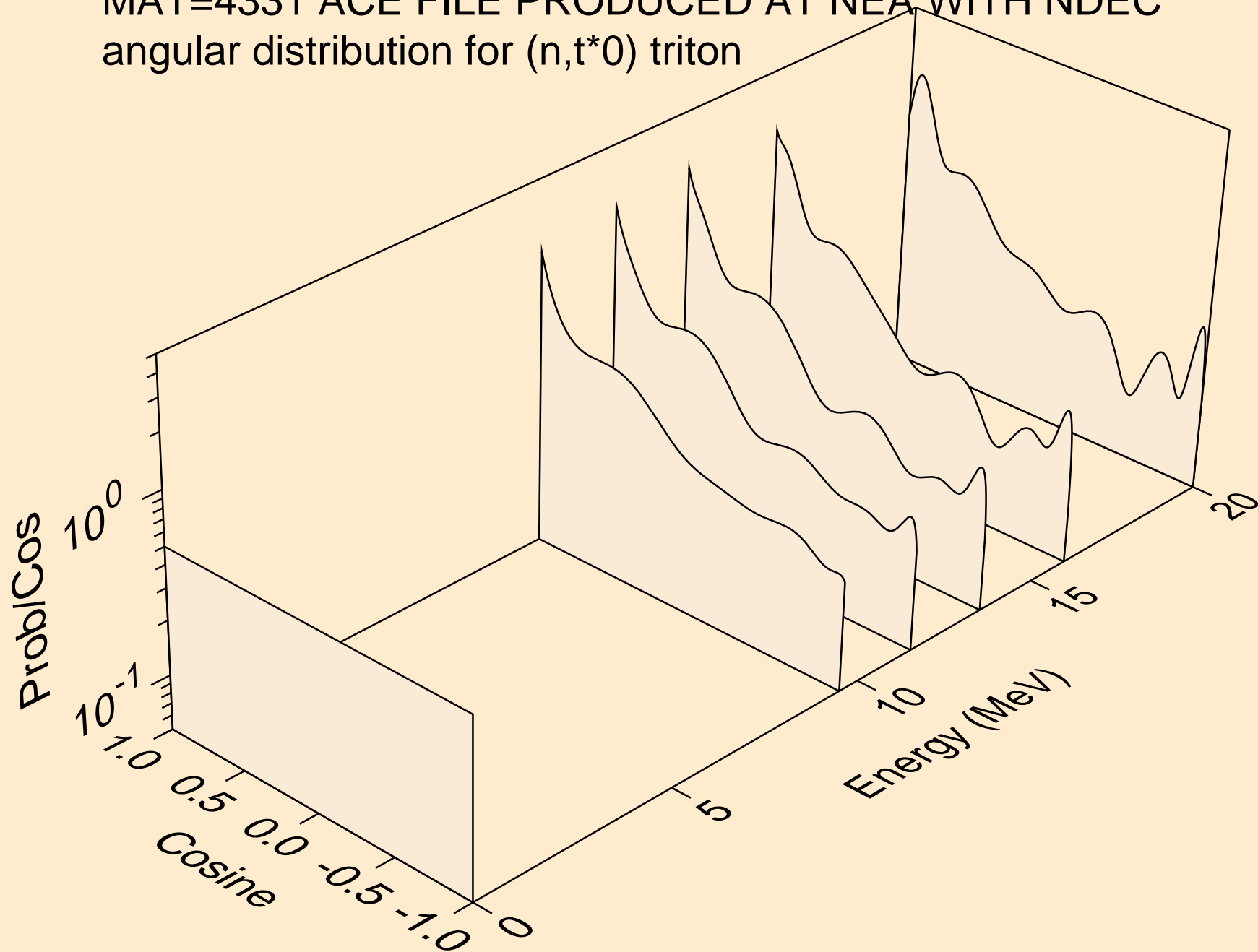

MAT=4331 ACE FILE PRODUCED AT NEA WITH NDEC
angular distribution for (n,t*1) triton

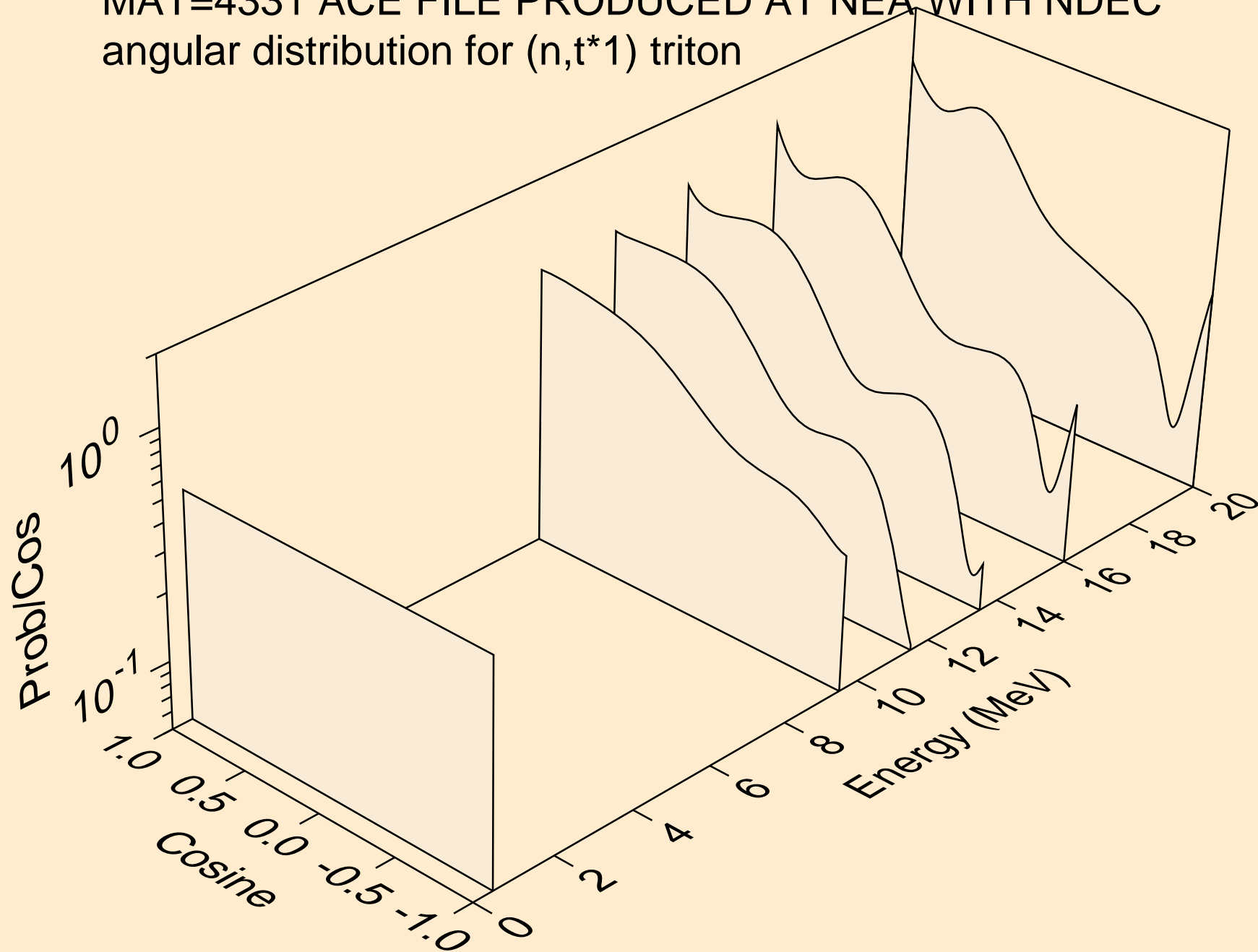

MAT=4331 ACE FILE PRODUCED AT NEA WITH NDEC
angular distribution for (n,t*2) triton

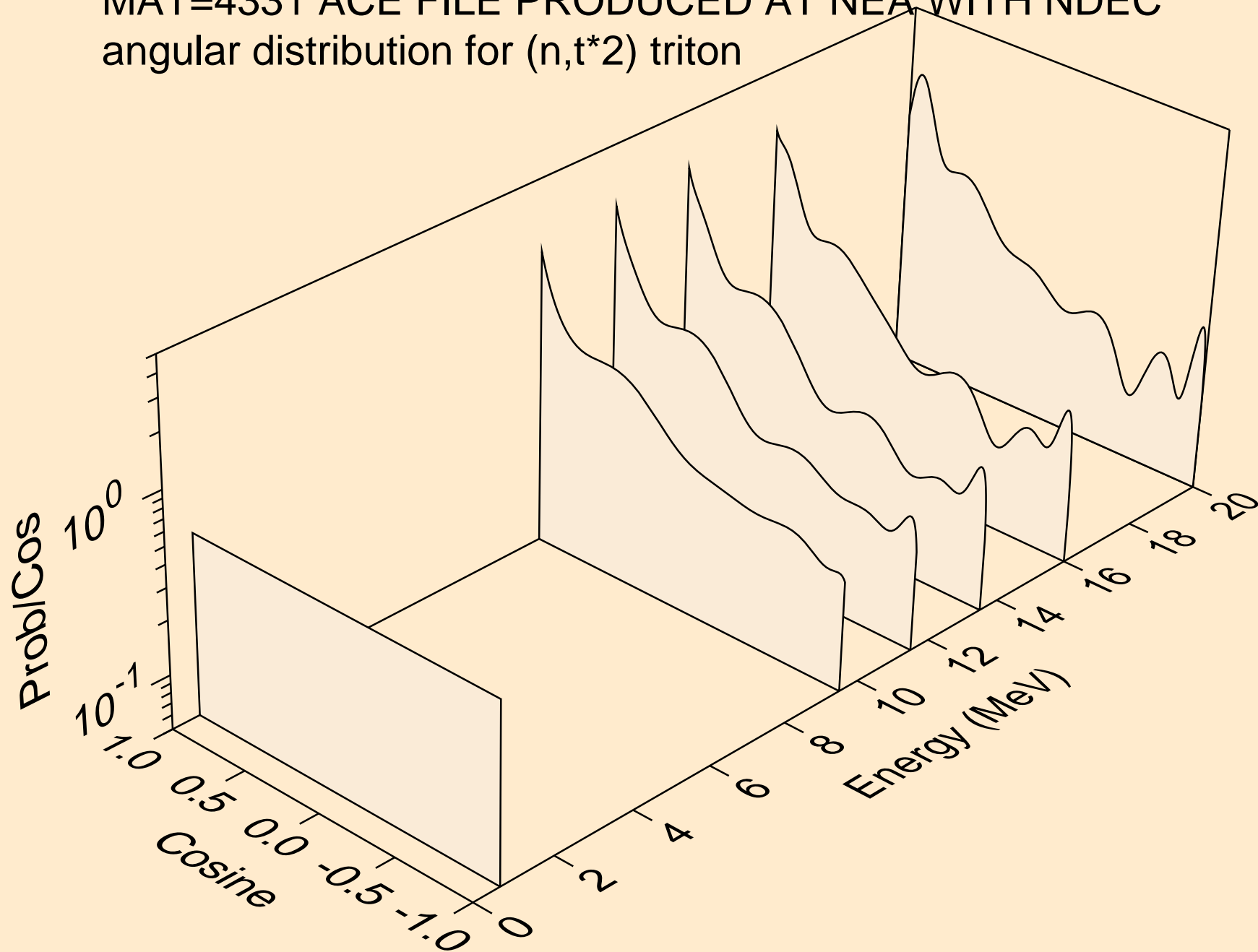

MAT=4331 ACE FILE PRODUCED AT NEA WITH NDEC
angular distribution for (n,t*3) triton

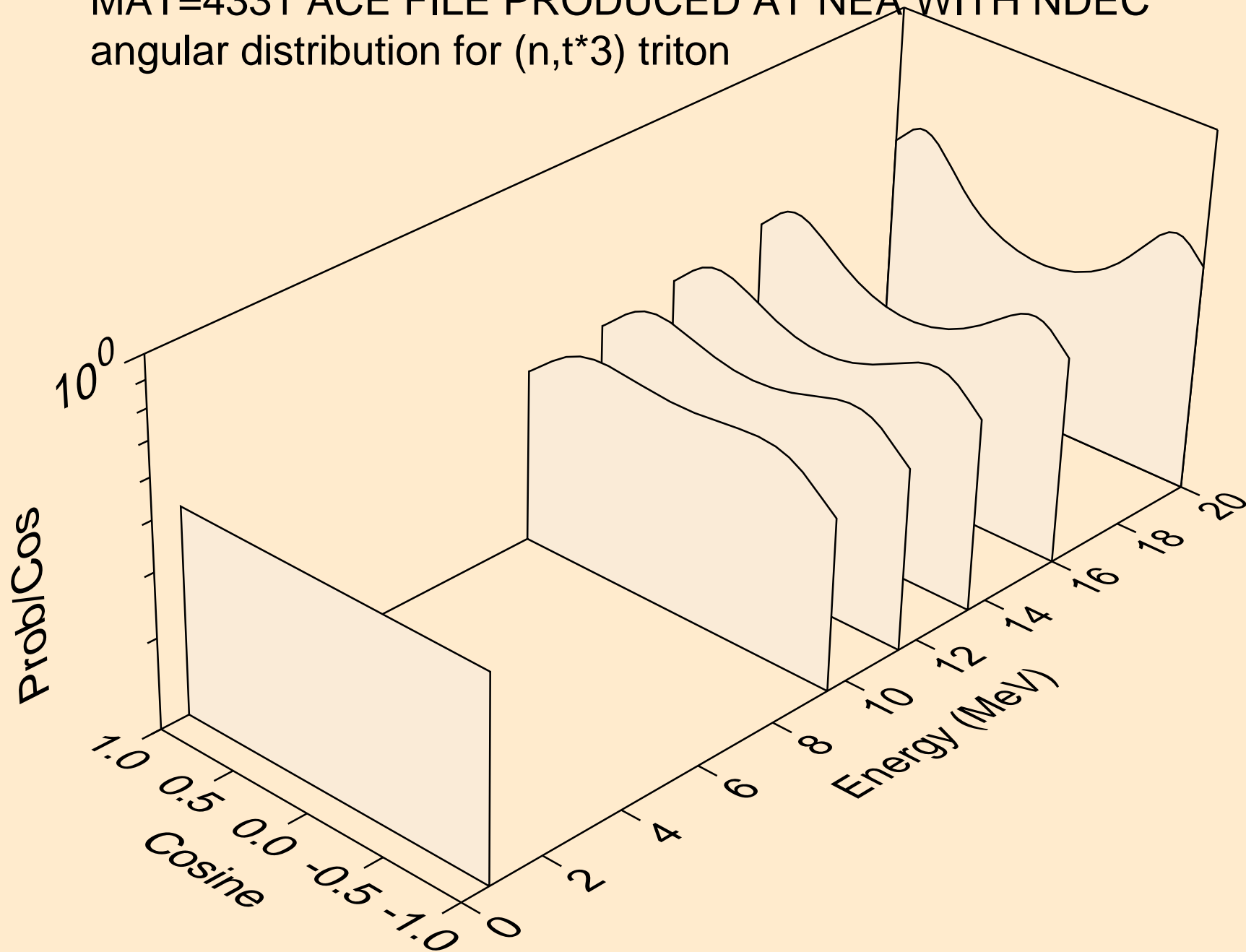

MAT=4331 ACE FILE PRODUCED AT NEA WITH NDEC
angular distribution for (n,t*4) triton

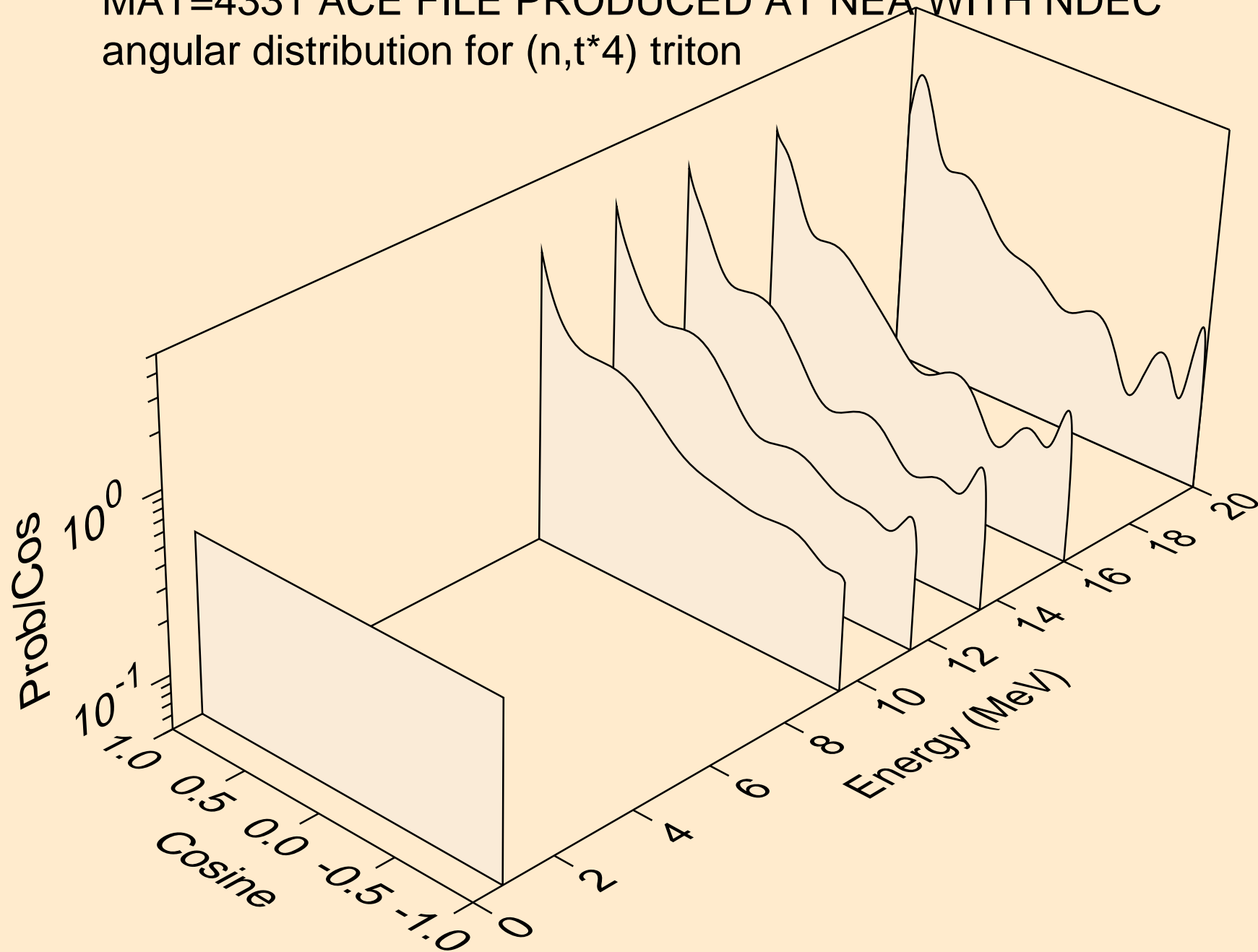

MAT=4331 ACE FILE PRODUCED AT NEA WITH NDEC
angular distribution for (n,t*5) triton

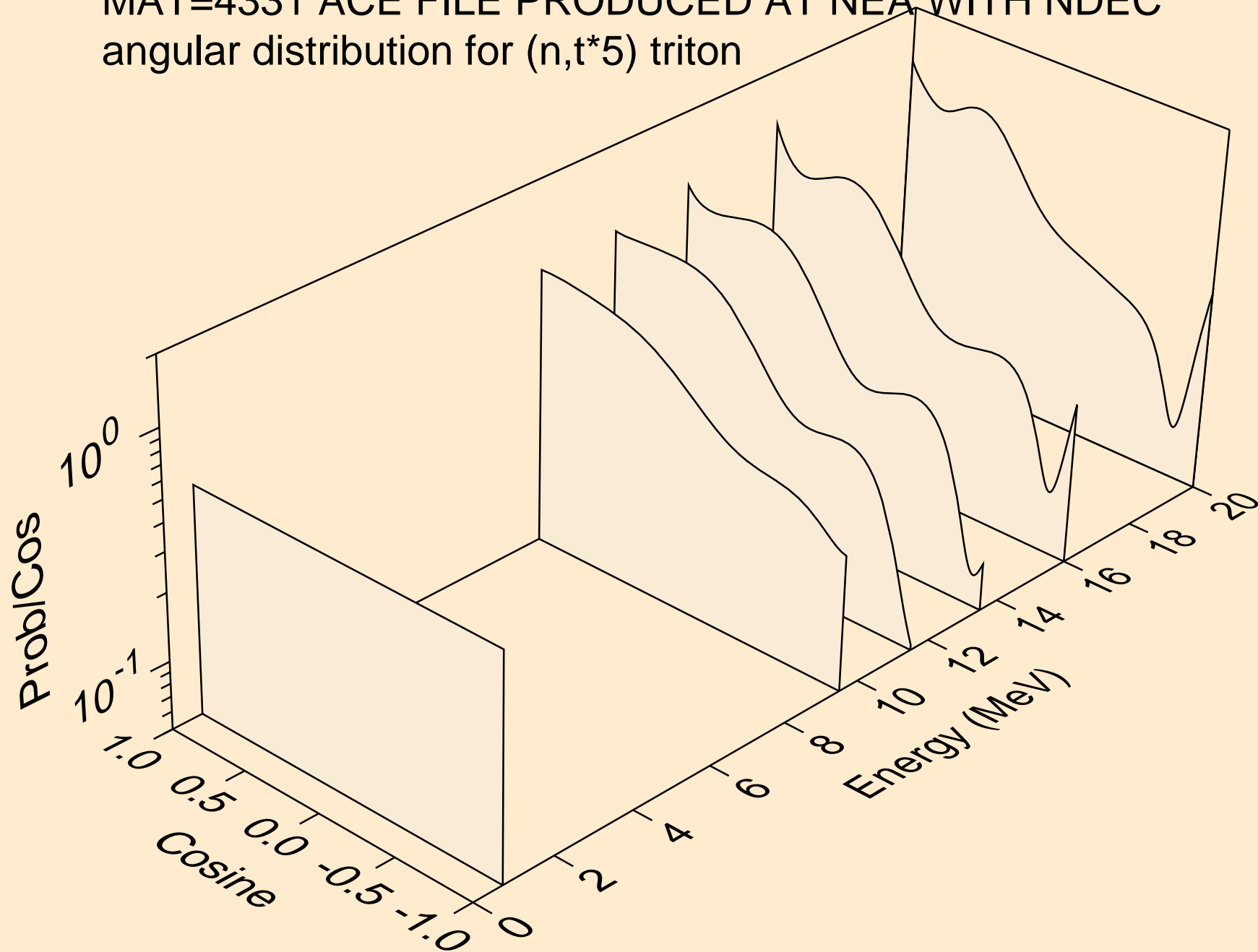

MAT=4331 ACE FILE PRODUCED AT NEA WITH NDEC
tritons from (n,t*c)

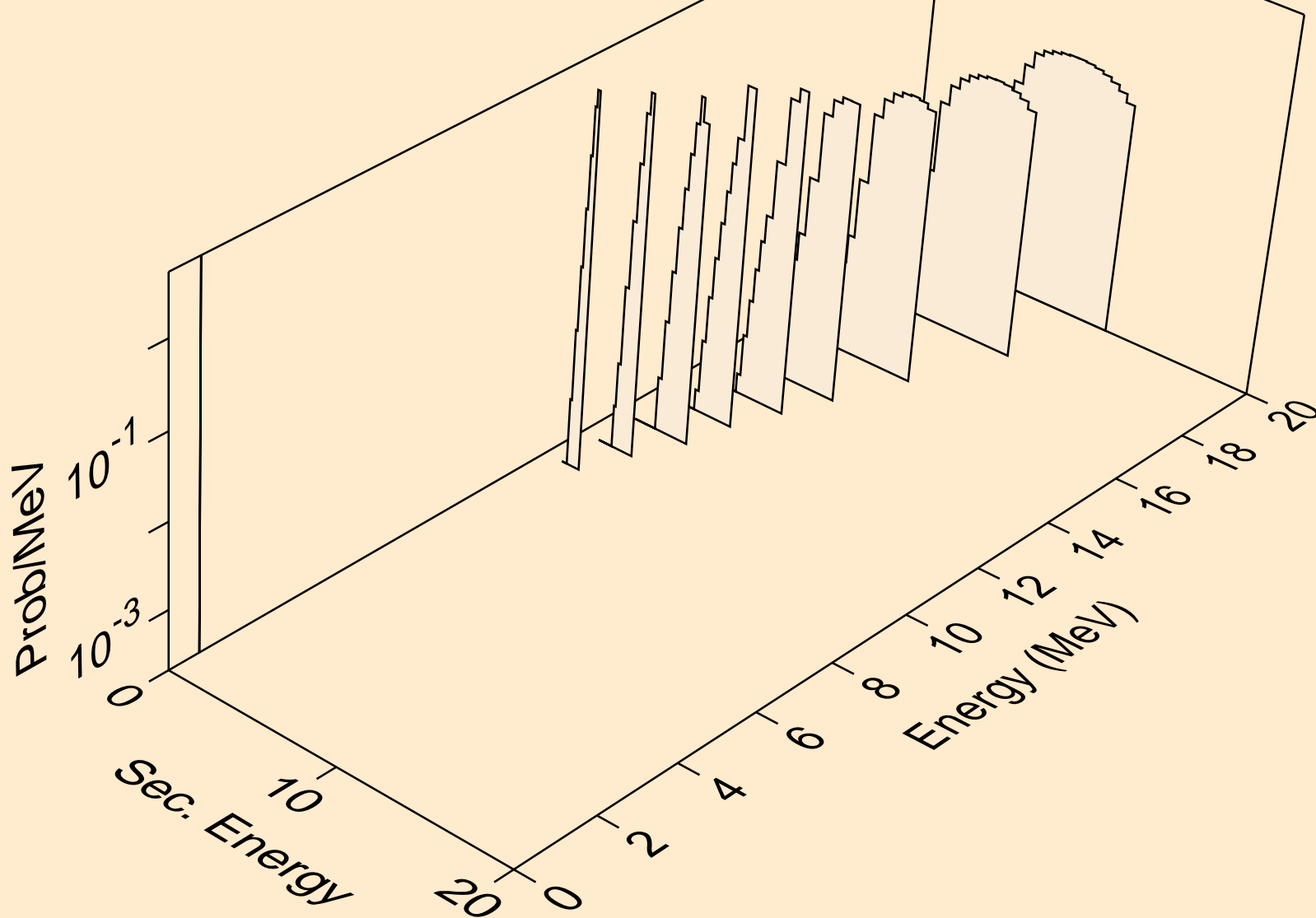

MAT=4331 ACE FILE PRODUCED AT NEA WITH NDEC
he3s from (n,x)

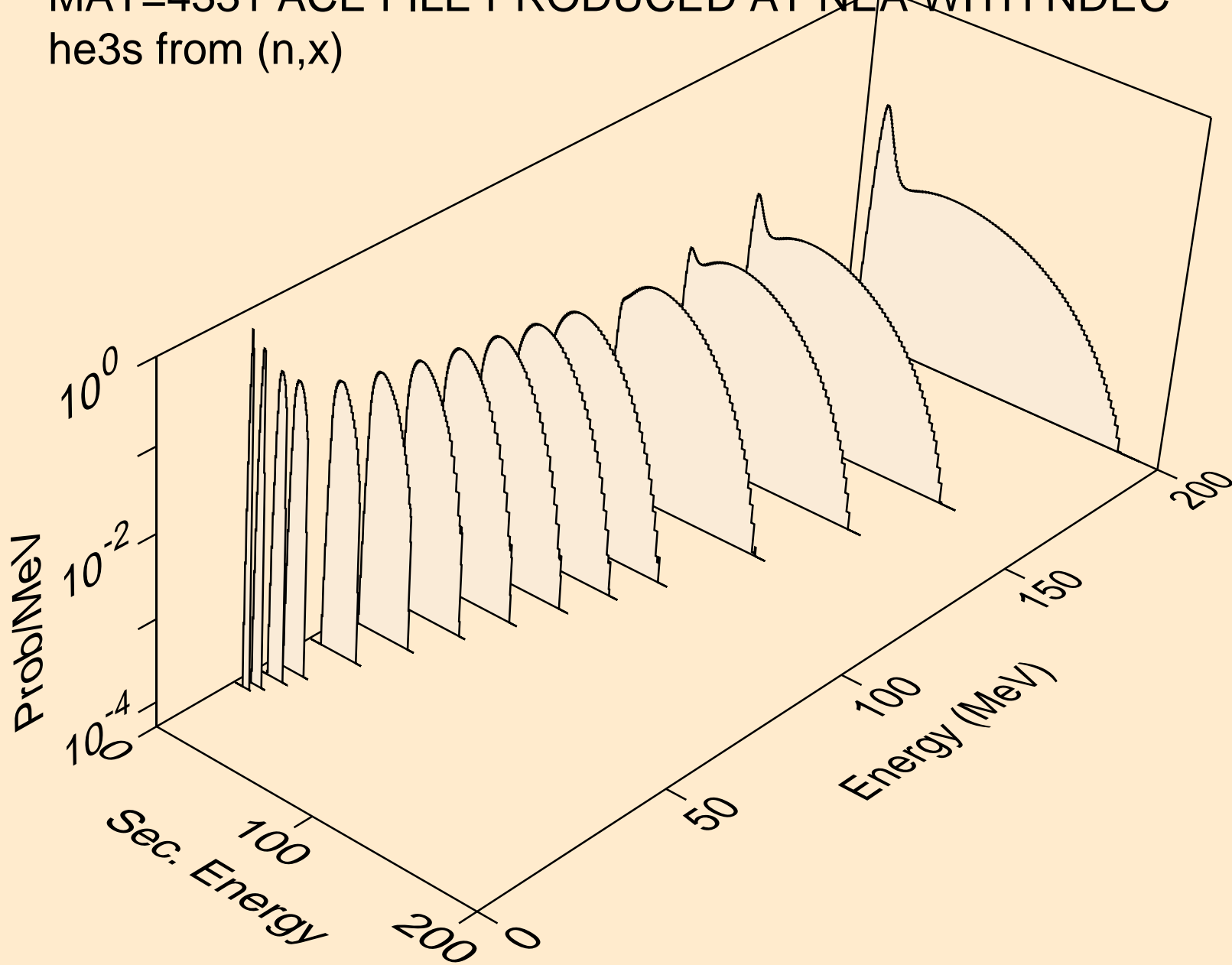

MAT=4331 ACE FILE PRODUCED AT NEA WITH NDEC
angular distribution for (n,he3*0) 3he

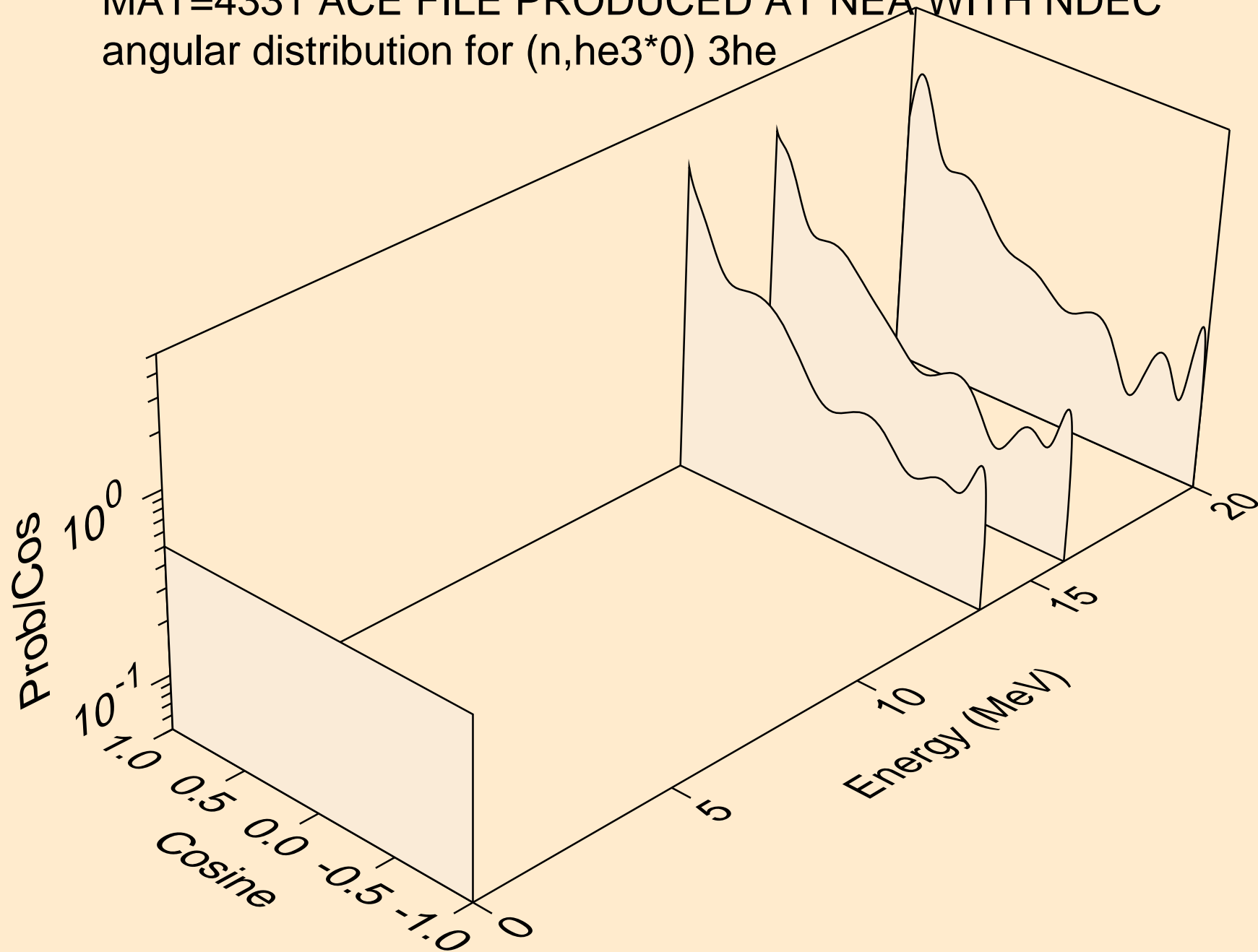

MAT=4331 ACE FILE PRODUCED AT NEA WITH NDEC
angular distribution for (n,he3*1) 3he

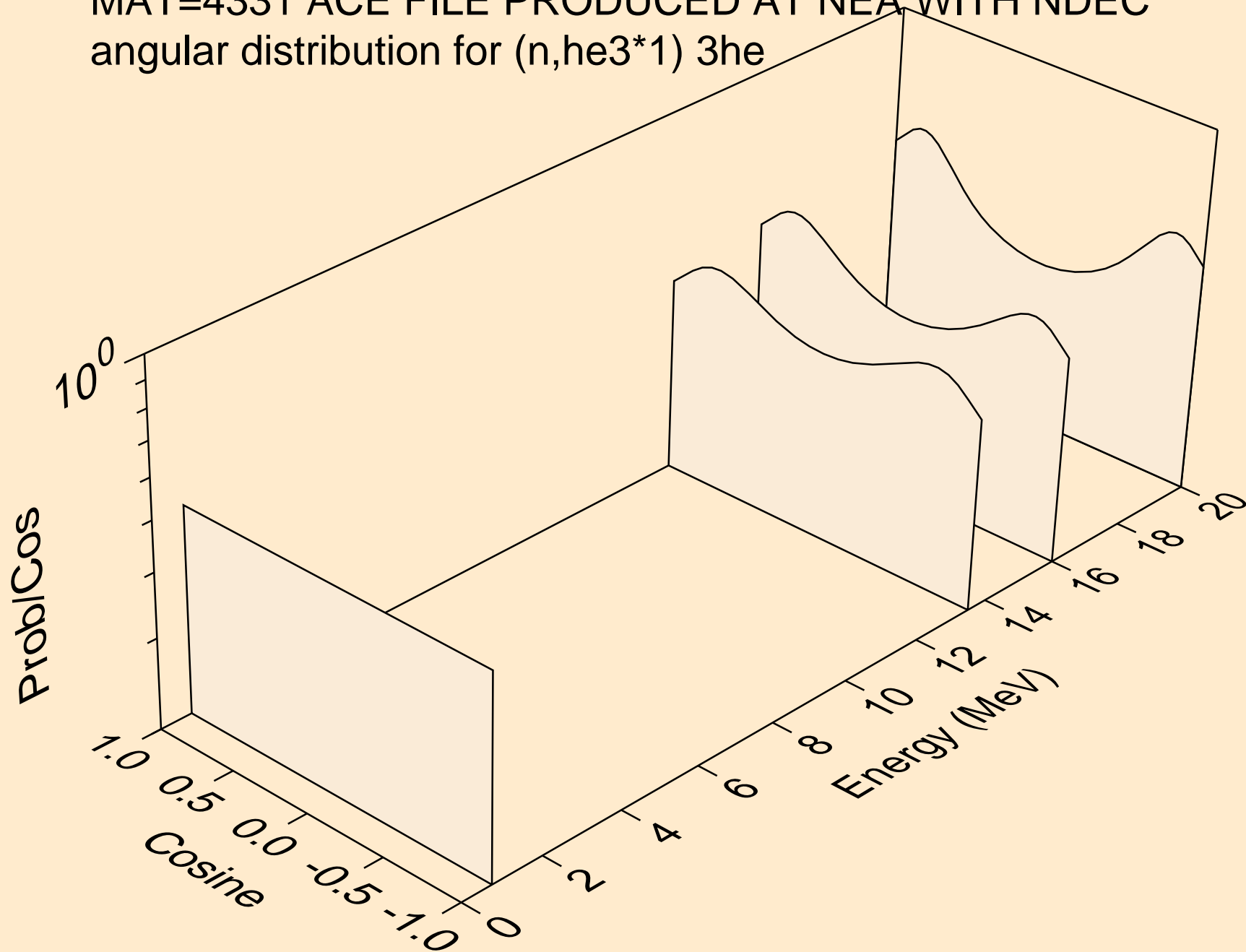

MAT=4331 ACE FILE PRODUCED AT NEA WITH NDEC
angular distribution for (n,he3*2) 3he

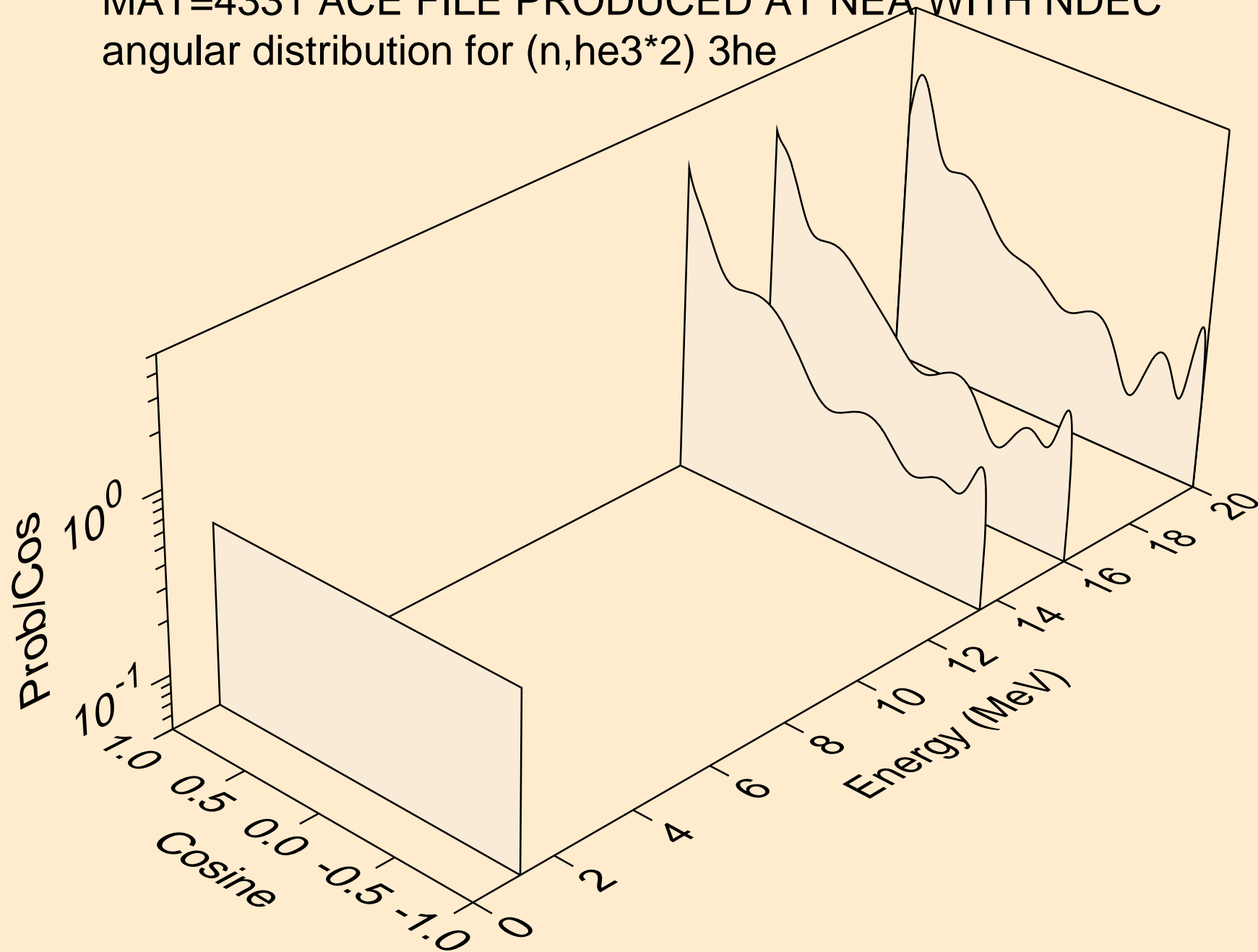

MAT=4331 ACE FILE PRODUCED AT NEA WITH NDEC
angular distribution for (n,he3*3) 3he

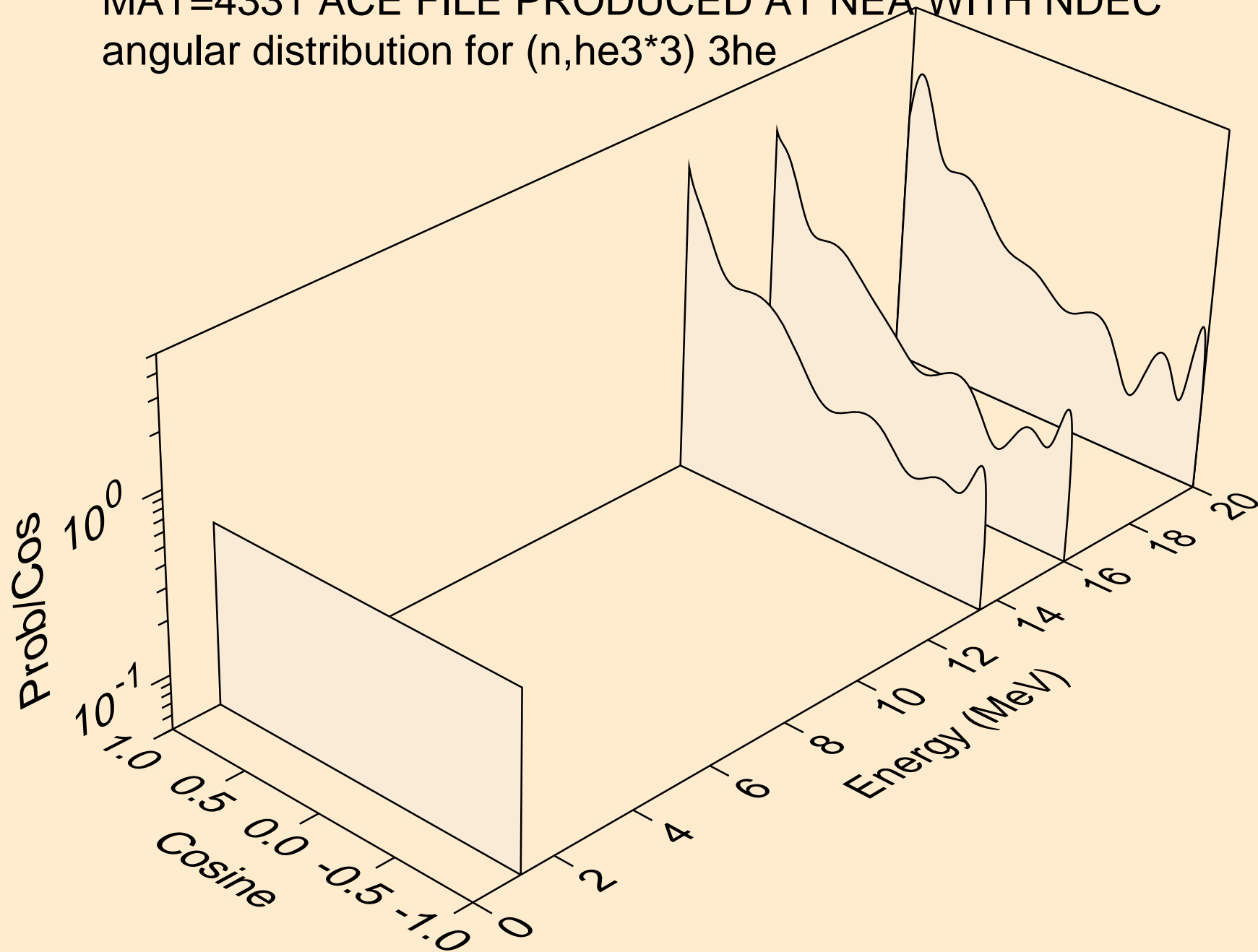

MAT=4331 ACE FILE PRODUCED AT NEA WITH NDEC
angular distribution for (n,he3*4) 3he

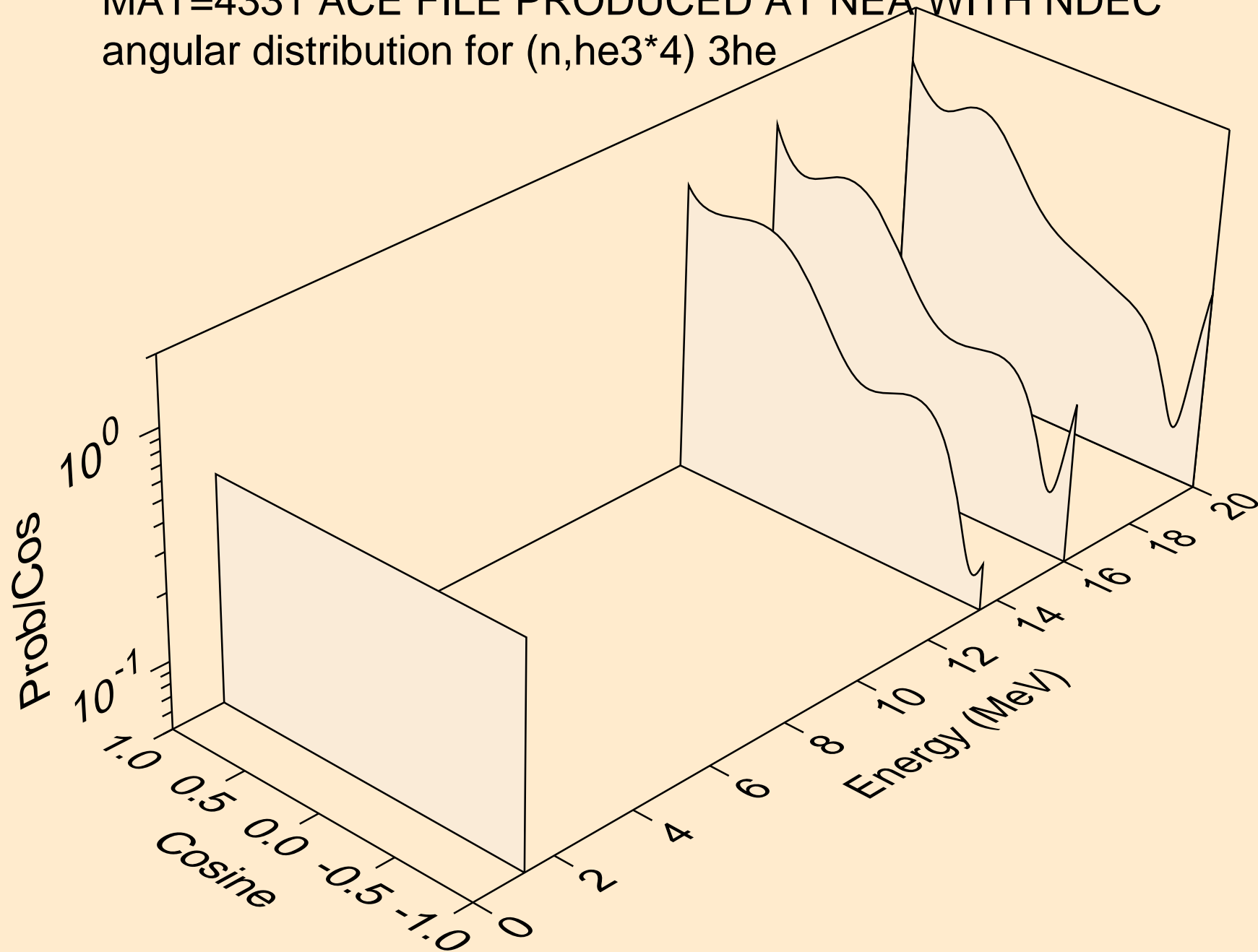

MAT=4331 ACE FILE PRODUCED AT NEA WITH NDEC
angular distribution for (n,he3*5) 3he

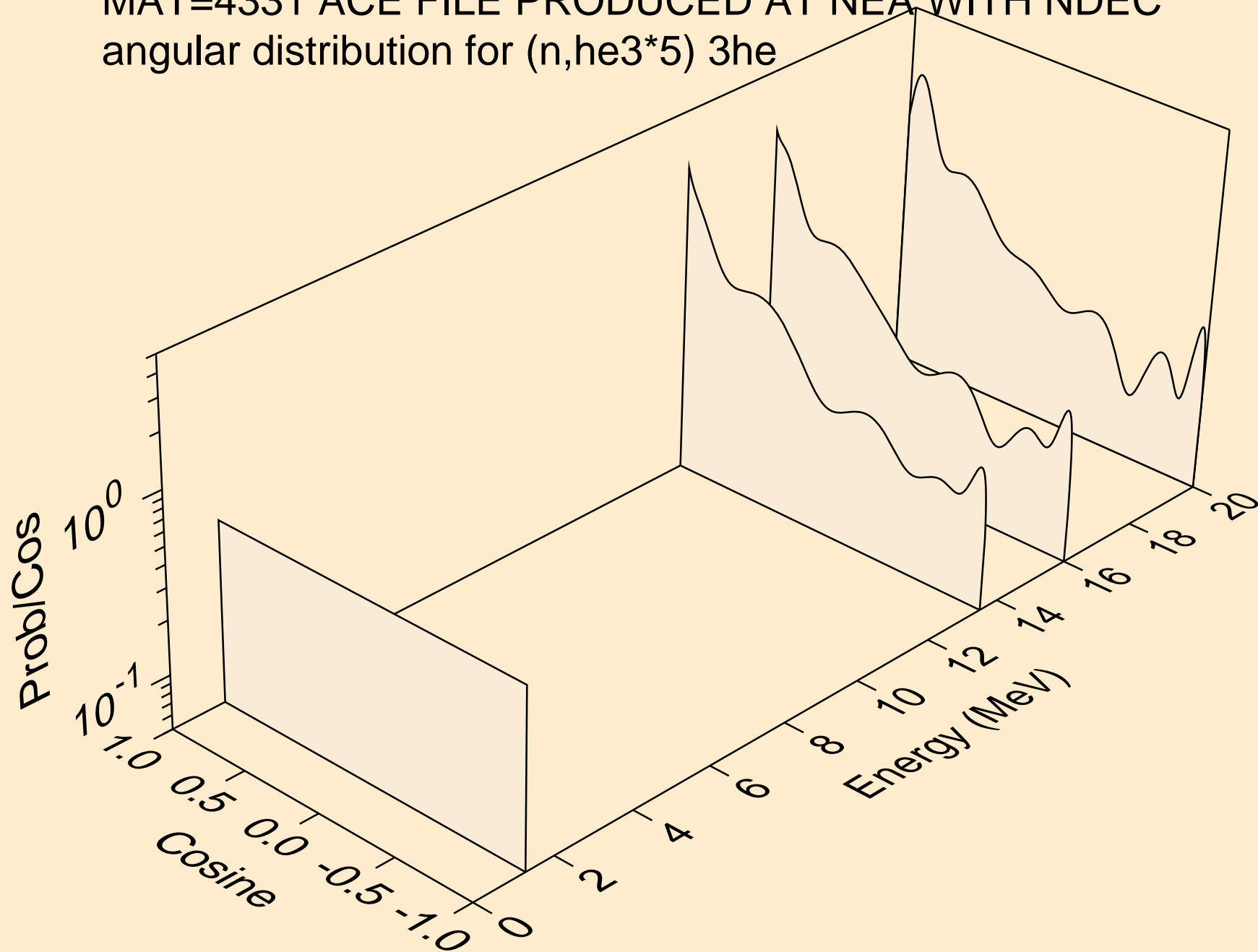

MAT=4331 ACE FILE PRODUCED AT NEA WITH NDEC
he3s from (n,he3*c)

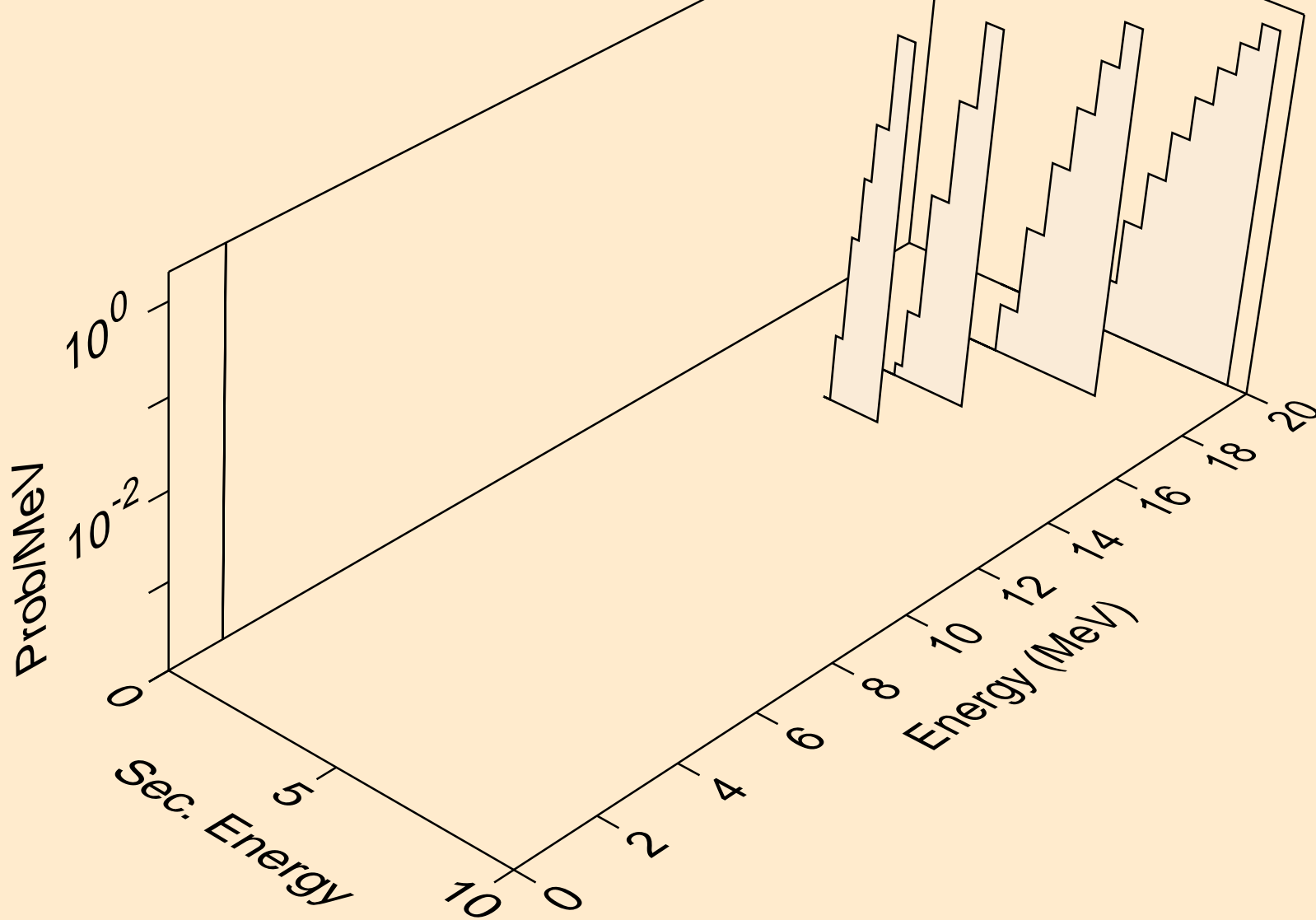

MAT=4331 ACE FILE PRODUCED AT NEA WITH NDEC
alphas from (n,x)

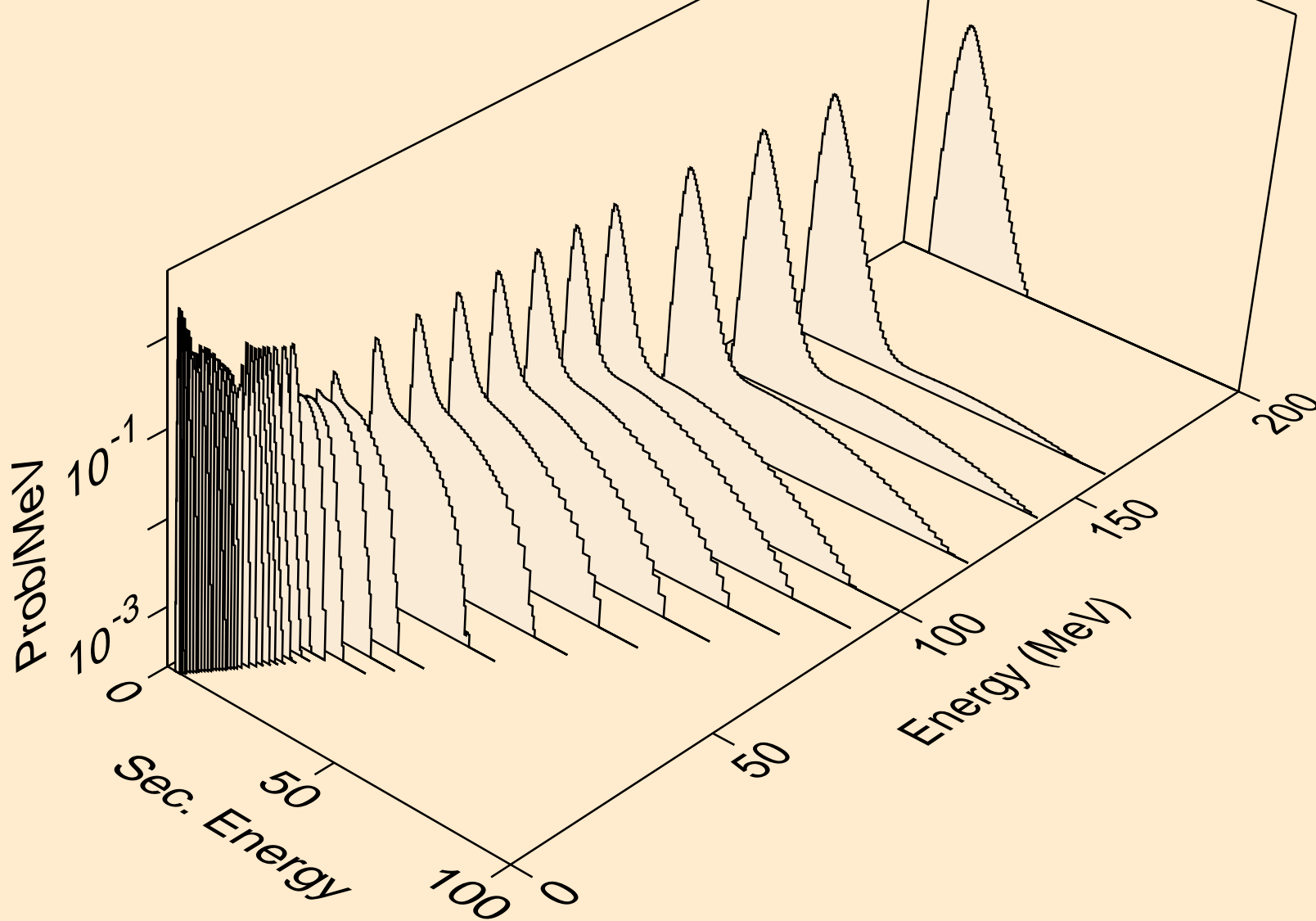

MAT=4331 ACE FILE PRODUCED AT NEA WITH NDEC
alphas from (n,n*)a

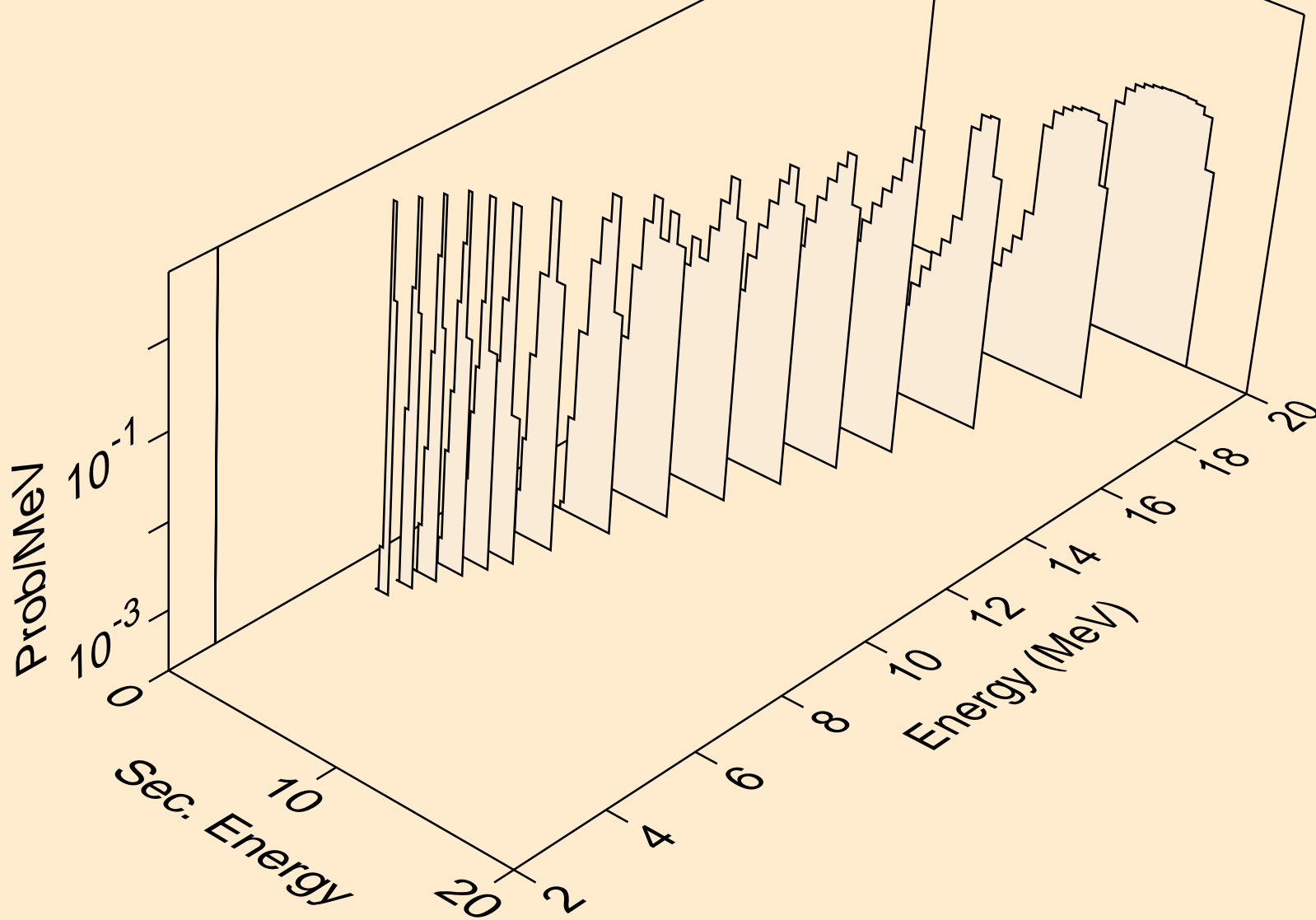

MAT=4331 ACE FILE PRODUCED AT NEA WITH NDEC
alphas from (n,2n)a

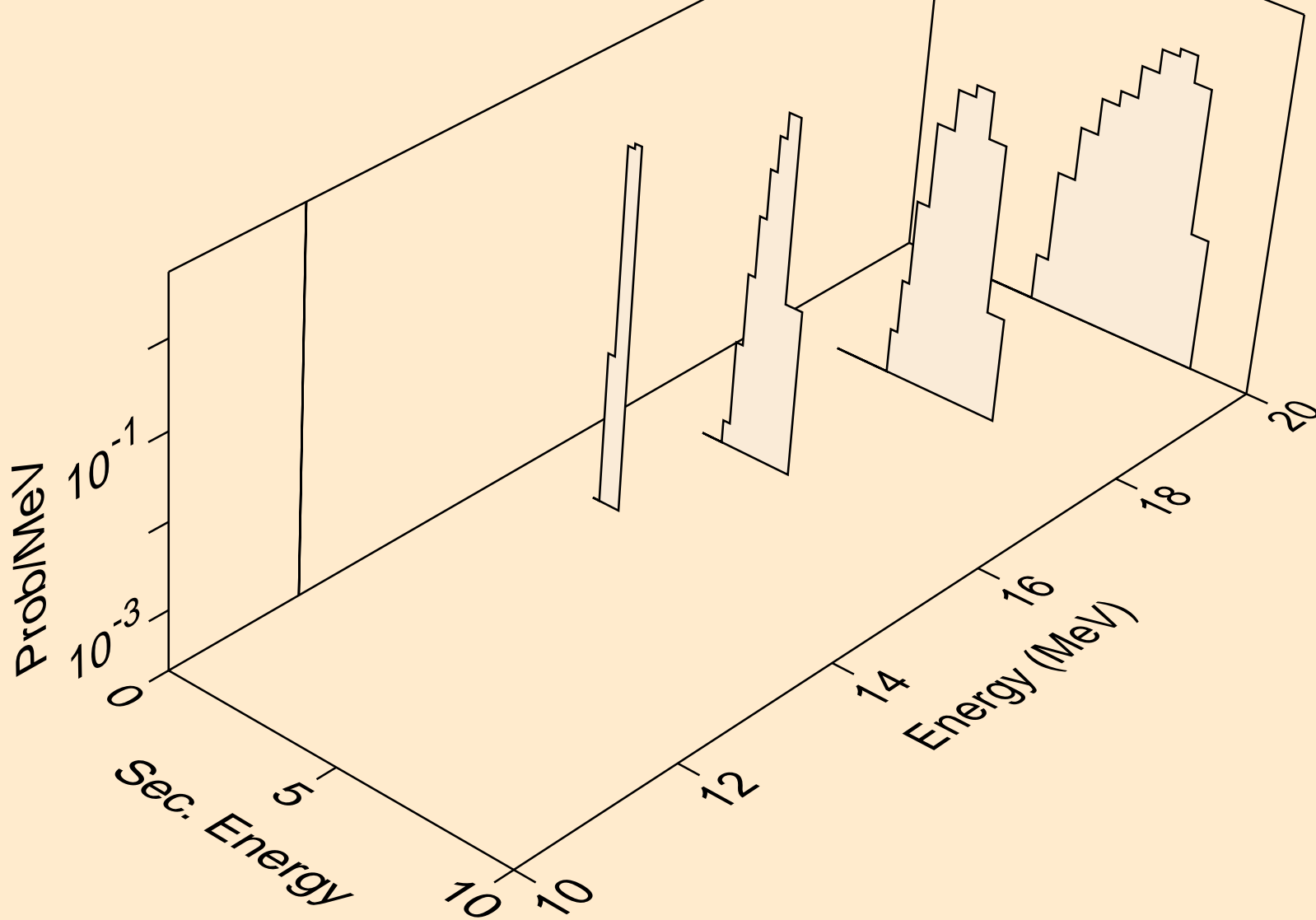

MAT=4331 ACE FILE PRODUCED AT NEA WITH NDEC
alphas from (n,2a)

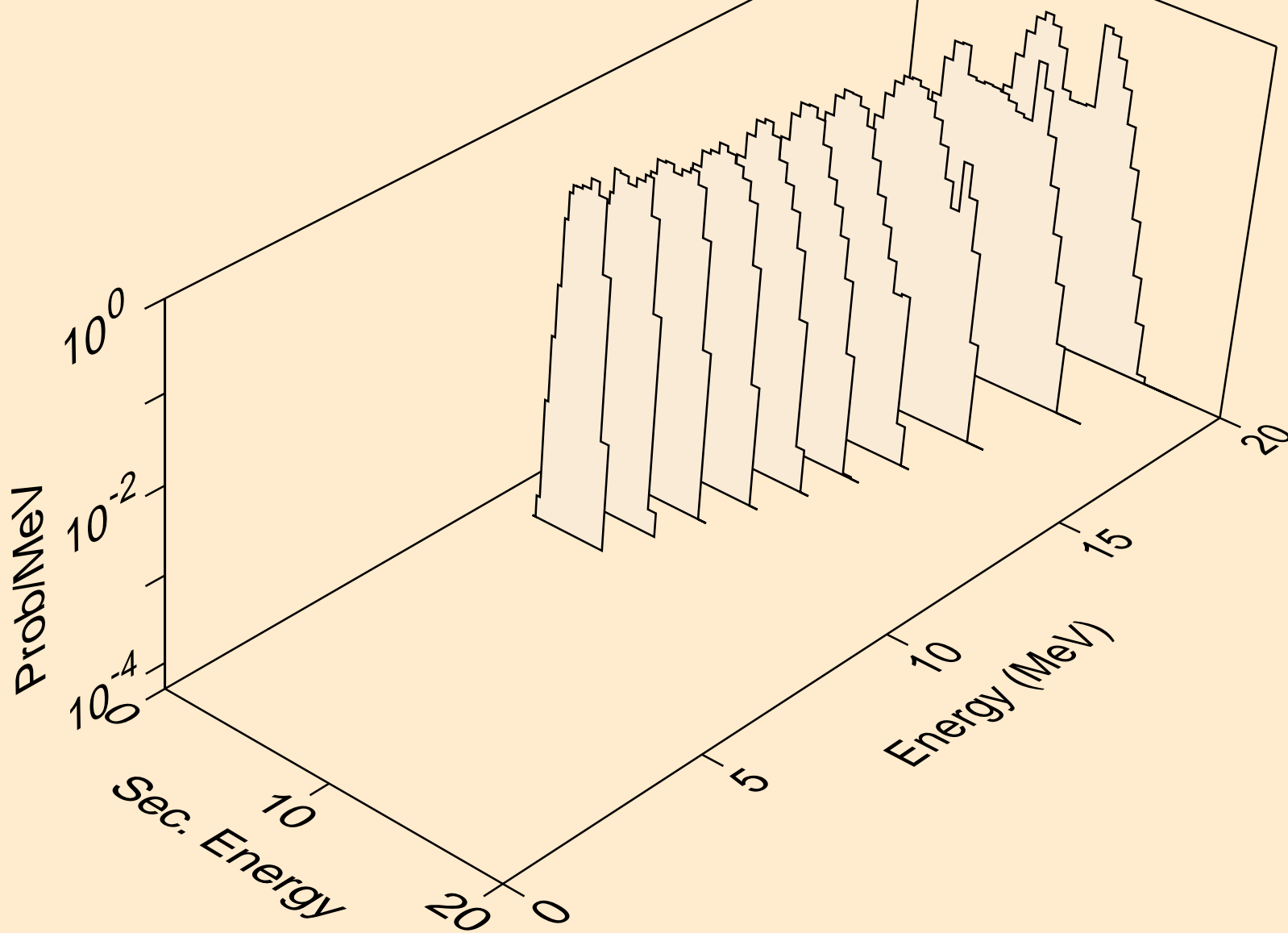

MAT=4331 ACE FILE PRODUCED AT NEA WITH NDEC
alphas from (n,pa)

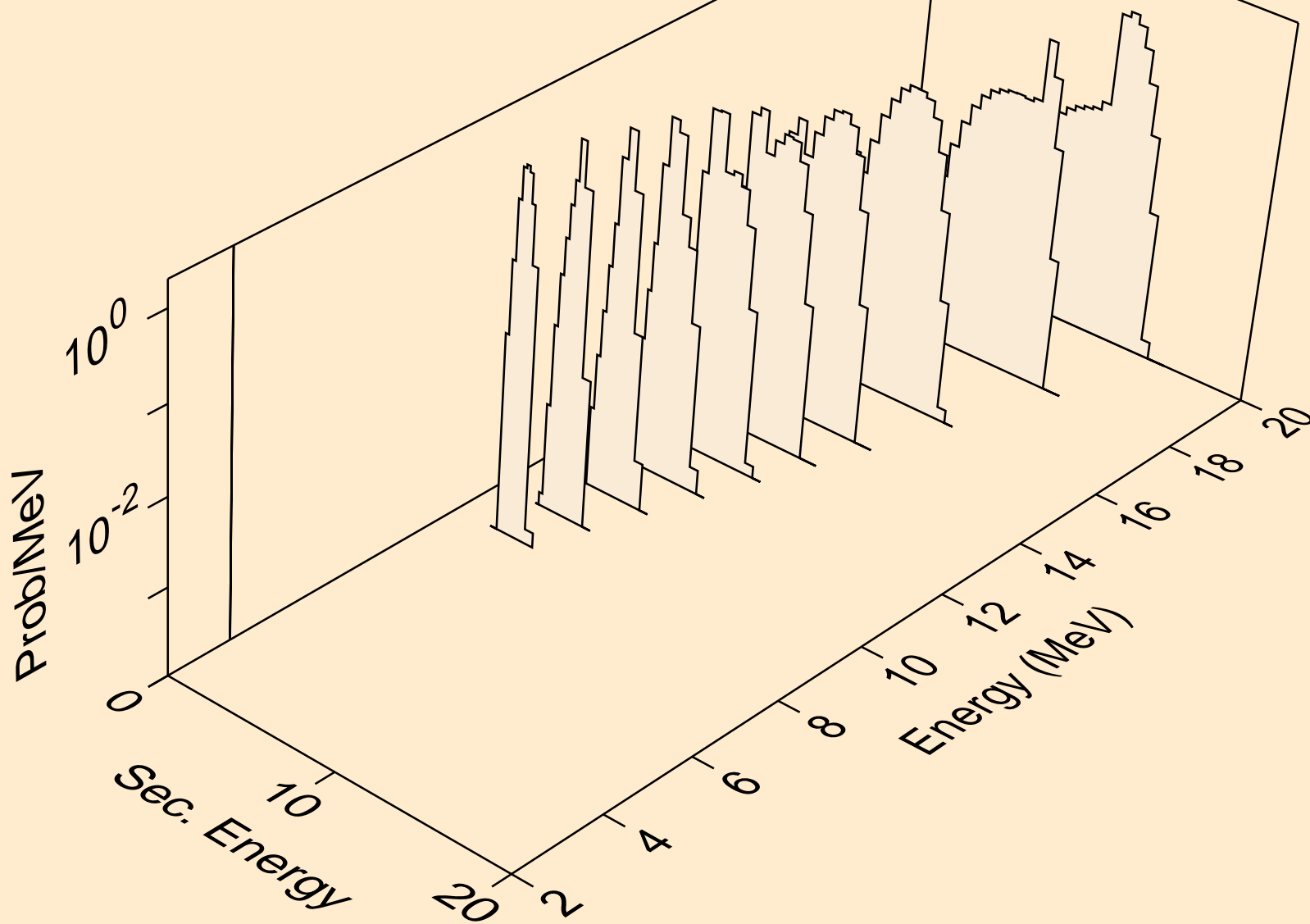

MAT=4331 ACE FILE PRODUCED AT NEA WITH NDEC
angular distribution for (n,a*0) alpha

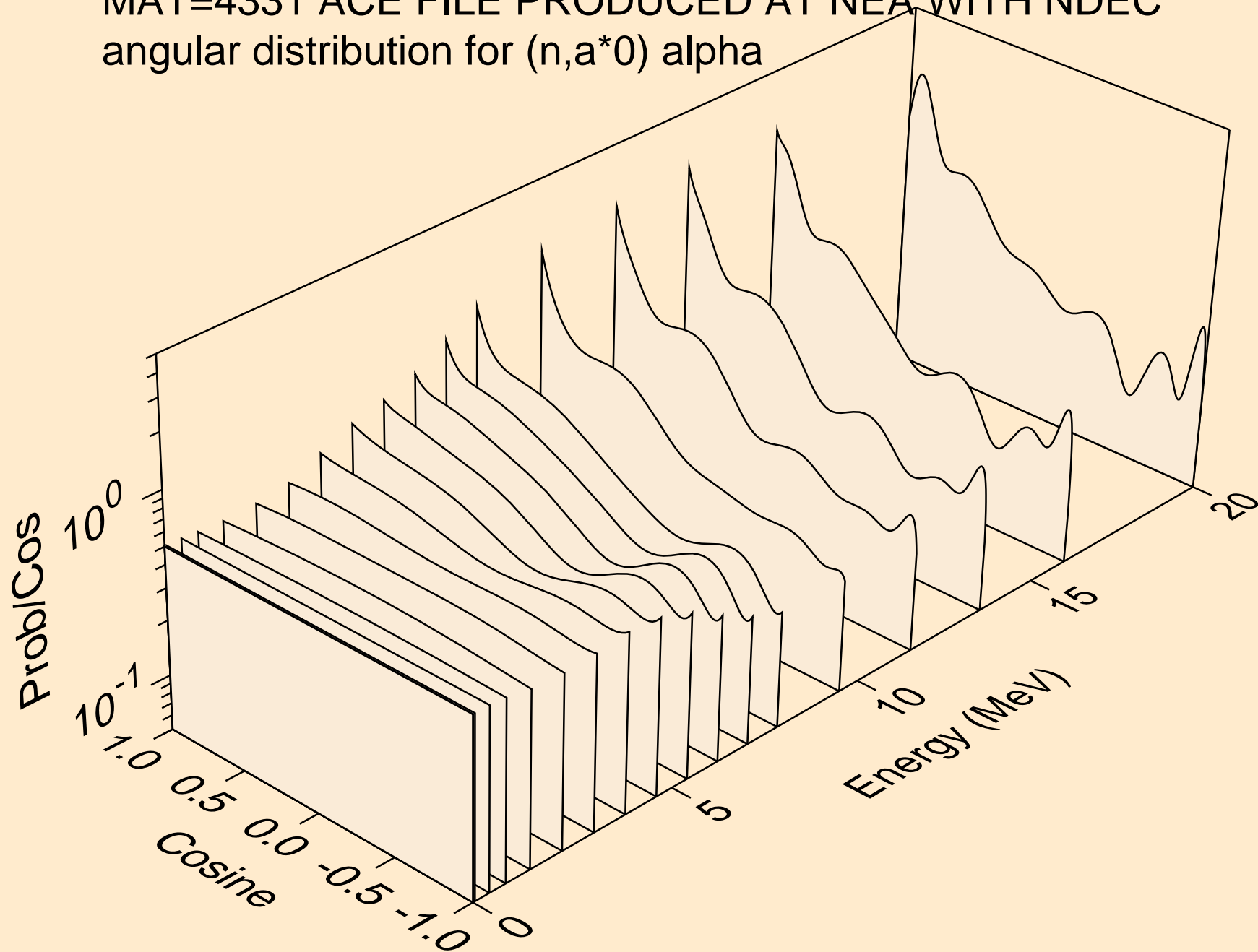

MAT=4331 ACE FILE PRODUCED AT NEA WITH NDEC
angular distribution for (n,a*1) alpha

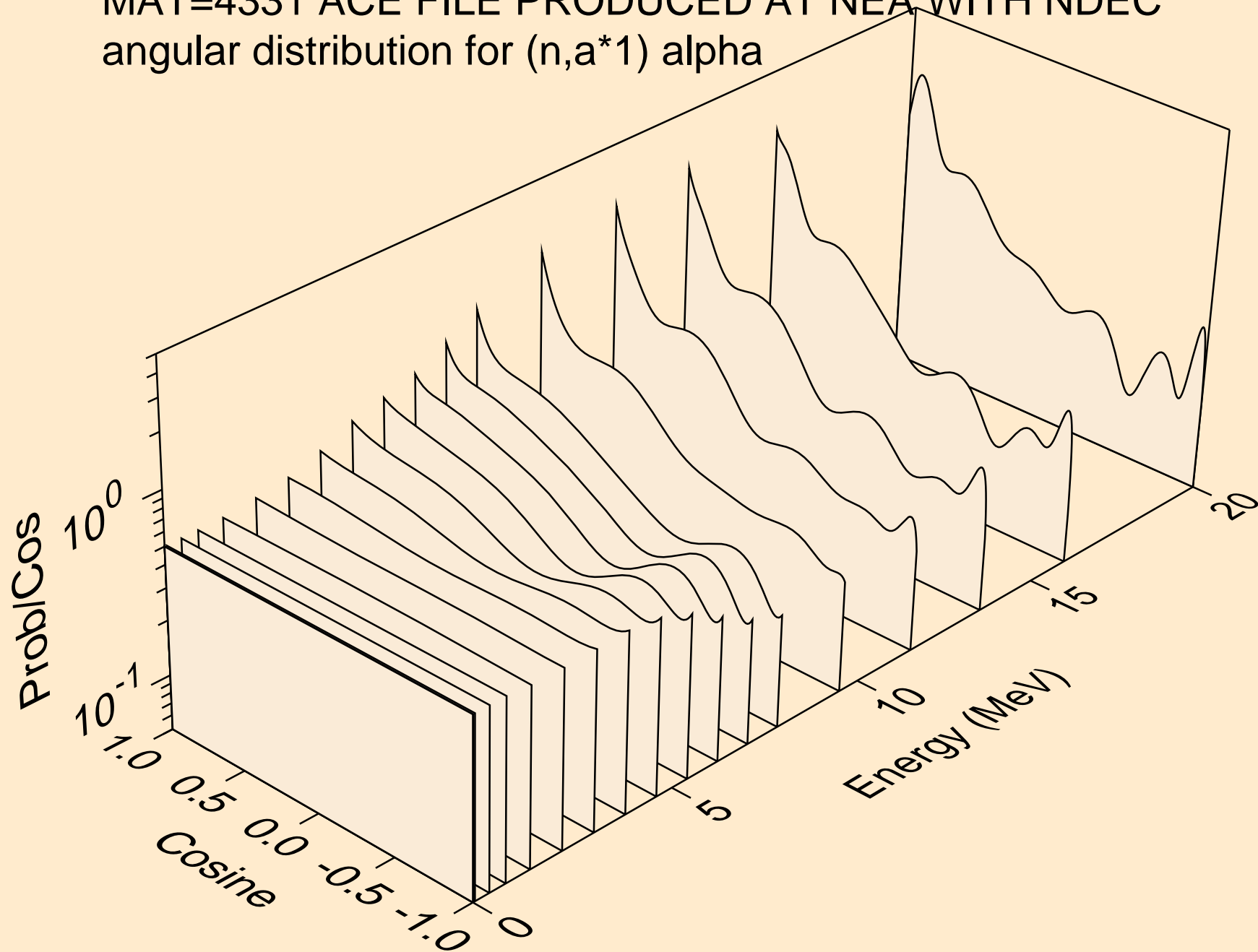

MAT=4331 ACE FILE PRODUCED AT NEA WITH NDEC
angular distribution for (n,a*2) alpha

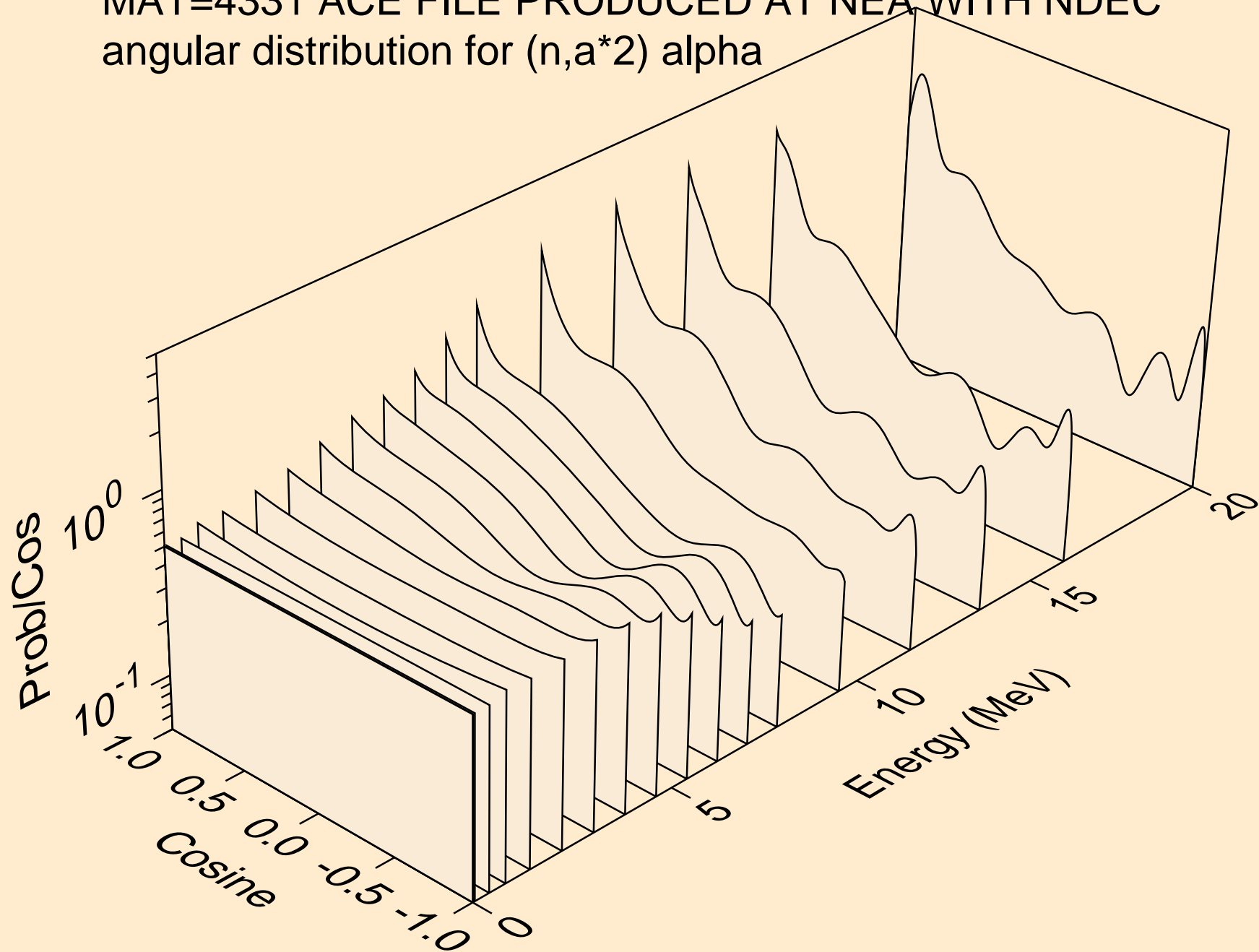

MAT=4331 ACE FILE PRODUCED AT NEA WITH NDEC
angular distribution for (n,a*3) alpha

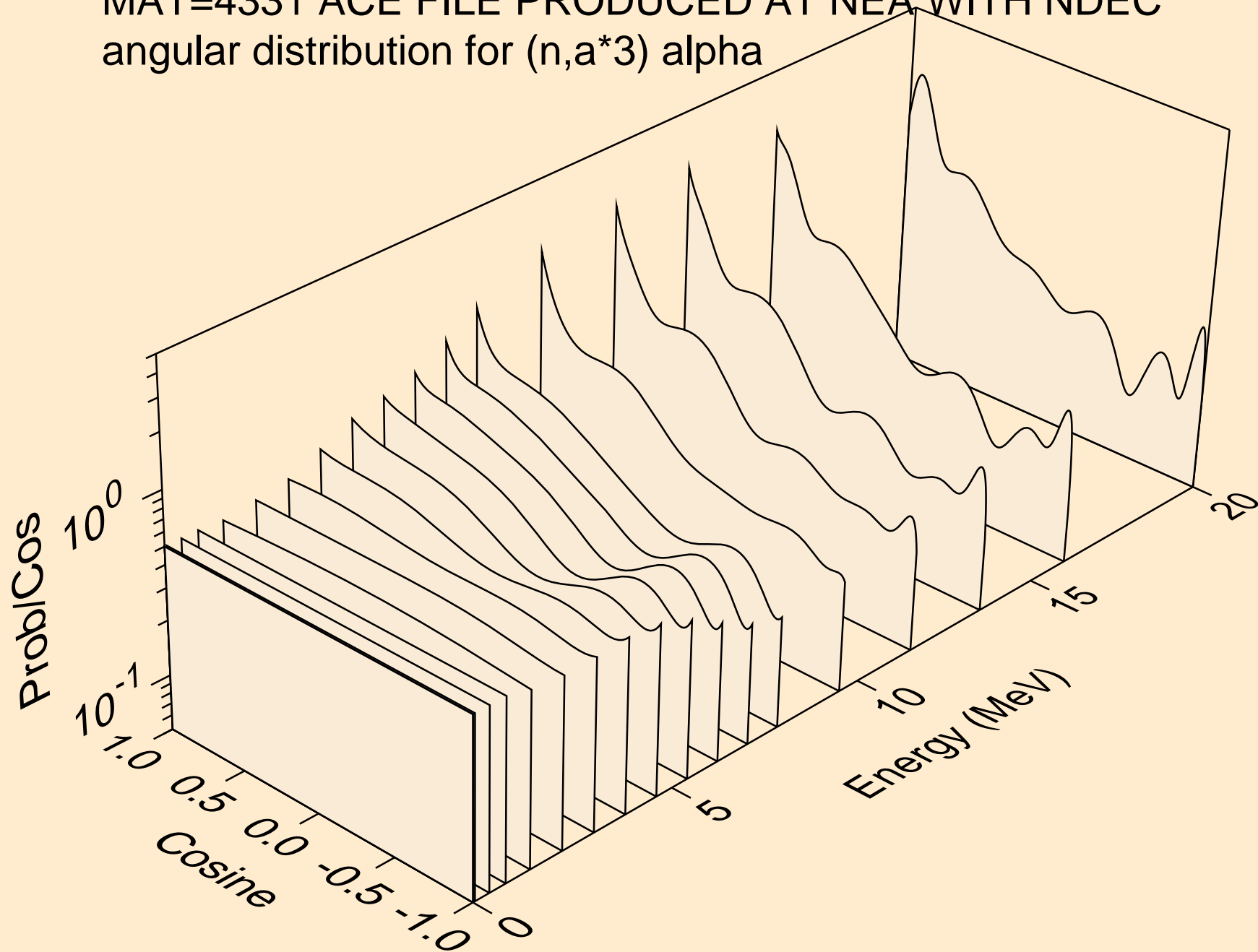

MAT=4331 ACE FILE PRODUCED AT NEA WITH NDEC
angular distribution for (n,a*4) alpha

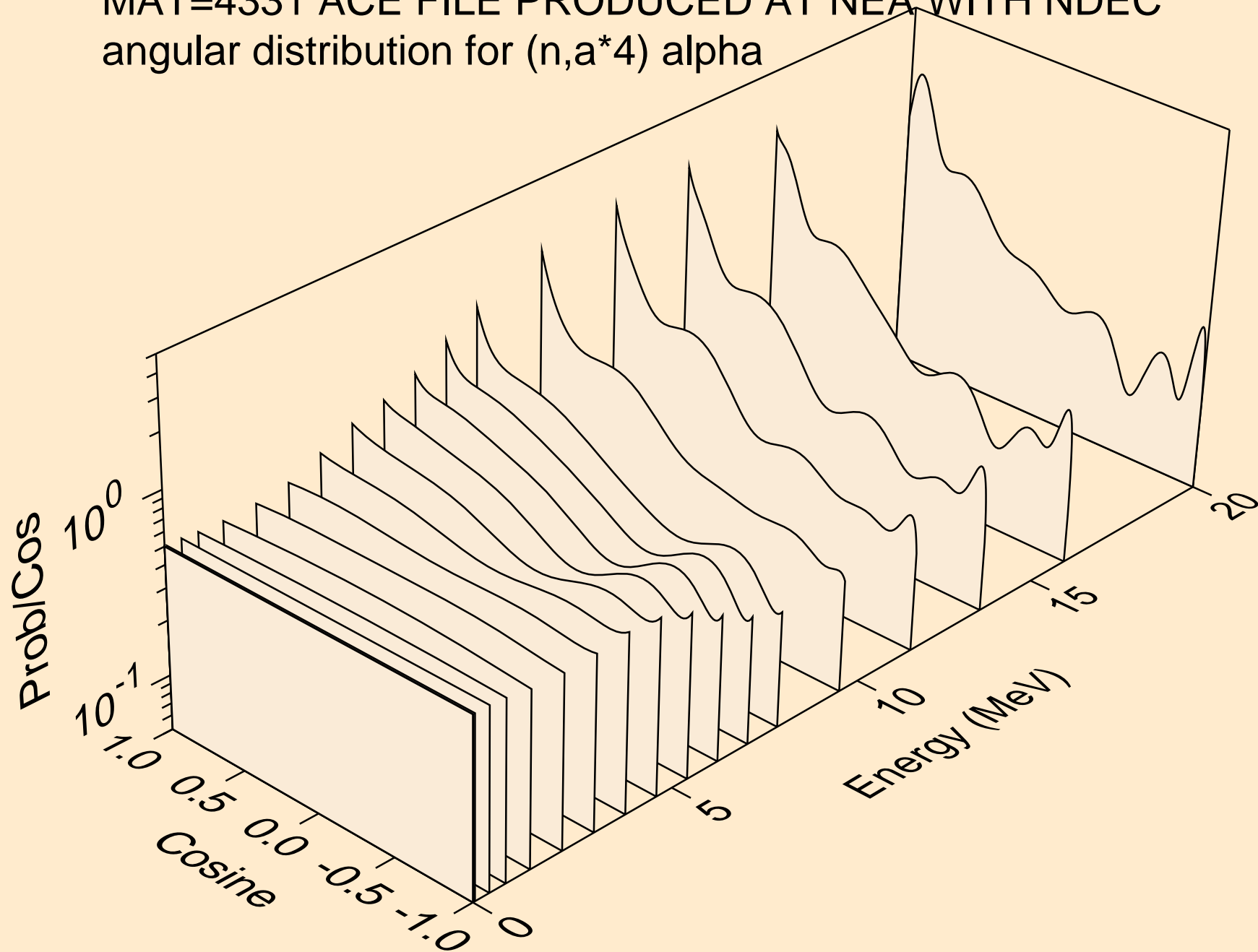

MAT=4331 ACE FILE PRODUCED AT NEA WITH NDEC
angular distribution for (n,a*5) alpha

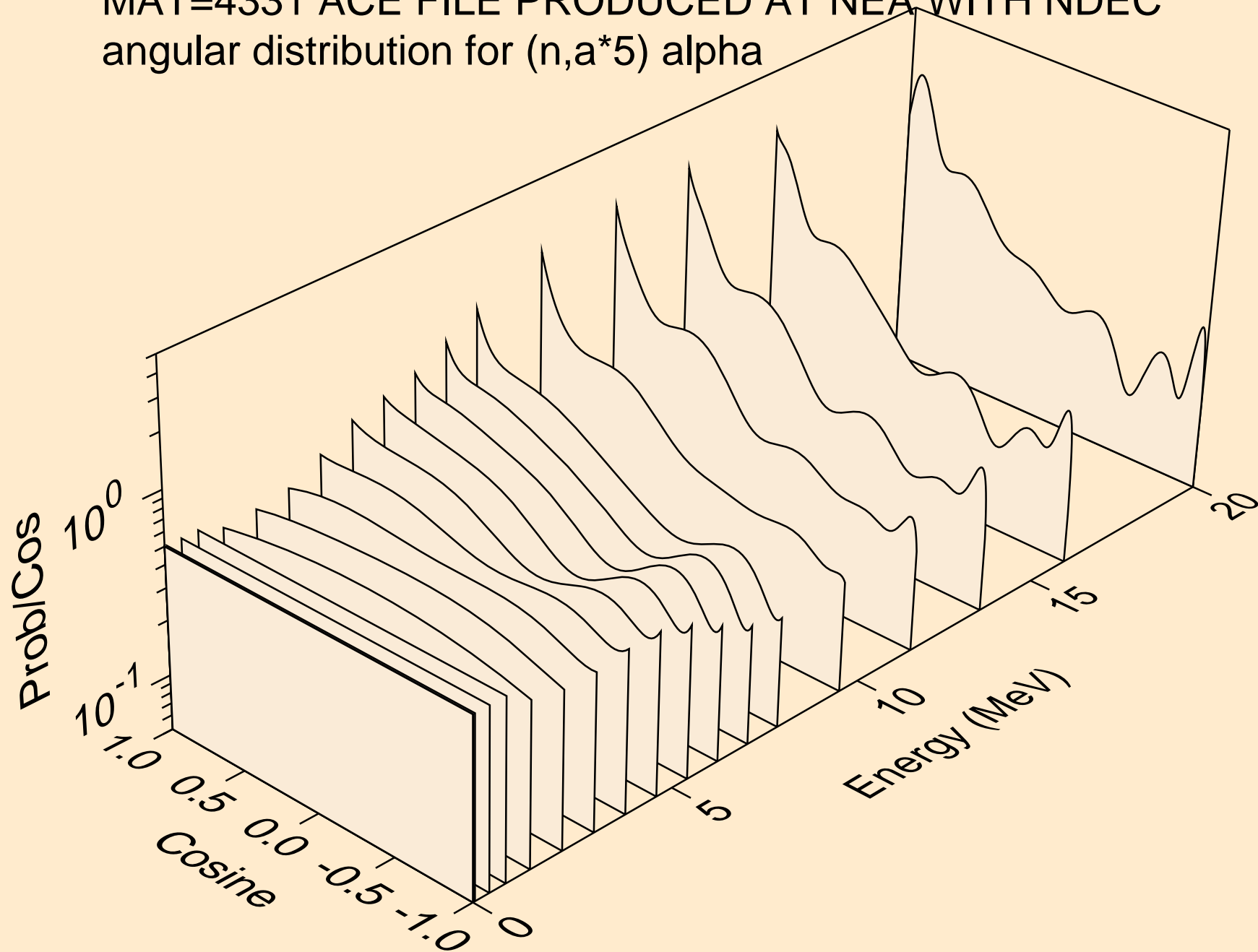

MAT=4331 ACE FILE PRODUCED AT NEA WITH NDEC
angular distribution for (n,a*6) alpha

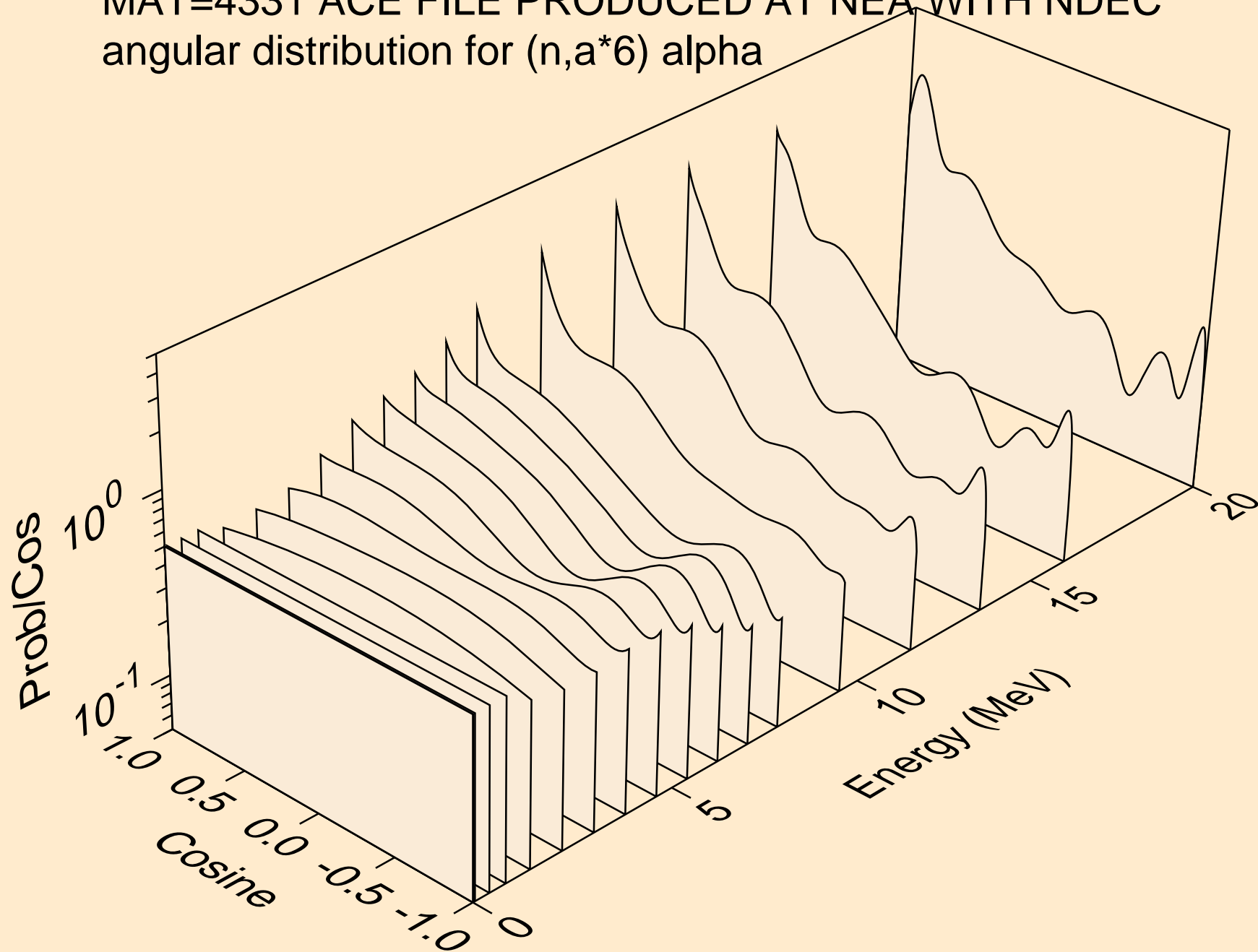

MAT=4331 ACE FILE PRODUCED AT NEA WITH NDEC
angular distribution for (n,a*7) alpha

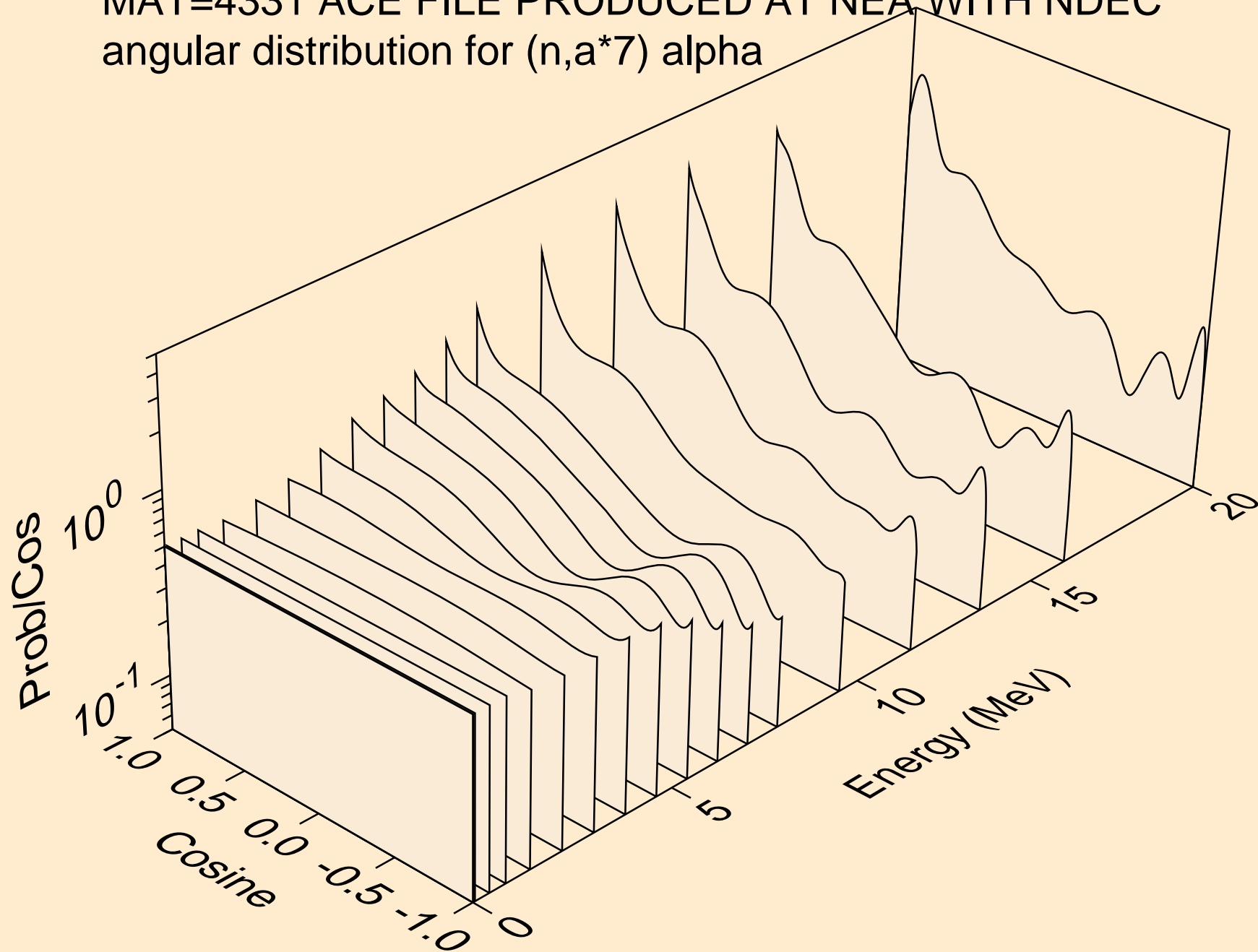

MAT=4331 ACE FILE PRODUCED AT NEA WITH NDEC
angular distribution for (n,a*8) alpha

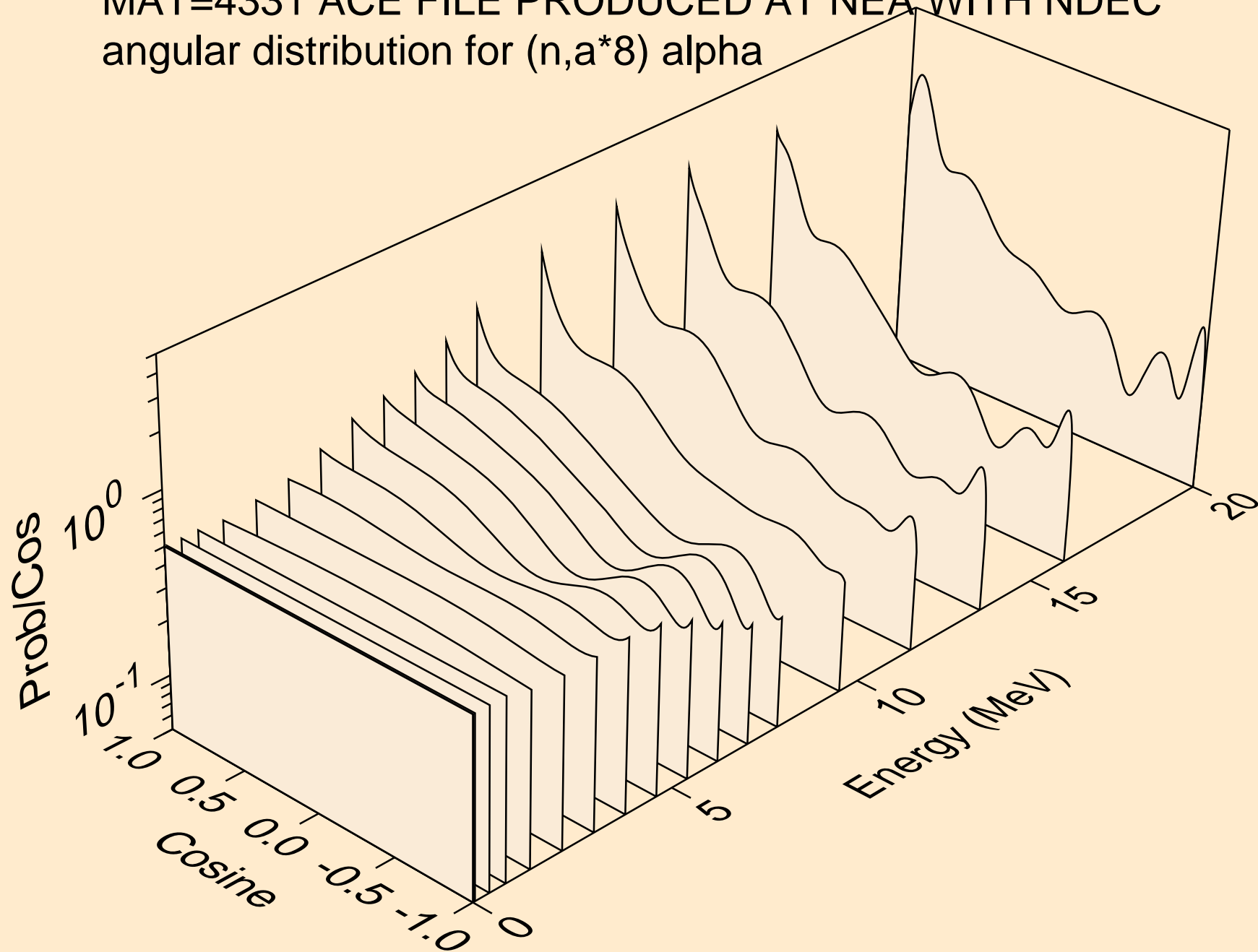

MAT=4331 ACE FILE PRODUCED AT NEA WITH NDEC
angular distribution for (n,a*9) alpha

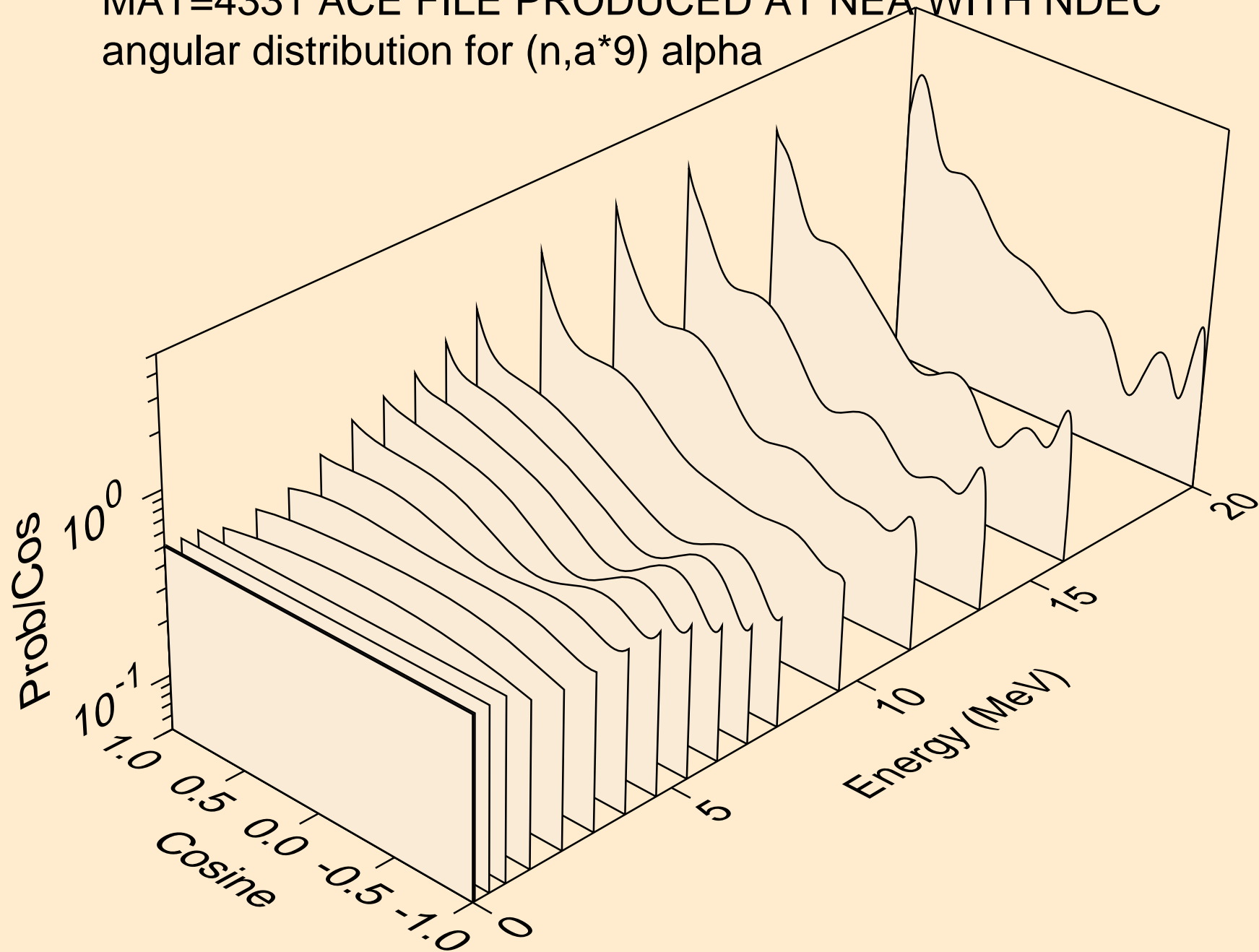

MAT=4331 ACE FILE PRODUCED AT NEA WITH NDEC
angular distribution for (n,a*10) alpha

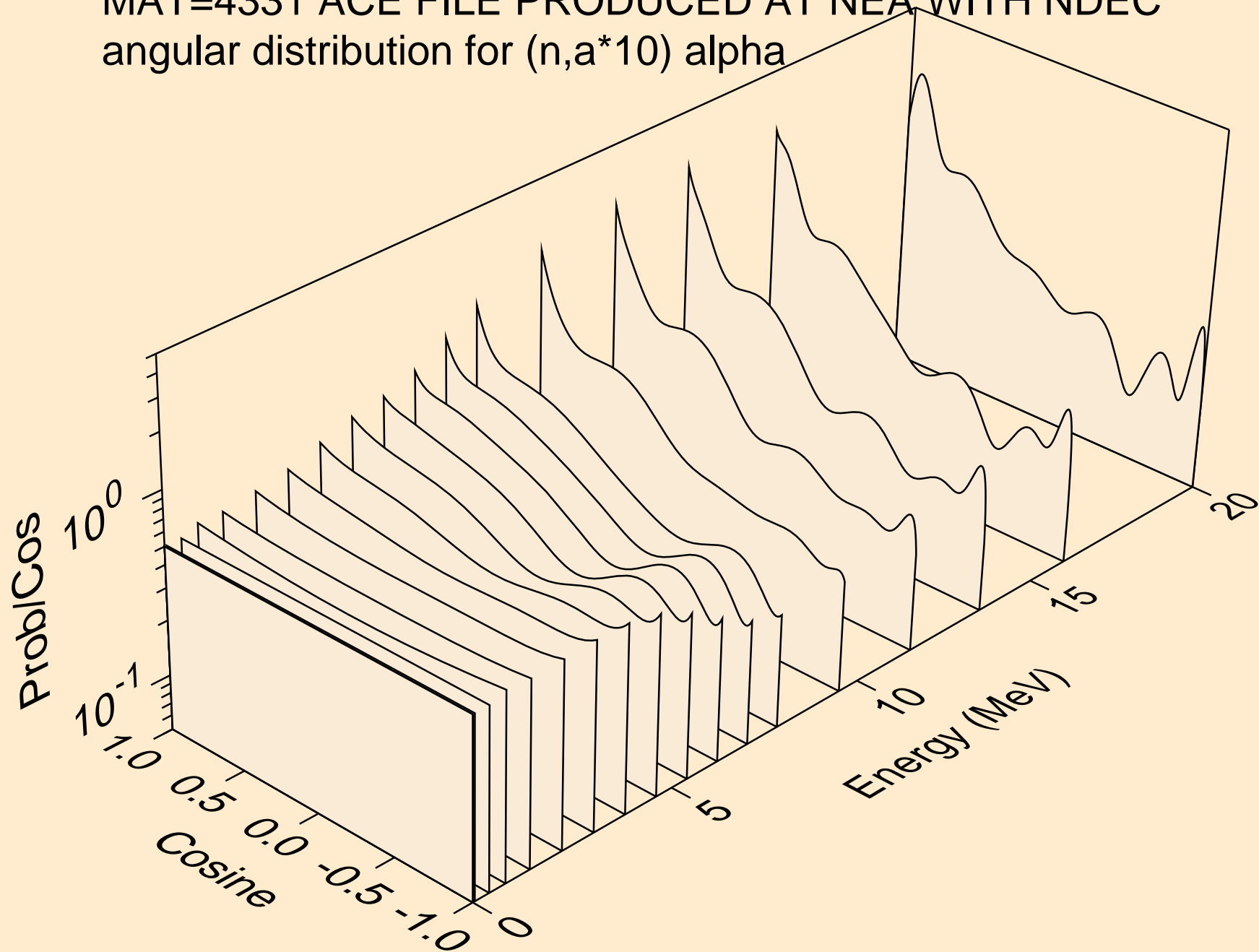

MAT=4331 ACE FILE PRODUCED AT NEA WITH NDEC
alphas from (n,a*c)

