

CONFIDENTIAL  
N° 1000 000 000 R.V.P.  
FRANCE

NEA/CSNI/R(94)8  
RESTRICTED

OECD

NEA

**PROCEEDINGS OF THE CSNI  
SYMPOSIUM ON THE SAFETY OF THE  
NUCLEAR FUEL CYCLE**

*Hosted by*

***The Belgian Nuclear Society***

***3rd-4th June, 1993  
Brussels, Belgium***



**COMMITTEE ON THE SAFETY OF NUCLEAR INSTALLATIONS  
OECD NUCLEAR ENERGY AGENCY**

*Le Seine St. Germain - 12, Boulevard des Iles,  
F-92130 Issy-les-Moulineaux*

*Tel: (33-1) 45 24 82 00 Fax: (33-1) 45 24 11 10*

*Electronic mail: NEA@FRNEAB51*

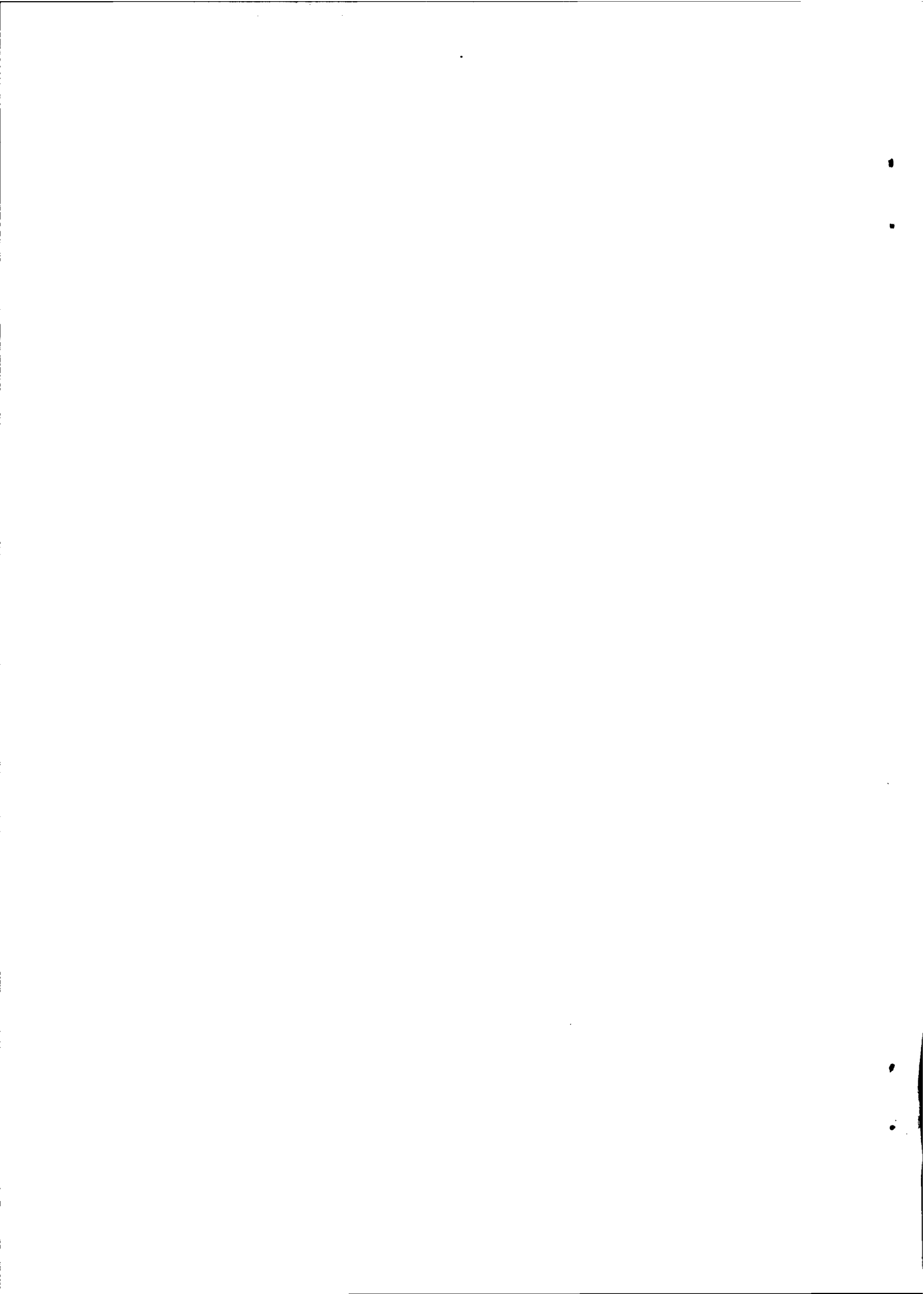

ORGANISATION FOR ECONOMIC  
CO-OPERATION AND DEVELOPMENT

NUCLEAR SAFETY DIVISION

STEERING COMMITTEE FOR  
NUCLEAR SAFETY

RESTRICTED

Paris, drafted: 6-January-94  
OLIS: 05-Jul-1994  
dist.: 08-Jul-1994

NEA/CSNI/R(94)8

Or. Eng.

COMMITTEE ON THE SAFETY OF NUCLEAR INSTALLATIONS

WORKING GROUP ON FUEL CYCLE SAFETY

PROCEEDINGS OF THE CSNI SYMPOSIUM ON  
THE SAFETY OF THE NUCLEAR FUEL CYCLE

Held in Paris, France  
25th-27th April, 1994

015026

FOR TECHNICAL REASONS, THIS DOCUMENT IS NOT AVAILABLE ON OLIS.

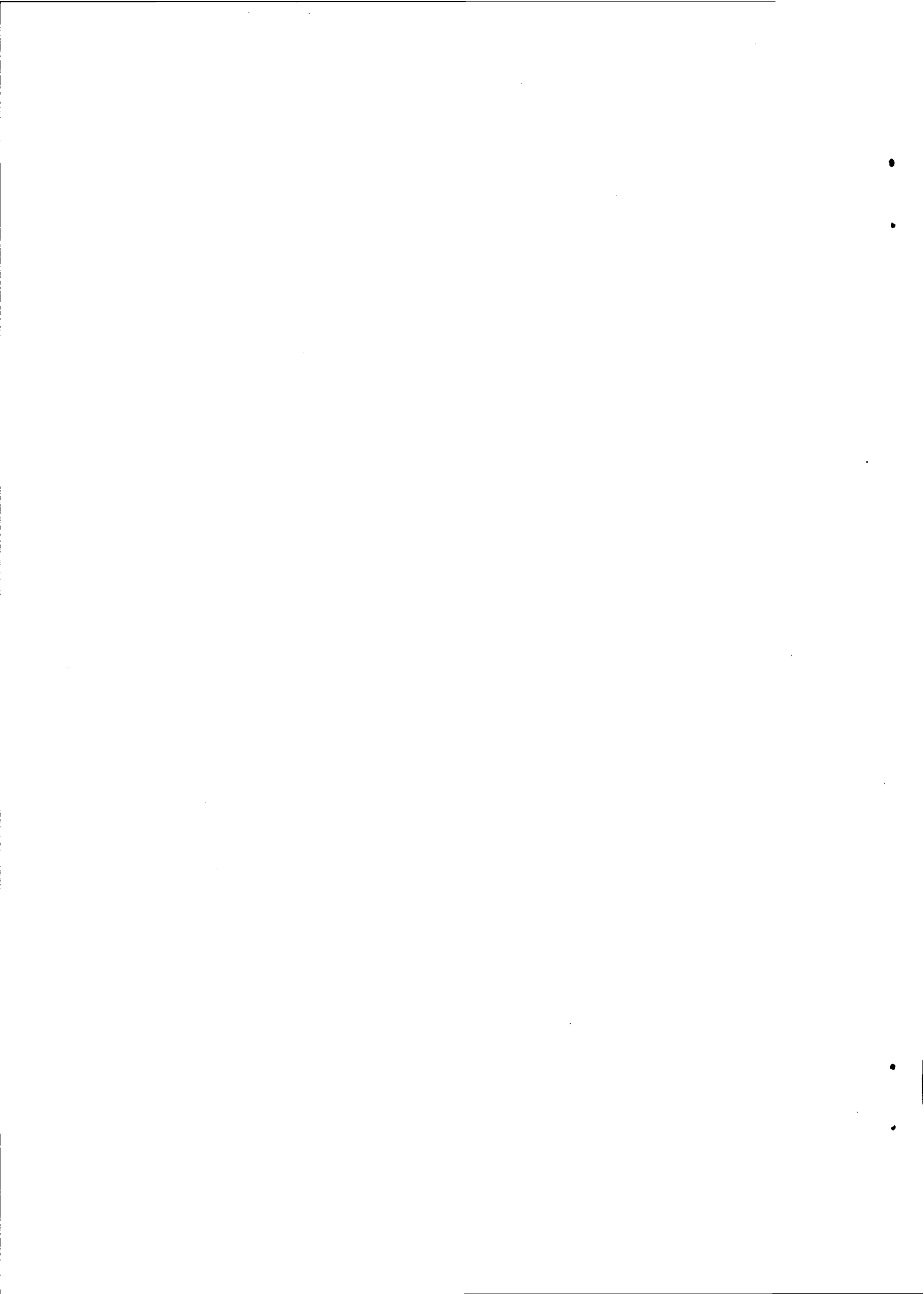



## COMMITTEE ON THE SAFETY OF NUCLEAR INSTALLATIONS

The Committee on the Safety of Nuclear Installations (CSNI) of the OECD Nuclear Energy Agency (NEA), is an international committee made up of senior scientists and engineers. It was set up in 1973 to develop and coordinate the activities of the Nuclear Energy Agency concerning the technical aspects of the design, construction and operation of nuclear installations insofar as they affect the safety of such installations. The Committee's purpose is to foster international cooperation in nuclear safety among the OECD Member countries.

The CSNI constitutes a forum for the exchange of technical information and for collaboration between organizations which can contribute, from their respective backgrounds in research, development, engineering or régulation, to these activities and to the definition of its programme of work. It also reviews the state of knowledge on selected topics of nuclear safety technology and safety assessment, including operating experience. It initiates and conducts programmes identified by these reviews and assessments in order to overcome discrepancies, develop improvements and reach international consensus on technical issues of common interest. It promotes the coordination of work in different Member Countries including the establishment of cooperative research projects and results to participating organizations. Full use is also made of traditional methods of cooperation, such as information exchanges, establishment of working groups, and organization of conferences and specialist meetings.

The greater part of the CSNI's current programme of work is concerned with safety technology of water reactors. The principal areas covered are operating experience and the human factor, reactor coolant system behaviour, various aspects of reactor component integrity, the phenomenology of radioactive releases in reactor accidents and their confinement, containment performance, risk assessment, and severe accidents. The Committee also studies the safety of the nuclear fuel cycle, conducts periodic surveys of the reactor safety research programmes and operates an international mechanism for exchanging reports on safety related nuclear power plant accidents.

In implementing its programme, the CSNI establishes cooperative mechanisms with NEA's Committee of Nuclear Regulatory Activities (CNRA), responsible for the activities of the Agency concerning the regulation, licensing and inspection of nuclear installations with regards to safety. It also cooperates with NEA's Committee on Radiation Protection and Public Health and NEA's Radioactive Waste Management Committee on matters of common interest.

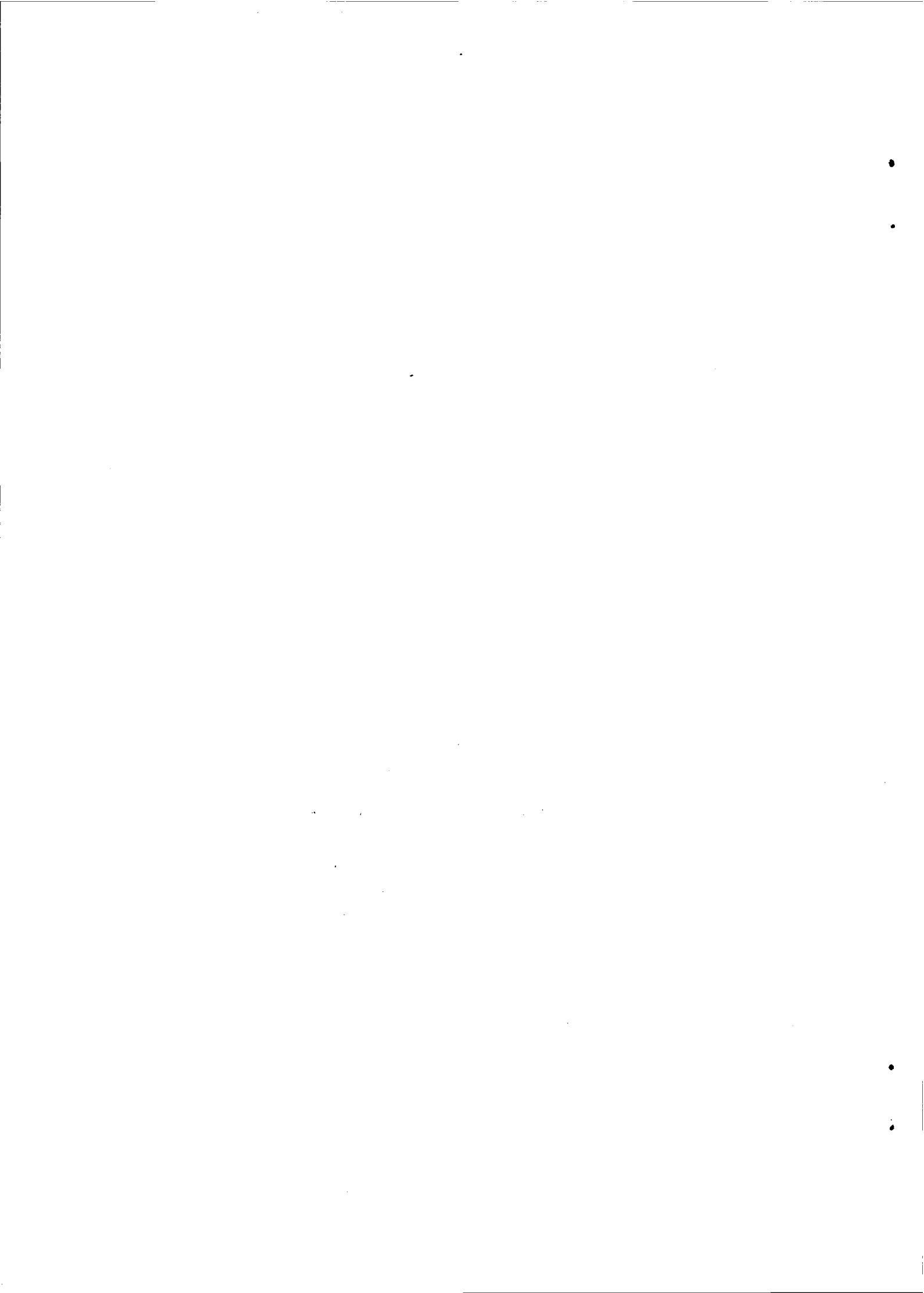

## FINAL PROGRAMME

**Thursday, June 3rd**

**9:00 Introduction:** Dr. K.B. Stadie, Deputy Director  
Safety and Regulation, OECD Nuclear Energy Agency

**9:15 Session 1:** Presentation of OECD-NEA Report

Co-ordination: Dr. M.L. Brown, AEA  
Dr. L.H. Baetslé, SCK/CEN

L.H. Baetslé, SCK/CEN, Belgium	Scope of the book, introduction to the fuel cycle
L.G. Williams, NII, United Kingdom	Safety philosophy of the fuel cycle facilities
Y. Naito, KAERI, Japan	Radiological safety
M. Kanamori, PNC, Japan	Specific Japanese safety issues
T. Viglasky, AECSB, Canada	} The front-end of the fuel cycle
H. Auchère, IPSN, France	
J. Tew, NII, United Kingdom	The back-end of the fuel cycle
H. Auchère, IPSN, France	Transport of nuclear materials, general safety issues (not included)
W. Thomas, GRS, Germany	Safety record of the fuel cycle facilities (not included)
M.L. Brown, AEA, United Kingdom	Conclusion, further activities

**14:00 Session 2:** Front-End of Fuel Cycle

Co-chair: Mr. P. Goldschmidt, Synatom  
Dr. G. Glattes, Uranerzbau

1. SAFETY OF URANIUM MINING OPERATIONS IN CANADA, T. Viglasky, Canada
2. HEALTH PHYSICS ASPECTS OF URANIUM MINING IN FRANCE, S. Bernhard, COGEMA, Bessines, France

3. SAFETY ASPECTS IN DECOMMISSIONING OF URANIUM MILL FACILITIES, J.L. Santiago, ENRESA, Spain
4. URENCO EXPERIENCE OF URANIUM ENRICHMENT BY CENTRIFUGATION, B.G. Dekker, URENCO, The Netherlands
5. SAFETY RECORDS OF THE URANIUM ENRICHMENT IN THE EURODIF FRENCH DIFFUSION PLANT, T. Charles, IPSN, France
6. DEVELOPMENT OF THE SILVA PROCESS, J.P. Pervès, A. Rosengard, CEA, France

18:00 Installation of the new BNS Executive Committee

**Friday, June 4th**

**9:00 Session 3: Fuel Fabrication**

Co-chair: Mr. G. Cornet, Belgonucléaire  
Mr. P. Chometon, Cogema

1. SOME CONCRETE SAFETY ASPECTS OF THE FUEL MANUFACTURING AT FBFC INTERNATIONAL, P. van Denhove, FBFC, Belgium
2. OPERATIONAL AND SAFETY ASPECTS OF MOX FUEL FABRICATION, J. van Vliet, Belgonucléaire, Belgium
3. THE FUTURE MELOX PLANT, DESIGN AND SAFETY ISSUES, B. Darbouret, IPSN, France (not included)
4. SAFETY RECORDS OF THE GERMAN FUEL FABRICATION FACILITIES, W. THOMAS, GRS, Germany
5. PRESENT STATUS OF THE HANAU MOX FUEL FABRICATION FACILITY WITH EMPHASIS ON THE SAFETY ISSUES, G. Brähler, Siemens KWU, Germany

**14:00 Session 4: Back-end of the Fuel Cycle**

Co-chair: Dr. G.H. Stevens, OECD-NEA  
Mr. J. Claes, Belgoprocess

1. SAFETY RECORD OF THE FRENCH REPROCESSING PLANTS, J.P. Mercier, IPSN, France

2. ENVIRONMENTAL SAFETY OF REPROCESSING - THE EXPERIENCE AT LA HAGUE, J. Simonnet, Cogema, France
3. THE THERMAL OXIDE REPROCESSING PLANT AT SELLAFIELD "State of the Art" Safety Analysis, J.B. Taylor, G.T. Sheppard, BNFL, United Kingdom
4. SAFETY ASSESSMENT OF PLANT MODIFICATIONS AND DECOMMISSIONING ON THE BNFL SITE, W.C. Mullineaux, BNFL, United Kingdom
5. THE VITRIFICATION OF HIGH LEVEL WASTES IN FRANCE FROM THE LAB TO THE INDUSTRIAL PLANTS, C.G. Sombret, CEA, France
6. SAFETY IN THE DESIGN AND OPERATION OF THE VITRIFICATION FACILITIES AT LA HAGUE, D. Martineau, IPSN, France

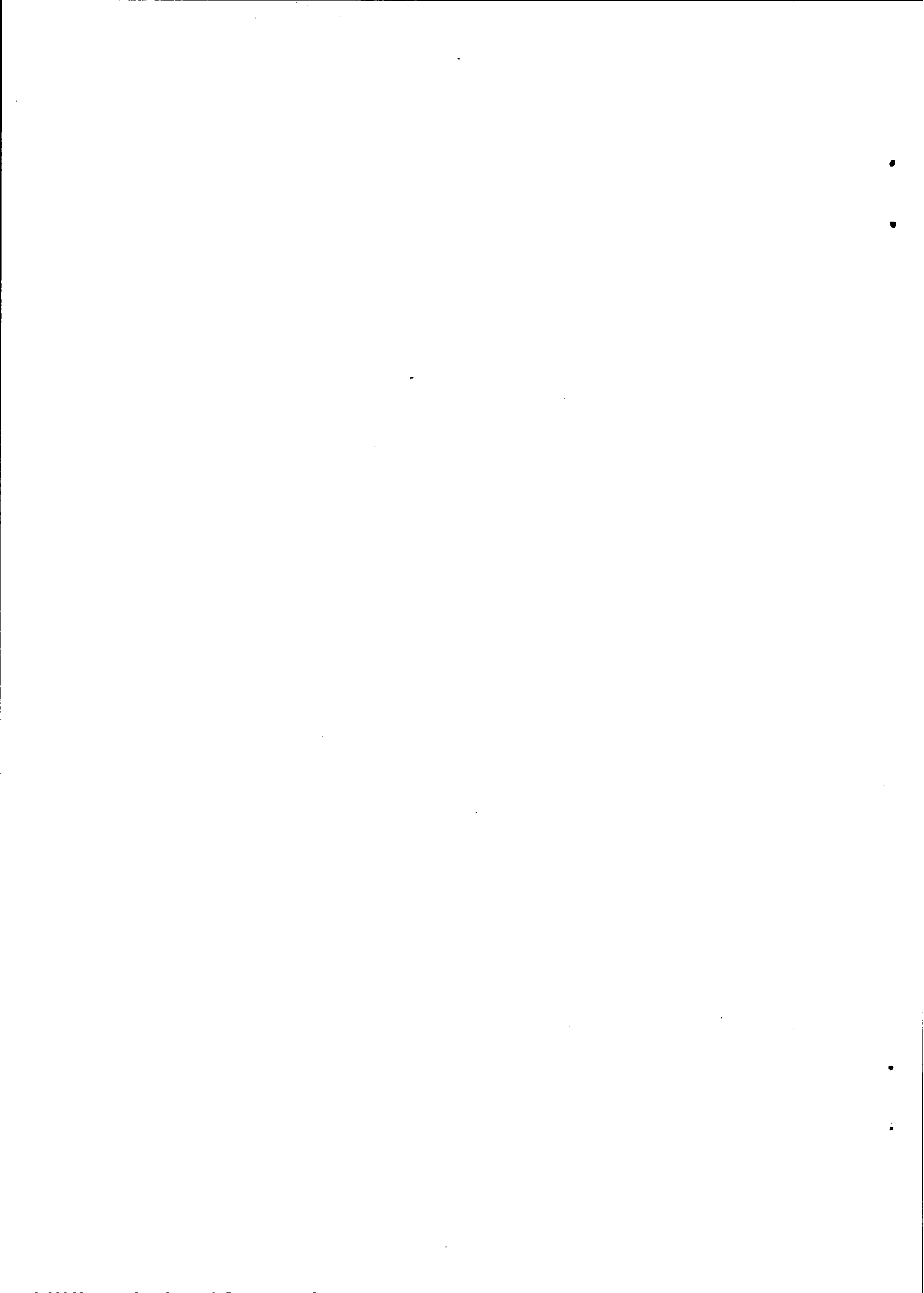

**ORAL CONTRIBUTION OF**

**Dr. K.B. STADIE  
Dept. Dir. General of OECD-NEA**

**Belgian Nuclear Society**

**SYMPOSIUM ON THE SAFETY OF THE NUCLEAR FUEL CYCLE**

**3-4 June 1993**

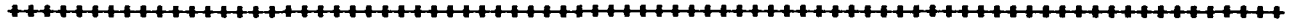

Dr. Baetsle, Dr. Brown, Ladies and Gentlemen.

I am pleased to welcome you to the symposium on the Safety of the Nuclear Fuel Cycle. It is fitting and proper that we should meet in this country - one of the few involved in several stages of the nuclear fuel cycle.

We at the OECD Nuclear Energy Agency are particularly grateful to the Belgian Nuclear Society for this timely gathering which provides an opportunity for our Agency to present our recently published CSNI report on the Safety of the Nuclear Fuel Cycle, updating and improving an earlier version which we issued in 1981.

Ladies and Gentlemen, recent events have focussed world attention on the topic which we will debate during the coming days. You will, no doubt, recall the extraordinary media attention to the plutonium shipment between France and Japan late last year, not to mention the recent accident at the Tomsk facility in Russia. Both have heightened public awareness and concern for the safety of the out-of-pile activities of the nuclear industry.

Thus, the report by the CSNI Working Group could not have appeared at a more opportune moment. The collective assessment, by the best experts in our Member countries, of the ways and means to confine the radioactive substances within safe barriers under all conditions is bound to put these risks into perspective. Moreover, our exceptional efforts to analyse the safety of these plants, to jointly learn lessons from abnormal occurrences during their operation, and the measures to mitigate the consequences of malfunctions, should go a long way in reassuring the public and the political authorities.

In this respect it is perhaps worthwhile to put the safety challenges, and how they are met in the nuclear fuel cycle, into the overall context of the safety challenges which the nuclear industry faces as a whole. Our report addresses this question and notes that "fuel cycle facilities - compared with reactors - are normally operated in both low pressure and low temperature conditions and that in most cases the content of fissile material is sub critical". It therefore concludes that deviations from normal operating conditions of fuel cycle facilities are less likely to develop rapidly into dangerous situations. We therefore have time, which is not always available in the case of a reactor disturbance. The nuclear fuel cycle thus poses less of a threat than reactors and this not only because of the smaller number of plants. Nevertheless, some of the fuel cycle plants have a very large radioactive inventory and many of their operations require a large number of human interventions. Thus, there is the potential for minor incidents and malfunctions which we - at all costs - must keep to an absolute minimum.



Ladies and gentlemen. In my work I frequently meet with the reactor safety community but I have less often the opportunity to address experts in your field. It would therefore seem appropriate to put your work into the context of the Agency's programmes in nuclear safety and regulation.

To begin with, the fundamental safety approaches for power reactors, as well as for the basic radiation protection and radioactive waste management concepts, have been developed by the major OECD countries. The NEA, therefore, provides a focal point for the evolution of thinking and setting of directions in nuclear health and safety.

The four committees in Safety and Regulation, that is the Committee on Radiation Protection and Public Health (CRPPH), the Committee on the Safety of Nuclear Installations (CSNI), the Radioactive Waste Management Committee (RWMC) and the Committee on Nuclear Regulatory Activities (CNRA), bring together the best expertise in our Member countries. The Committees and their ancillary bodies have been instrumental in assessing the state-of-the-art in these areas, in reviewing specific issues, in integrating safety technology and in working towards a consensus on fundamental questions. In this way, we have, for example, aligned national approaches and practices regarding the prevention of severe accidents and the mitigation of their consequences in nuclear power plants.

The long-standing and intimate co-operation of our committees in Safety and Regulation has furthermore created a suitable climate for countries to jointly conduct and finance safety research projects in the framework of our Agency.

We have been particularly successful in the area of reactor safety technology and the assessment of high level radioactive waste repositories. Notable examples are the OECD LOFT, OECD TMI Vessel Investigation (TMI-VIP) and OECD Halden Reactor Projects in nuclear safety and the OECD Stripa and the OECD Alligator Rivers Project in radioactive waste management. We are now in the process of associating reactor safety technology efforts in Eastern countries and in the New Independent States (NIS) of the former Soviet Union, with these programmes. A recent example here is the RASPLAV project, which will bring together 12 OECD countries and the Russian Kurchatov Institute, in joint R&D to analyse the possibility of containing the molten core in the reactor vessel through external cooling of the vessel. If we succeed, we will have taken a huge step towards limiting the progression of a severe accident at a relatively early stage.

Thus, the inherent strength of our Agency is its ability to foster reflective assessments of current issues in nuclear health and safety, with the view to aligning national approaches and to the setting up of co-operative projects. The underlying rationale for our endeavours is the international quality assurance of thinking and this objective also provides the basis for our work in the fuel cycle area.

Turning then to the CSNI Working Group on the Safety of the Nuclear Fuel Cycle. I have noted that, on an average, 12 Member countries participate in its

deliberations. In spite of the constant pressure to transfer resources from your area to reactor safety, we have staunchly defended the existence of your working group, in spite of the fact that many Member countries accord a low priority to these activities. The main reason for our support is our belief that your group provides a unique forum for the collective analysis of important safety issues and is the only international body assuring the international quality assurance of thinking concerning the safety of the nuclear fuel cycle.

The report before us today is an excellent example of this in-depth co-operation. It represents an up to date analysis of the safety and technical aspects of the nuclear fuel facility, beginning with the extraction of the uranium ore, the succeeding steps needed to prepare and manufacture nuclear fuel for use in nuclear power reactors, the recovery and recycling of this fuel after use, and the safe storage of all waste generated throughout these operations. For the better understanding of the less informed readers, our report also describes the operating processes involved throughout the fuel cycle.

Since our earlier report in 1981, the front end of the fuel cycle has not seen many significant changes in the overall production methods leading from uranium ore extraction to the production of nuclear fuel elements. However, from the safety point of view, the attention of OECD Member countries in this area has expanded extensively to include the "in-process" problems and concern and consideration of radiation exposure to workers. Additional focus has also been placed on the impact of these facilities on the environment.

In contrast, in the back end of the fuel cycle major changes have taken place over the last ten years. Spent fuel reprocessing has become one of the major fuel cycle options. World wide experience has been gathered particularly in the large industrial plants which are under operation or construction in OECD Member countries. From the safety point of view, reprocessing of light-water reactor spent fuel is a very complex part of the fuel cycle requiring extraordinary measures in order to minimize the probability of accidents and to limit their consequences.

Even though radioactive waste management and storage was outside the scope of the report, safety aspects of high level liquid waste (HLLW) storage, waste solidification processes and vitrified waste storage were examined. Because the decommissioning of nuclear facilities is becoming an increasingly important activity as plants begin to age, special emphasis was placed on the safety aspects of decommissioning fuel cycle facilities, which are by nature different from nuclear power plants.

As regards the final disposal of radioactive waste, I should note that our Radioactive Waste Management Committee (RWMC) has provided the focal point for in-depth reflection on all aspects concerned with the deep under-ground or the geological disposal of high level radioactive waste. This - perhaps the most controversial issue which the nuclear industry faces - has spurred the RWMC to prepare a series of Collective Opinions. These statements, which in all details have been agreed by the scientific/technical community, summarize in clear and unambiguous terms, the level of knowledge in assessing, constructing and maintaining such repositories and the uncertainties associated with those

predictions. Presently, the Committee is attempting to develop a collective opinion on the environmental and ethical basis for geological disposal, a very ambitious undertaking.

Finally, let me mention that our Working Group on Fuel Cycle Safety has last year established the NEA Fuel Cycle Incident and Analysis System (FINAS). So far very few incident reports have been exchanged but we look forward to an efficient collective learning process, which is bound to reduce the risks from nuclear fuel cycle facilities. FINAS builds on our experience with the Nuclear Power Plant Incident Reporting System (IRS), which CSNI set up in 1980. This system contains today over 2000 incidents and has been on the basis of a wide range of international studies, which continue to enhance the safe operation of nuclear power plants.

Before closing, I should like to take this opportunity to extend our thanks to the Chairman of the CSNI Working Group on the Nuclear Fuel Cycle, Dr. Michael Brown, and to Dr. Baetsle, who preceded him as Chairman of the Working Group and who has chaired the Special Task Force which prepared this report. I should also like to thank him for his initiative in organising this Symposium and I wish you very instructive discussions during the next two days and a pleasant stay in this lovely city of Brussels.

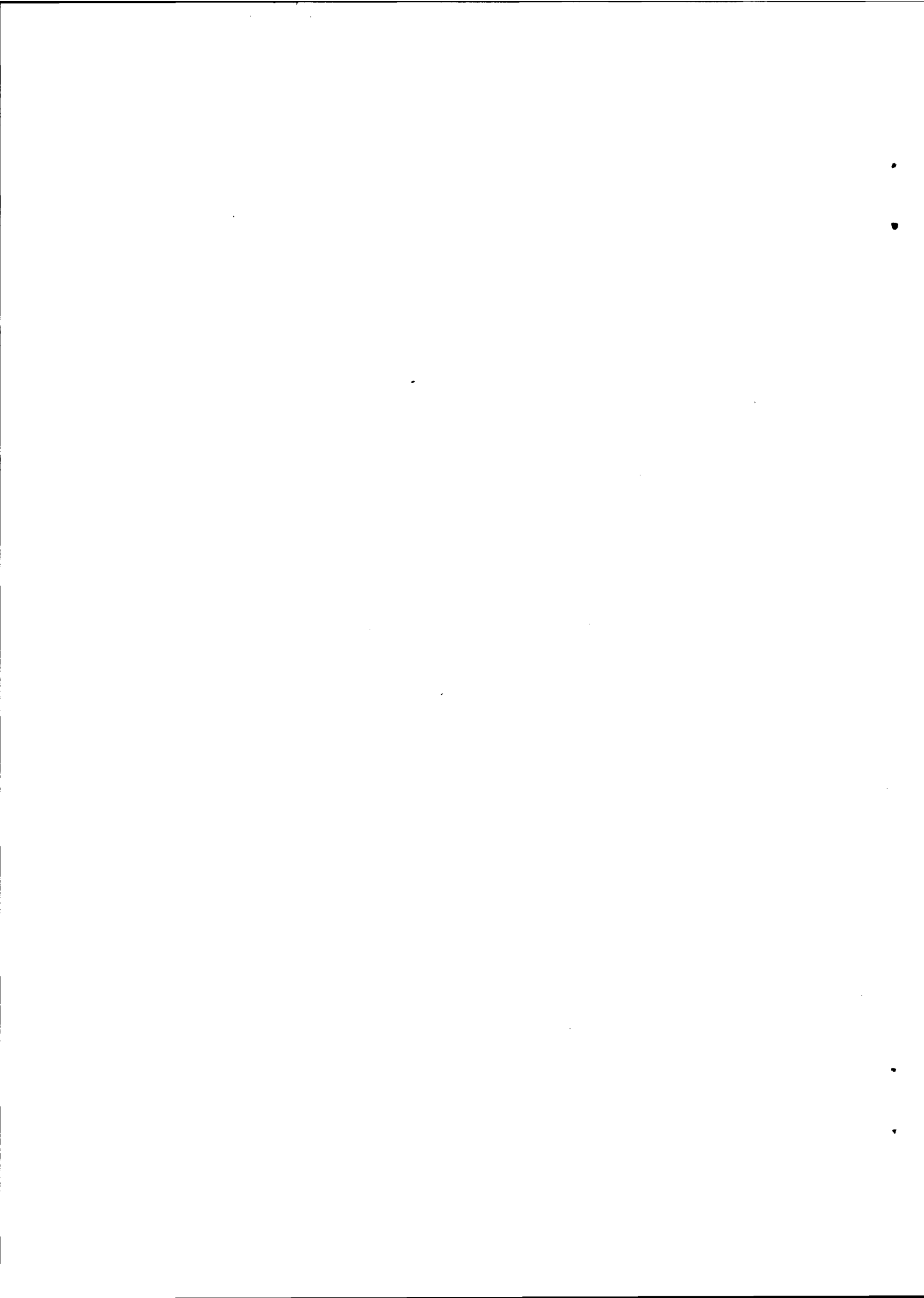

**ORAL CONTRIBUTION OF**

**Dr. L.H. BAETSLÉ  
SCK·CEN, Belgium**

Dr. Stadie, Ladies, Gentlemen, Dear colleagues,

It is a great honour to introduce to you the new OECD-NEA status report on the "Safety of the Nuclear Fuel Cycle". For about 10 years I had the pleasure to chair the OECD-NEA Fuel Cycle Safety Committee, which is the only international committee in which the fuel cycle safety, including reprocessing, has been discussed openly and thoroughly.

As single working group of the CSNI, outside the field of reactors, it was the task of the Working Group on the Safety of the Nuclear Installations (WGSNI) to address periodically the safety issues occurring in the continuously expanding fuel cycle industry.

Over this extended period of time, very few incidents were reported by the OECD-NEA member countries, but each of them gave rise to an analysis in depth of the causes which led to the incident and to a proposal for avoiding the repetition of it and/or the remediation of its consequences. The underlying safety philosophy and the appropriate safety measures resulting from this analysis are at the basis of the new OECD-NEA book "The Safety of the Nuclear Fuel Cycle".

Recently the WGSNI decided to institute the Fuel Incident Notification and Analysis System (FINAS) which ought to become the counterpart of the already operating IAEA-OECD Incident Reporting System (IRS) covering the safety issues in the Nuclear Power Plant and -Reactor field.

In 1987 it was decided within the WGSNI to update and reissue the report of 1981 on the safety of the nuclear fuel cycle.

A task force composed of Mr. M. Kanamori, Y. Naito, L.G. Williams, J. Tew, W. Thomas, H. Auchère, T. Viglasky and myself started the updating. Soon it was clear that a completely new version of the report was required since so much new information was gathered. At the same time we took the decision to prepare a report which was addressed to a much wider public than the previous one.

In the course of 1990 the edition of the new book "The safety of the nuclear fuel cycle" was completed and it is my duty to express my particular thanks to Dr. J. Tew of NII and Dr. Kanamori of PNC who contributed extensively to the genesis of this work.

The book contains 4 major chapters

- The status of the nuclear fuel cycle activities
- The nuclear safety analysis and general safety
- The safety of the individual stages of the nuclear fuel cycle
- Safety records of fuel cycle facilities (from 1957 up to 1990).

Some minor chapters are addressing

- Decommissioning
- Transport
- Overview of the presently operating nuclear fuel cycle facilities.

As already mentioned the operational safety of nuclear power plants and the disposal of wastes were in purpose excluded from this new report.

The most important changes in the overall picture of the nuclear fuel cycle are found in the fuel fabrication (MOX fuel), reprocessing (a 5 to 10 fold increase) and in the extent of knowledge of the environmental impact (radiation doses, waste discharges).

As chairman of the task force which prepared this document I would like to thank contributors from the OECD-NEA secretariat Mr. G. Ishack and Mr. J.P. Clausner for their arduous work in painstakingly overviewing such a specialized publication. Finally I would like to express my gratitude to Mr. R. Berger who managed to review and edit the french version of this document.

I hope that the "Safety of the Nuclear Fuel Cycle" will contribute to a better understanding of this complex matter and will improve the image of the nuclear fuel cycle among a broad section of an educated public to which this publication is intended.

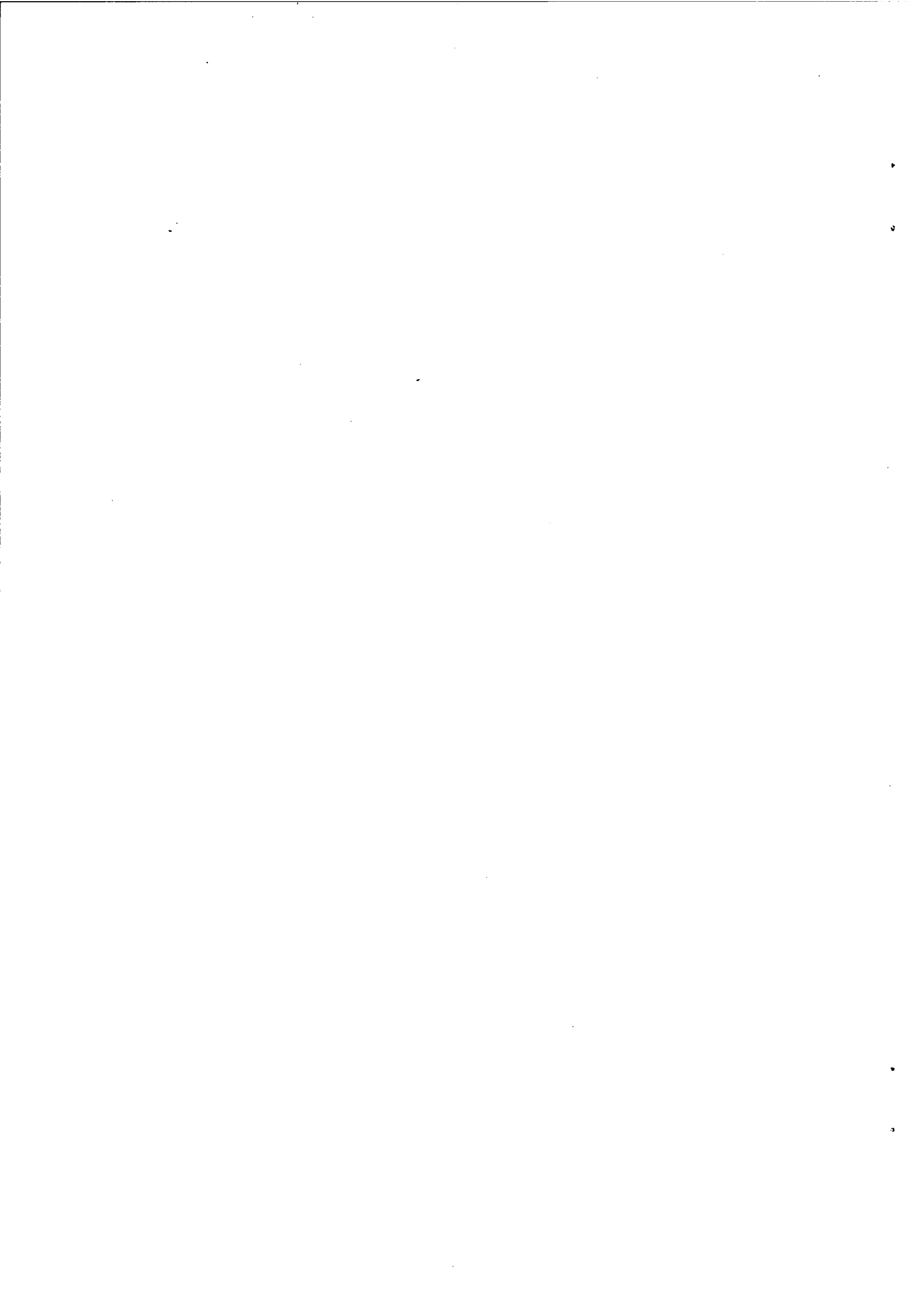



**ORAL CONTRIBUTION OF**

**Mr. L.G. WILLIAMS**



**SUMMARY OF PRESENTATION ON SAFETY PHILOSOPHY OF FUEL CYCLE FACILITIES BY L G WILLIAMS**

Mr Williams gave a presentation on the background to chapter 3 of the OECD book dealing with safety philosophy and the role of the regulator. This topic was not addressed in the first edition of the OECD's book on the safety of the nuclear fuel cycle but Mr Williams explained that it was important for the public to understand the role of Governments and their regulatory bodies and hence obtain an appreciation of the contribution they make to nuclear safety.

Mr Williams identified five principal safety features relating to nuclear fuel cycle plants. The first was the need for high safety standards which are expected by both workers and the public who live near such facilities. The second safety feature related to radiological protection of people working with ionising radiations and the public. Mr Williams explained that most countries based their standards on the recommendations of the International Commission for Radiation Protection (ICRP). The third safety feature discussed related to the responsibility placed on operators to deliver safety through the identification of risks, minimising them and delivering an effective safety culture. Mr Williams felt that the high standards of safety in nuclear fuel cycle facilities were being achieved because the operators recognised that they had a duty to deliver safety and that if they could not deliver their products safely, they would not have products to deliver. The fourth and fifth safety features concerned regulatory control and Mr Williams explained that the development in the nuclear industry of a positive safety culture had benefited from the comprehensive regulatory control of all matters affecting nuclear safety and radiological protection. The total approach to regulation stemmed from the governmental regulatory frameworks and Mr Williams expressed his belief that effective regulation of the nuclear industry enabled the public to acquire the benefits of nuclear technology without being exposed to intolerable risk.

In relation to regulatory frameworks Mr Williams explained that the OECD book set out to show the reader how the regulatory bodies were set up and what their responsibilities were. Mr Williams also explained the role of Governments in setting the statutory basis within which the nuclear industry and its regulators work. He explained that the regulatory body in most countries were provided with powers to control siting, design, construction, operation and decommissioning of fuel cycle facilities.

Mr Williams discussed regulatory body responsibilities. He explained that the regulatory body could be a single body or made up of a number of different authorities. To illustrate the point Mr Williams explained the structure of the regulatory body in the UK. The main point Mr Williams wanted to get across was that the regulatory body was independent of the promoters of nuclear energy, independent of the operators and independent of nuclear plant vendors. This independence ensured that the regulatory body is not faced with the possibility of conflicting requirements which could compromise safety.

Mr Williams went on to explain the main regulatory body activities and their main controls via licensing and regulations. In conclusion Mr Williams summarised his by saying that he believed that the awareness of the importance of safety by the operator, and the independent role of the regulatory had led to high safety standards in the nuclear industry and to the development of a strong safety culture. This situation had not arisen by chance nor had it come cheaply. However, Mr Williams was convinced that current practices, which placed responsibility for safety firmly on the shoulders of the operator and at the same time provided an effective regulatory system to ensure that the operator carried out the responsibility, should provide the public with the confidence that the nuclear fuel cycle facilities were being safely managed.

[Slide 1]

**BNS OECD SYMPOSIUM BRUSSELS 3-4 JUNE**

**SAFETY PHILOSOPHY OF FUEL CYCLE FACILITIES**

Good morning ladies and gentlemen.

1. It is a great pleasure to be here this morning and to have this opportunity to contribute to what I am sure will be a very successful symposium.

2. When I joined the OECD's working group on fuel cycle safety, I was, at the time, responsible for the day to day regulation of BNFL's fuel reprocessing site at Sellafield. For those of you who know Sellafield, you won't be surprised when I say that it was a very interesting and challenging experience. Since then I have moved on and I am now responsible for the regulatory inspection of the UK's nuclear power reactors. I do, however, have fond memories of fuel cycle topics and I was therefore delighted when Dr Baetsle invited me to join you this morning to talk about my contribution to the 'Red Book'.

3. This morning I should like to share with you my views on the importance of safety philosophy and in particular as it applies to the regulatory framework within which the operators of nuclear fuel cycle facilities have to work. As you know this topic was not addressed in the first edition of the Red Book, but when we were preparing for the second edition we felt that it was important for the public to understand the role of Governments and their regulatory bodies and hence obtain an appreciation of the contribution they make to nuclear safety. We decided, therefore, that the new book should give the reader an overview of the regulatory framework and in this way we hoped the public would gain confidence from the strong regulatory influence on nuclear safety.

[Slide 2]

## Safety Philosophy

4. When we looked at safety philosophy we asked ourselves what were the principal safety features that conditioned our thinking about safety at nuclear fuel cycle plants. We identified the five primary features as shown in this slide.

5. The first safety feature relates to high safety standards. The people who work in nuclear fuel cycle facilities and indeed the members of the public who live and work near such facilities expect high safety standards. I believe the operators of such facilities recognise this expectation and do, in fact, operate their plants to the required high standards. However, I also believe that regulatory control plays a part, not only in the development and maintenance of high safety standards, but also in providing the public with the confidence that their health and safety is being safeguarded.

6. Our second safety feature related to radiological protection. This was important because the primary purpose of regulatory control of the nuclear industry is to ensure that workers, and the public, are protected from the effects of ionising radiations. Most countries provide radiation protection standards based upon the recommendations of the International Commission for Radiation Protection (ICRP). My colleague, Dr Naito, will address radiological safety in more detail and I do not, therefore, intend to say anything further on radiation protection.

7. The third safety feature relates to responsibility because safety philosophy is more than setting radiation protection standards; it is also about identifying risks, minimising them and delivering an effective safety culture. I believe the high standards of safety in nuclear fuel cycle facilities are achieved because the operators recognise they have a duty to deliver safety and that if they cannot deliver their products safely, they will not have products to deliver.

8. Our fourth and fifth safety features concern regulatory control. We believe the development in the nuclear industry of a positive safety culture has benefited from the comprehensive regulatory control of all matters affecting nuclear and radiological protection. The

adoption by the regulatory bodies of 'cradle to grave' surveillance ie the setting of standards and then monitoring the operator's achievements through design, construction, commissioning, operation and eventual decommissioning is common to most countries. This total approach to regulation is possible because of the regulatory frameworks governments have set up and I think it is important for the public to appreciate that there are strict controls over who can design, build and operate a nuclear facility. I believe, strongly, that the effective regulation of the nuclear industry enables the public to acquire the benefits of nuclear technology without being exposed to intolerable risks.

*[Slide 3]*

#### Regulatory Framework

9. I believe safety is effectively delivered within a regulatory framework. This requires some form of structure within which the regulators can operate. In Chapter 3 of the book we explain the nature of the regulatory system to show the reader how the regulatory bodies are set up, what their responsibilities are and how they operate to ensure safety is delivered.

10. I should point out that whilst all countries operating nuclear fuel cycle facilities have some form of regulatory control system, the way in which regulation is carried out varies from country to country. It is worth noting, however, that a survey carried out by the IAEA into regulatory practices in countries operating nuclear power stations, showed that most countries had consistent regulatory policies. This morning I will briefly review the role of governments, the structure of the regulatory body, the regulatory body responsibilities and their principal activities.

*[Slide 4]*

## Government Responsibility

11. When we talk about a regulatory framework we are, by definition, referring to the role of government. Clearly, it is for governments to define and implement the statutory basis within which the nuclear industry and its regulators work. It is normal, however, for such legislation to put a duty on the operator to safeguard its workers and the public from its operations. It is also normal for the legislation to establish a regulatory body and provide the powers under which it operates, including the powers to control siting, design, construction, operation and decommissioning of nuclear fuel cycle facilities. Finally, statutes ensure the provision of adequate financial indemnification for third parties in the event of harm that might arise as a result of operations.

*[Slide 5]*

## Regulatory Body Responsibilities

12. Having provided the regulatory framework it is left to the regulatory bodies to carry out the surveillance and control of the industry's day to day activities. The size and structure of the regulatory body varies from country to country. In some countries the regulatory body is a single unit dealing with all nuclear safety, radiological protection and environmental matters. In others the regulatory body comprises several organisations.

*[Slide 6]*

This slide shows the extent of governmental surveillance of the nuclear industry in the United Kingdom where several organisations interact to provide the necessary regulatory coverage.

13. At first sight it looks complex and as if the 'poor old licensee' is constrained on all sides. However, it is not quite as bad as it looks. The yellow boxes show the sponsors of the nuclear industry and how they relate to Ministerial responsibility in England, Wales and Scotland. The mauve boxes show who is responsible for licensing and radiological protection. It is important to note that the HSE, the organisation I work for, is independent of the sponsor. This is a



common feature of regulatory bodies in most countries. The green boxes show the organisations with responsibility for environmental protection matters. In the UK this is separate from the licensing organisation but in some countries a single body performs both of these functions. Finally, the blue boxes indicates the responsibilities for the transport of radioactive material.

[Slide 7].

14. The main point I wish to get across here is that in most countries the regulatory body is independent of the promoters of nuclear energy, independent of the operators and independent vendors of nuclear plant. This independence ensures that the regulatory body is not faced with the possibility of conflicting requirements which could compromise safety.

[Slide 8]

#### Regulatory Body Activities

15. The regulatory body is responsible for a wide range of activities which impact on the operators and hence contribute to the safety of nuclear installations. In most countries the power to regulate the industry is exercised via a licensing process which in general ensures that no person can site, design, construct, commission, operate or decommission a nuclear facility without a licence.

16. This power to grant licences carries with it certain responsibilities to ensure that licences are granted and enforced in accordance with well defined safety principles. Section 3.2.2 of the book lists the range of topics which are covered by safety principles and criteria.

17. Another means of control is via the use of regulations. The production and implementation of regulations and associated guides provides a clear prescriptive statement of what is required of the operator.

18. The licensing process ensures that, inter alia, the operator of a plant cannot do certain things without authorisation from the regulatory body. In order to obtain this authorisation, eg to construct a new plant or make a modification to an existing one, the operator is required to produce a safety case which demonstrates the safety of his proposals. This safety case is then submitted to the regulatory body as evidence to support the application for the required authorisation. The regulatory body, therefore, is required to have the capability of carrying out the review and assessment of such safety cases to ensure that the operator's case is adequate.

19. Licensing also requires the operator to conform to certain limits and conditions and one of the main activities of the regulatory body is, therefore, to check for compliance with these limits and conditions. This checking is done by regulatory inspection. If deficiencies are found the regulatory body can use its powers to enforce compliance. In serious cases the regulatory body may order the operator to curtail or modify his activities. Enforcement powers are also available to take action in the courts to impose penalties.

20. Finally, the regulatory body is responsible for ensuring that the operator has an adequate emergency plan to deal with the remote possibility of failures, or accidents, which could produce an emergency situation. These plans are there to safeguard the workers and the public and it is the duty of the regulatory body to see that the plans are routinely exercised and that the operator performs to an acceptable standard.

[Slide 9]

### Conclusions

21. In this very brief presentation I have explained the role of the regulator, the contribution he makes to the safety of nuclear fuel cycle facilities and the reasons why we felt it was appropriate to include the topic in the revision of the red book.

22. I think the awareness of the importance of safety by the operators, and the independent role of the regulator, has led to high

safety standards in the nuclear industry and the development of a strong safety culture. This situation has not arisen by chance nor has it come cheaply, we must all remember that complacency is a danger we cannot afford and the price of safety is eternal vigilance. However, I am convinced, that the current practices, which place responsibility for safety firmly on the shoulders of the operator, and at the same time provides an effective regulatory system to ensure that the operator carries out this responsibility, should provide the public with the confidence that nuclear fuel cycle facilities are being safely managed.

*Thank you for your kind attention*

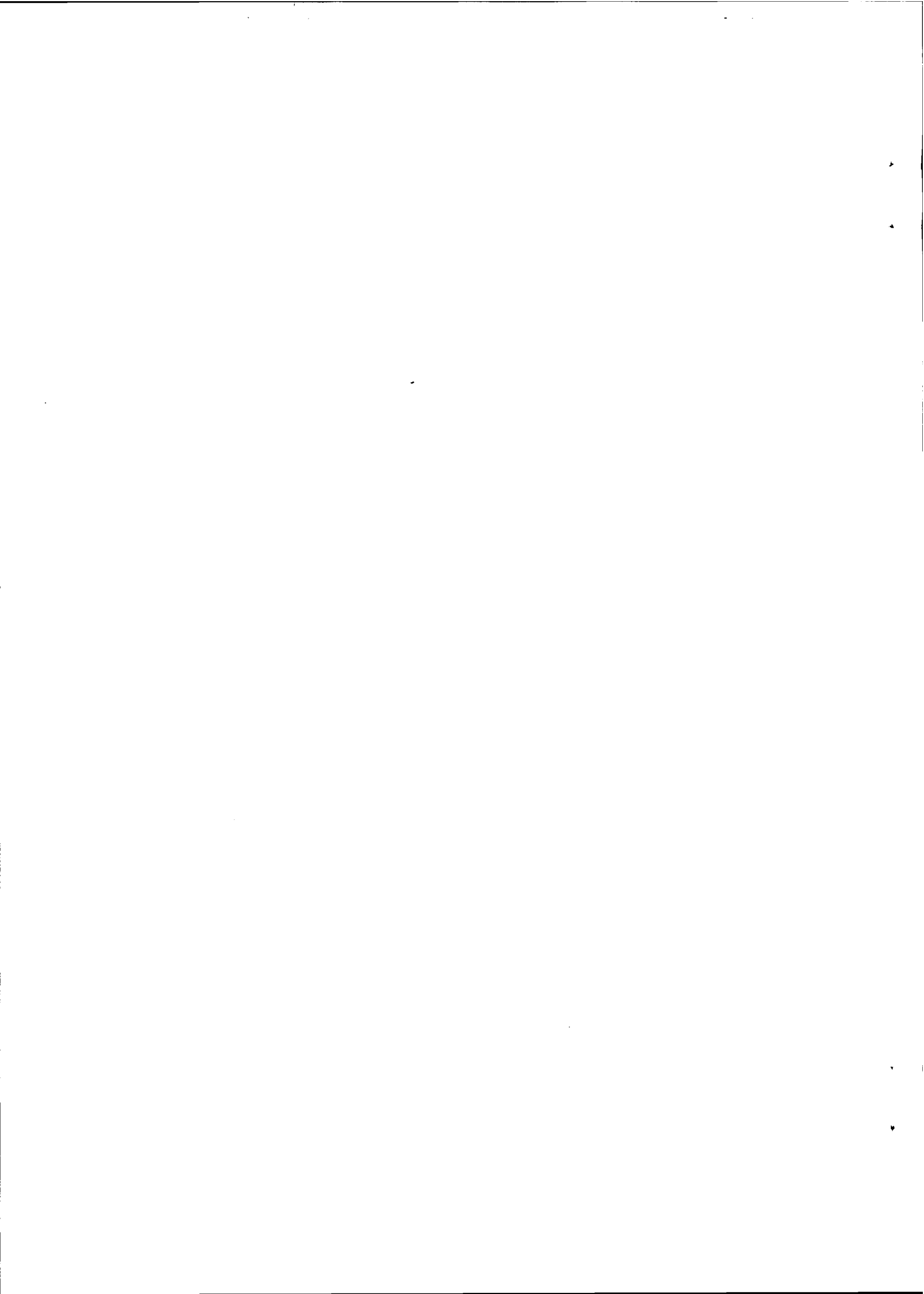

**ORAL CONTRIBUTION OF**

**Dr. Y. NAITO  
JAERI, Japan**

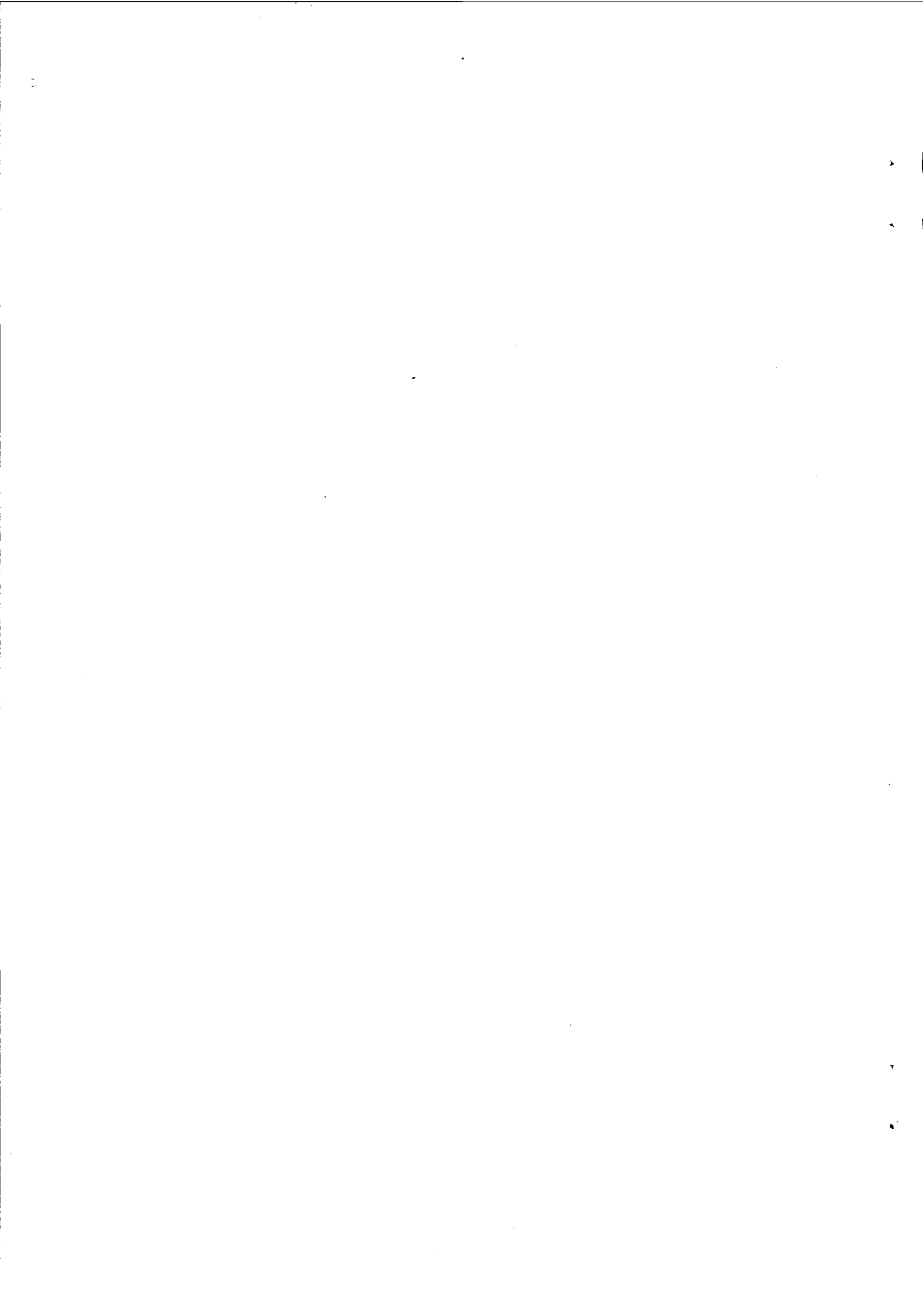

## 1 Seismic Events

As to hypothetical earthquakes considered in the aseismatic design of reprocessing facilities, every country operating or planning them has employed the most adequate earthquake protection methods which take into account historical records, geological structures in sites and nearby regions etc., but has adopted different evaluation methodology. Moreover, such countries have aseismatically classified earthquakes from the viewpoints of the effects of radiation of environment, but differed from each other with regard to concrete evaluation methods of classification.

### 1.1 Seismic Events in JAPAN

The reprocessing facilities in Japan have been aseismatically designed in such way that "Safety Review Guide for Reprocessing Facilities" (established by the Nuclear Safety Commission on Feb.20.1986) is completely met. and thereby any assumed seismic force can not induce any large accident.

Reprocessing facilities which can exert a great influence on environment by the possible release of radiation due to earthquakes is called A class. These reprocessing facilities must withstand the greater seismic force when two seismic forces are compared with each other; one is the seismic force that may give the greatest effects on environment from engineering point of view (hereinafter referred to as "design basis strongest earthquake"), and the other is the seismic force which is three times (3.6 times, in case of equipment) larger than the static seismic force considered in general design of buildings.

A-class facilities, particularly the important ones are called A s class, which, in addition to their capabilities to withstand A-class seismic force, must maintain performing safety functions against possible additional seismic forces that might exert greater influence on sites than these, i.e., the design basis strongest earthquake and which might occur from seismological point of view (hereinafter referred to as "design basis critical earthquake").

Reprocessing facilities which might have relatively smaller impacts on environment due to earthquakes are called B class; such facilities must endure the seismic force which is 1.5 times (1.8 time for equipment) larger than the static seismic force employed in designing general buildings.

Meanwhile, reprocessing facilities which are not classified as A-and B-class facilities are required to comply with the safety standards applied to general industrial facilities and are, therefore, classified as are C class,. They have to withstand the static seismic force (1.2 times for equipment) used in designing general buildings.

The methods for assuming "design basis strongest earthquake" and "design basis critical earthquake" are described in the following sections.

### 1. Design Basis Strongest Earthquake

As shown in Fig. 1 explaining the assuming methods for design basis earthquakes, the design basis strongest earthquake is on the basis of the greatest-effect earthquake selected from information obtained on "past earthquakes" and "highly active faults". Basically, the magnitude of the design basis strongest earthquake is considered to be determined by the past earthquakes. However, since large earthquakes would repetitively occur in the same regions, the following two factors are taken into account; possibility that some old documents are incomplete and the fact that earthquakes due to highly active faults could have impact on the site in the near future where the latter is based on accurate geological evidence and engineering judgment aiming at not overlooking long-repetition-period earthquake which did not happen yet and are unlikely to happen.

As to "past earthquakes", the magnitudes, positions of epicenters, depths of hypocenters, after-shock regions and the scope of damage which gave or might give the site and its neighborhood possibly V-or-more seismic coefficient according to the Meteorological Agency's Earthquake Intensity Scale are well surveyed, and then the consequences of earthquake that may exert the greatest influence on site and its nearby region were estimated.

Within the region of "active fault", examinations of literatures and aerial photographs on geology and geological structures of the site and its neighborhood (land and sea) are sufficiently carried out. As the result of the above, the earthquakes which may exert the greatest influence on the site based on the magnitudes and the positions of epicenters of earthquakes are estimated.

Meanwhile, "active faults" mean faults which have been active in the Quaternary (about 1.8 million years age) and which are likely to continue to be active. Such "highly active faults" might include the followings:



- a. Faults which might cause an earthquake in the past in accordance with historical documents,
- b. Faults with 1 mm / yr-or-more mean displacement velocity, which have been active since 10,000 years or anticipated to cause the next earthquake after less than 10,000 years, and
- c. Faults which are remarkably active at present in accordance with micro-earthquake observation.

## 2. Design Basis Critical Earthquake

As shown in Fig. 1 explaining the methods employed for design basis earthquakes, the design basis critical earthquake is assumed on the basis of the earthquake exerting the greatest influence on site and its neighborhood after conducting investigation on stronger earthquakes than the design basis strongest earthquake from engineering point of view; such investigations are based on the nature of active faults near the site and " seismic zone structure". In addition, the earthquake just on the epicenter having a magnitude of 6.5 is investigated from the viewpoint of safety allowance.

The active faults which are comparatively inactive and which were taken into consideration for the design basis critical earthquake, are considered on the basis of the results of survey carried out for the active faults for the design basis strongest earthquake:

- a. Faults with 1 mm / yr-or-more mean displacement velocity which were active 10,000 years ago or anticipated to cause the next earthquake within 10,000 years more, and
- b. Faults with a mean annual displacement velocity less than 1 mm / yr, which had been active since 50,000 years or anticipated to cause earthquake within less than 50,000 years.

" Seismic zone structure" means the geological structure of a given region provided with spread characteristics and common properties in terms of earthquake occurrence. The geological structure in Japan is composed of several different regions which can be classified in accordance with geological structures and topographies, therefore, the natures of earthquakes in Japan are dependent on the regions. Taking into account this region dependency of earthquakes, the maximum scales and positions of epicenters of the potential earthquakes occurring in each region are assumed. Moreover, the earthquake with a magnitude of 6.5 is required to be investigated in any site as one of the design

basis critical earthquakes on the one hand and to take into account design basis critical earthquakes to keep design allowance from the viewpoint of ensuring aseismic safety on the other.

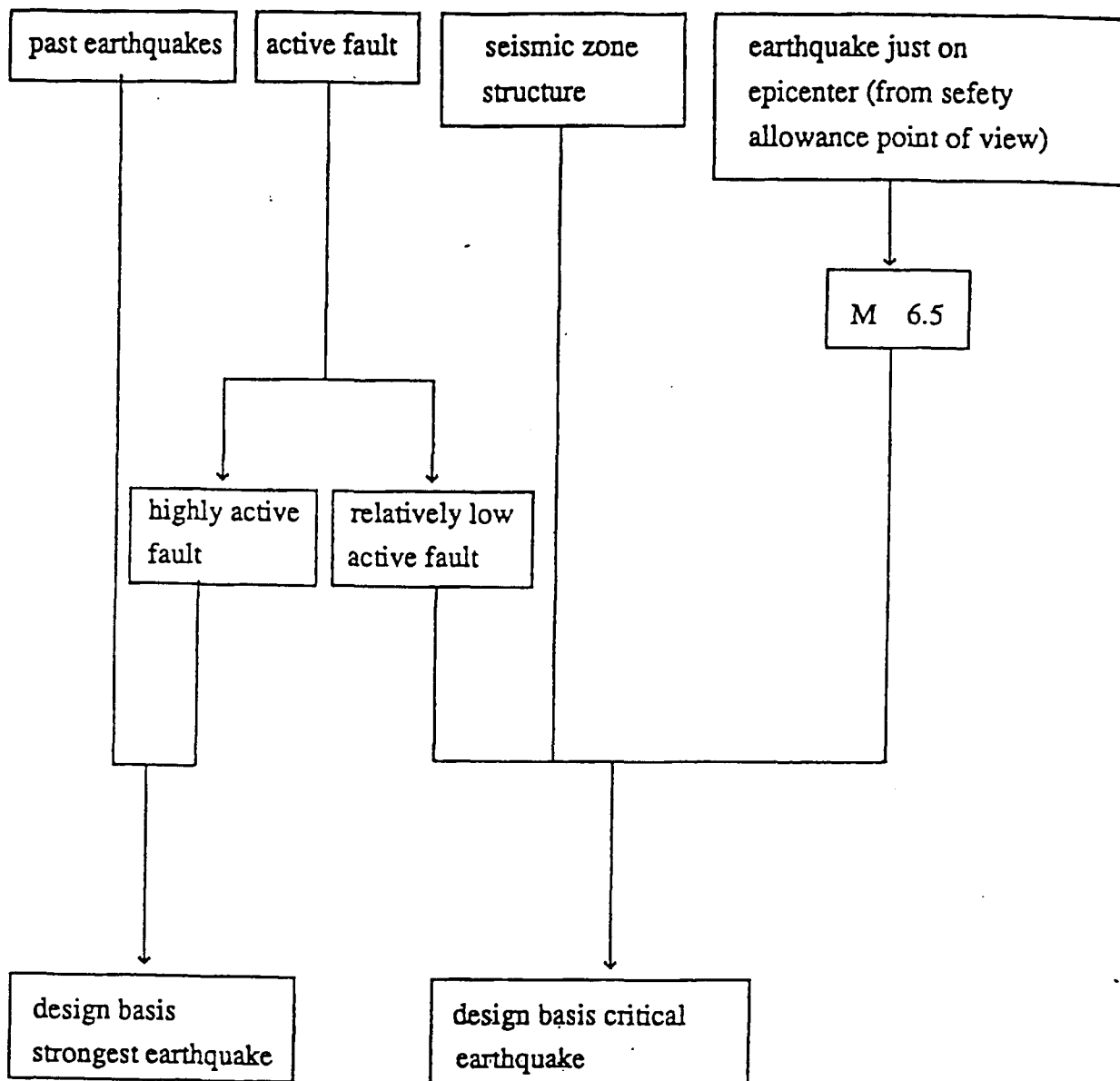

Assuming method for design basis earthquakes

## Aseismatic design classification of facilities

As	seismological hypothetical earthquake
A	static seismic force $\times 3$
B	static seismic force $\times 1.5$
C	Static seismic force $\times 1.0$

**ORAL CONTRIBUTION OF**

**Dr. M. KANAMORI  
PNC, Japan**

BNS /OECD-NEA Symposium on the  
SAFETY OF THE NUCLEAR FUEL CYCLE  
BRUSSELS, 3-4 June 1993

## SEFETY OPERATION OF TOKAL REPROCESSING PLANT

Masashi KANAMORI

Power Reactor and Nuclear Fuel Development Corporation

Tel: 03-3586-3311, Telefax: 03-3505-5125

### ABSTRACT

Since the start of hot operation in 1977 at Tokai Reprocessing Plant (TRP), the total amount reprocessed fuel reached about 600 tons of irradiated fuels. Almost 15 years of operational experiences demonstrated the safety, feasibility and industrial validity of oxide fuel reprocessing technology in Japan. This paper describe the following three areas, the present operational status, Plant modification procedure and trouble experiences at TRP, from the point view of safety. The role of Plant Security Regulation, Safety Superintendent, Regulatory Periodical inspection are presented in the first part, which also shows the value of radiation exposure of personnel and amount of activity discharge from the plant. The installation of new effluent discharge pipe line is presented as an example of plant modification in the second part. The incidents occurred recently are briefly analyzed at last.

#### 1. Present Status of TRP

##### 1.1 Operational History and Achievement

###### 1.1.1 History of TRP

The reprocessing protect of the PNC was started in September 1956 when the Atomic Energy Commission(AEC) of Japan decided that reprocessing of spent fuel and treatment of radioactive waste should mainly be done by the Atomic Fuel Corporation(AFC). In 1959, an Advisory Committee for reprocessing was formed within the AEC to formulate a guideline for development of the reprocessing technology. In conjunction with the recommendations put forward by a survey team which visited overseas reprocessing plants, a decision was made to construct reprocessing plant using the advanced technology developed by other countries.

In 1963, the AFC entered into a contract with the Nuclear Chemical Plant(NCP)of UK for a preliminary design of the plant, and in 1966 a detailed design was started by the Societe Generale pour les Techniques Nouvelles(SGN) of France. Since 1968 and in parallel with the ongoing detailed design, the governmental licensing procedure had been followed and permission for plant construction was granted by the Japanese Government in 1970.

Plant construction was started in 1971 as a joint venture of SGN-JGC of Japan. The Plant was completed in 1974 and hot testing started in September 1977 after completing the U testing using unirradiated uranium. Up to the end of 1993 the total amount of reprocessed fuel from LWRs and the ATR Fugen(Advanced thermal reactor using heavy water as the moderator)was about 680 tons.

###### 1.1.2 Amount of Reprocessed Fuel, Major Maintenance Activities and Scheduled Shut-down of Plant Operation

#### 1.1.2.1 Amount of Reprocessed Fuel

The total reprocessed fuels from the start of hot operation on 22nd of September 1977 to the end of 1993 is about 680.2 ton of oxide spent fuel. The kind of spent fuel assembly is as follows, BWR PWR, ATR Fugen Mixed Oxide Fuel: which gave us valuable experiences for MOX fuel reprocessing.

The amount of plutonium nitrate recovered as a final product was about 3.9 tons, and most of Pu has already been sent to Pu conversion Plant for use at the ATR Fugen, the experimental FBR Joyo, and proto-type FBR Monju.

#### 1.1.2.2 Major Maintenance Activities

##### (1) Remote Repair of Dissolver R10 and R11

In April 1982, a small amount of radioactivity was found in the steam condensate from a dissolver. After confirming that one of the two dissolvers R11 had small defects which consist of pin holes in the welded part on the barrel of dissolver, operation was resumed using R10 dissolver until February 1983 when dissolver R10 had same kind of defects. The remote repair technology had been developed, and from September to November 1983 the in-situ repair of two dissolvers was carried out successfully first time in the world.

##### (2) Installation of New Dissolver R12

Leakages in the two dissolvers occurred rather unexpectedly and subsequently the third dissolver was installed in a spare dissolver cell. A new dissolver R12 was fabricated with improved material and welded lines were eliminated from the inside steam jacket as for the design. A fabrication of dissolver was finished in April 1984, and was installed by the end of November 1984.

##### (3) Repair of Acid Recovery Evaporator

During the final stage of hot testing in August of 1977, a minor leak was detected which was caused by pin holes of welded part of heating tube in the acid recovery evaporator, and an exchange of whole part of evaporator was done after decontamination and dismantling of leaked evaporator by end of December 1979. However, the new one leaked again in February 1983 caused by corrosion of heating tube, and at that occasion only boiler part of evaporator was replaced with domestic produced materials. The repairing period was seven months which was shorter compared with former one.

#### 1.1.2.3 Scheduled Shut-down of Plant Operation

The operation of TRP became steady and stable since 1985 after many modifications and improvements, however, the requirement of increasing the reprocessed amount at the TRP is stronger than before because of demand for more plutonium of the ATR and FBR fuel cycle development.

The design capacity of TRP is 0.7 tons per day, and operational license permits the TRP to reprocess up to 210 tons per year. Although it was difficult to reach this maximum, because yearly inspection, the physical inventory takings(PLT)of nuclear material and periodical maintenance works. The operational total days of TRP per year had been calculated as about 170 days, and assuming the average plant efficiency factor of 60% the derived yearly production of TRP had been about 70 tons.

For the improvement of the production rate, one is augmentation of operation days and another is to ameliorate the plant performance factor. The operational yearly days were increased by shortening of maintenance and regulatory inspection period, and for the plant efficiency factor, it became clear to improve and modify the fuel assembly shearing process and clarification process for dissolved fuel solution. In the long range, it

was also obvious to prevent the sudden stop of plant operation, which will be caused by failure of major equipment due to corrosion. Therefore the scheduled shut-down of plant operation was set to replace the acid recovery evaporator, and to make modification of fuel assembly shearing process, clarification process etc..

**(1) The Replacement of the Acid Recovery Evaporator**

The first acid recovery evaporator leaked in 6000 hours of use, and the leak of second one was occurred in 13,000 hours use. The material of evaporator was 25%-chromium and 20%-nickel alloy of stainless steel, and the conservative estimation was that the third evaporator would leak again in 13,000 hours of use, which was expected around the half of 1988. On the other hand, the development of corrosion resistant material was done continuously since the day of leak of first evaporator, and it became evident that the titanium and 5%-tantalum alloy material shows a good corrosion resistance behavior in this corrosive environment.

The decision was taken to replace the third evaporator with the new one made of Ti-5%Ta alloy. This work was started in June 1988 and was performed smoothly within scheduled 11 months period, based on the old experiences of two times replacement so far.

**(2) The Replacement of Plutonium Solution Evaporator**

The design of original plutonium evaporator was to connect the washing column to boiler part with the flange, and the material of former one was stainless steel and latter one was corrosion resistant titanium. For the column part a pin hole defect appeared in year 1982 after 10,000 hours of operation and insitu repair was done. In year 1984 the replacement of whole evaporator was done after 12,000 hours of operation.

The decision was made to replace this evaporator because of 9,000 hours of operation, and the material of column part was chosen as Ti5% Ta alloy to prolong the operational life. The improvement was made to remove the flange connection by welding the titanium and Ti5% Ta alloy. The replacement was done in the cell within three months.

**(3) Modification of Boiler part of Acid Recovery Distillator**

The acid recovery distillator was fabricated from the stainless steel, and in February 1981 the corrosion leakage was occurred on the part of heating coil after 13,000 hours of use, and repair work was done within 1.5 months. In 1984 the boiler part of distillator was replaced within 4 months.

The new distillator was installed to replace old one which operation time was about 13,000 hours of use. The new distillator has separable heating tubes from boiler part of distillator for easy maintenance.

**(4) Modification of Fuel Assembly Shearing Machine**

Many modification works for internal parts of shearing machine were done to improve the operability and maintenance ability.

**(5) The Addition of Second Pulsed Filter**

The clarification method of the TRP was to use pulsed filter. The filtration of dissolver solution clogs the sintered stainless filter gradually and finally it will necessitate the replacement of filter cartridge affecting the plant.

To improve the plant efficiency factor, second pulsed filter was added in the clarification process. The new type of valve for changing use of both filters was developed to install inside cell for easy maintenance and high fidelity. The modification works inside cell was done after tedious decontamination of equipments and piping, and working time was limited because of still rather high radiation dose. The time of total



installation work was more than one year after delay of four months for final modifications.

#### 11.1.2.4 Evaluation of Major Modifications on Plant Performance

The scheduled shutdown of plant operation continued 15 months, and the PNC person who is involved in this work were around 500 and the number of contracted workers of constructor and engineering firms were about 1,600 (about 100,000 manday). The accumulated radiation dose of person was 5 man.Sv (500 man.rem), which is higher than average 1-2 man.Sv/year of record of the TRP operational staff exposure rate.

The original intention of improving the plant was to increase the yearly processing amount from 70 tons to 90 year in September 1990 the reprocessed amount was 83 tons of spent fuel and during the year 1990 from January to end of November 99 tons of fuel was reprocessed.

### 1.1.3 Plant Security Regulation, Manuals for Safety Operation and Committee for Plant Safety

#### 1.1.3.1 Plant Security Regulation

To operate a reprocessing plant in Japan, operator is required by the Regulatory Law (Law for Control of Nuclear Source Materials, Nuclear Fuels and Reactors) to stipulate Plant Security Regulation (PSR), and to get approval on PSR from the Prime Minister. The content of PSR is specified the Ordinance for Control of Spent Fuel Reprocessing Operations as follows;

- (1) Organization and workscope of employee and supervisors
- (2) Safety education and training for employee
- (3) Handling of special device and equipment required special control for safety
- (4) Safety, evaluation for operation
- (5) Setting of control area, security area and surveillance area around plant, and control of intervention
- (6) Monitoring of effluent discharge from airborne and marine
- (7) Radiation control of dose rate, radioactivity concentration and surface contamination
- (8) Control of radiation detectors and method of measurement
- (9) Surveillance and inspection method for routine operation
- (10) Periodical inspection
- (11) Handling of nuclear material for transportation, reception, shipping and storage
- (12) Disposal of radioactive waste
- (13) Environmental surveillance near the site including the sea discharge point
- (14) Procedure for emergency situation
- (15) Keeping of record related to security
- (16) Others related to security of plant

#### 1.1.3.2 Manuals for Safety Operation

PSR specified many important requirements, specifications and operational limit of value, however more detailed standards and manuals are necessary for the operation. Safety Standards, Radiation Control Standard and Criticality Prevention Standards are established to keep the operation safely.

#### 1.1.3.3 Committee for Plant Safety

To comply with the PSR, the Safety Evaluation Committee of TRP is founded to examine, (i) Modification of above mentioned Standards, (ii) important matters related to operation, (iii) important matters related maintenance, (iv) investigation and prevention method related to unusual situation and emergency situation, (v) Licensing application for

modification of TRP. Members of this committee are selected within employee of Tokai Works.

#### 1.1.4 Safety Superintendent

State Minister for Science and Technology Agency(STA) will give license who succeed examination for Safety Superintendent Handling Nuclear Material. Regulatory Law requires operator of reprocessing plant to inform the prime Minister of the name of Safety Superintendent within employee who hold license. The responsibility of safety Superintendent is to supervise the security connected with the handling of nuclear material. The more detailed duty is defined in PSR.

#### 1.1.5 Regulatory Periodical Inspection

The Regulatory Law stipulates that Regulatory Periodical inspection (RPI) should be conducted within 12 months after getting the permission from the Prime Minister for Previous RPI. The actual RPI is conducted by STA officials. The inspection goals are stated in the Ordinance for Control of Spent Fuel Reprocessing Operations as follows;

- (1) Alarms, emergency generators, safety protection systems or related equipment react in accordance with working conditions defined in application documents which was submitted for licensing
- (2) Capacities of radioactive waste treatment facilities are above the values defined in application documents
- (3) Performances of radiation control facilities are satisfactory compared with application document
- (4) Radiation doses and air contamination level are below the values shown in application document
- (5) Protection system for criticality control and confinement capability for radioactivity are satisfactory compared with application document
- (6) Activity level of predict is below the value is defined in application documents
- (7) Recovery rate of product is above the values defined in application documents

#### 1.1.6 Others

In TRP, since August 1986, the group activity, which is called reprocessing small numbered group activity (in Japanese, Saishori Shoushuddann Katsudou,SSk) related to the operation of plant has started and it is very dynamic. The number of group is 82 circles and total participants is 555 employee by the end of March 1991.

In every six month, SSK convention is held to present the activity of each other circles representing eight sections. The awards are presented to winners for their achievements. The category of theme is widely distributed from quality control, safety, efficiency. cost reduction, standardization, etc... SSK is one of key activity to promote safety culture in TRP.

#### 1.2 Radiation Exposure Control of Plant Personnel

Radiation control at TRP is based on the authorized regulation in Japan and the ALARA principle. Occupational exposure is limited in the regulations, i.e. effective dose equivalent limit of 50 mSv in a year. The control area is divided into three types of area depending on radiation levels which are called green area, amber area and red area respectively. Red area is the cell type rooms containing instruments or vessel with high level of radiation, where personnel is usually prohibited entering into except for repairing or replacing the equipments. To minimize exposure and avoid excessive exposure of an individual in the plant, investigation levels for exposure are set over three months, e.g. 3 mSv for effective dose equivalent.

Measurements of radiation fields are conducted for the purpose of avoiding excessive exposure of personnel and confirming that working environment is satisfactory for operations. Exposure rates and concentrations of airborne radioactive materials are measured continuously by the automated monitoring system. Signals of detectors are centralized into the health physics panels in the safety control room. Annual collective dose equivalent was around 1 man.Sv during normal TRP operation.

### 1.3 Activity Discharge from the Plant

In the normal operation of TRP, low level radioactive effluent are discharged to the atmosphere and the ocean under rigid control. Radiation exposure to the public around the plant have been estimated for the potential pathways with the site specific parameters such as food consumption, concentration factors of marine organisms and meteorological condition.

External exposure due to gamma ray from  $^{85}\text{Kr}$  and internal exposure via inhalation and oral intake of radionuclides are evaluated for the airborne effluent. External exposures to contaminated fishing net and fishing boat are considered as pathways for fishermen. External exposure to contaminated beach and internal exposure via oral intake of marine products are evaluated for the liquid effluent.

Estimated annual effective dose equivalents are only less than 0.1 percent of the annual effective dose equivalent limit for the public recommended by the International Commission on Radiological Protection(ICRP) since the operation the TRP was started in 1977.

The results of environmental monitoring including the value of effluent discharge are submitted to "Central Evaluation Advisory Committee for Environmental Radiation Monitoring", which was the advisory group of Nuclear Safety Commission(NSC), for assessment of monitoring result. The assessment results are reported to NSC and are published by NSC's and are published by NSC's periodical.

Since October 1991, monitoring of atmospheric C-14 discharge was included in monitoring program of TRP, because of its unnegligible impact compared with other nuclide, during the licensing procedure of new marine discharge pipe line, which updated dose assessment to the public.

## 2. Plant Modification Procedure

### 2.1 Licensing Procedure

Operator of reprocessing plant is permitted to operate plant only after pass the inspection and getting the approval of Prime Minister. To modify the licensed facilities, same licensing procedure is required according to the Regulatory Law.

### 2.2 Installation of New Effluent Discharge Pipe Line

The new effluent discharge pipe line was installed in October 1991. The discharge point from the old pipe line will be reclaimed by Tokyo Electrolytic Power Company and Power Development Company to construct coal fire plant, therefore, the installation of new pipe line became necessary.

The pre-hearing for application for modification of initial Application Document was started in July 1989 between STA officials and PNC employee, and an application was submitted by December 1989. During licensing the auxiliary application for minor change was added in August 1990, and finally the application was permitted in December 1990. In parallel with this licensing, a pre-hearing for the application for the Design and Procedure construction of new pipe line was started December 1990, the formal application was proposed January 1991 and approved by end of January.

The construction work was onset beginning of February and was completed by the end of October 1991. The application for regulatory inspection was submitted February,

and three time inspections was conducted before getting licensing by the middle of October 1991.

### 3. Incident

#### 3.1 Criteria for Reporting of Incident

The Ordinance for Control of Spent Fuel Reprocessing Operations specifies the incident reporting criteria for facility operator, and request them to inform soon to the Minister of STA of incident's situation, and within ten days to submit report indicating the circumstance, cause and preventive measure etc.

Criteria for reporting of incident indicated in the Ordinance is as follows;

- (1) Theft or disappearance of nuclear material.
- (2) Malfunction of reprocessing facility (except minor one which affect the operation of facility a little).
- (3) Abnormal leakage of spent nuclear fuels etc.
- (4) Radiation of facility operator exceeds or possibility of exceeding the effective dose limit specified in other Ordinance.
- (5) Occurrence of injury or possibility of injury (except the normal and not related radiation and minor injury)

#### 3.2 Analyzed Incident

### 4. Conclusion

The design of main process of the TRP was made in abroad and the improvements and developments were done from the start of construction to today to accommodate the various situations in Japan, specially to decrease the amounts of effluent discharge from the plant. The environmental impact has been minimized from the start of operation.

In 15 years of TRP operation, there is no major accident which affect the plant safety and plant personnel.

Even minor incidents were well cautioned and analyzed to improved plant safety.

The initial aim of demonstration of safety of oxide fuel reprocessing is fully achieved, and recovered plutonium is thoroughly used for PNC's reactors, "Joyo", and "Monju". The future plan for the TRP is to toward the more R&D oriented areas.

### REFERENCE

(1) NAKAJIMA,K.,NAKAMURA,Y., "Results and experience of nuclear fuel cycle technology development by PNC: Operating experience with the Tokai Reprocessing Plant", Nuclear Power Experience(Proc.Conf.Vienna,1982), Vol.3,IAEA, Vienna (1983)825-829

(2) TSUJI, T., YAMANOUCI, T., TAKAHASHI, FURUKAWA, H., "Development and improvement of Reprocessing Technology at the TOKSAI Reprocessing Plant", Proceedings of an International Symposium on the Back End of the Nuclear Fuel Cycle:Strategies and Options, IAEA, Vienna, 1983

(3) OMACHI,S., YAMANOUCI,MATSUMOTO,K., "Operational Experience of the Tokai Reprocessing Plant"International Conference on Nuclear Fuel Reprocessing and Waste Management "RECOD87", Proceedings Vol.1, Paris(1987)195-202

(4) SHINOHARA,K., "Environmental Dose Assessment for Low-Level Radioactive Effluent Discharged from Tokai Reprocessing Plant", Proceedings of the CSNI Specialist Meeting on Safety and Risk Assessment in Fuel Cycle Facilities, Tokyo(1991)361-367

(5) SHINOHARA,K ,ASANO,T.,"Environmental Dose Assessment for Low Level Radioactive Effluents Discharged from Tokai Reprocessing Plant", Health Physics Vol.62, No.1 (1992) 58-64

(6) TAKASAKI,K.,EBANA,M.,NOMURA,T., "Radiation Control System at Tokai Reprocessing Plant", Proceedings of "RECOD 91"Vol.1, Sendai(1991)219-223

(7) MITAHARA,K.,YAMAMURA,O., TAKAHASHI,K.,"The Operational Experience at Tokai Reprocessing Plant", Proceeding of "RECOD91"Vol.1,Sendai(1991)49-54

(8) YAMAMURA,O., "Safety Operation of Tokai Reprocessing Plant" International Forum Organized by the Japanese Nuclear Commission, Tokyo January 1992



**ORAL CONTRIBUTION OF**

**Dr. T. VIGLASKY  
AECB, Canada**

My presentation will briefly highlight the sections of the Safety Report dealing with the front end of the fuel cycle, namely uranium mining and milling, refining, the production of  $UF_6$ , and uranium fuel fabrication.

Firstly, this sector of the nuclear industry has been financially ravaged over the last number of years due to the drop in demand for their products and services because of the dumping on to the world markets of former Soviet Union state-origin material and other low-cost producers, and from the sale of surplus uranium by utilities.

The price of uranium hit a relative all-time low during this period.

This has caused all but the most efficient and the low-cost producers, and providers of conversion and enrichment services, to either severely cut-back or cease their operations. It is unlikely that, other than for uranium mines, new front-end facilities will be constructed in the near future. The main task for present operators is to adequately maintain their facilities to ensure their continued safe operation.

#### Uranium Mining and Milling

The mining and milling of uranium do not give rise to safety problems of a nature or type which are associated with the operations of nuclear power reactors or other fuel cycle facilities. The safety concerns with uranium mining and milling generally fall into two categories: the first involves the protection of the workers against the risks of exposure to external gamma radiation, the inhalation of radon daughters, and the inhalation of radioactive dusts; the second concerns the protection of the public and the environment from the long-term effects of uranium mill tailings.

The protection of the workers from exposure to radiation has been advanced over the last number of years. Adequate ventilation will control exposure to radon daughters, and conventional dust-suppression precautions will minimize the generation and resuspension of



radioactive dusts. Generally in the past, exposure to gamma radiation has not been a problem. However, with the development of high-grade uranium deposits, as in Canada, special precautions and new mining methods need to be developed to protect the workers against this new hazard.

The implications of the ICRP-60 recommendations have not been completely assessed. However, implementation of the recommendations could severely impact some mining operations.

The negative impacts from uranium mining tailings are as a result of mining operations which have taken place over the last 50 years. Governments are making significant attempts to rectify and mitigate the environmental and health implications of these past practices. All new uranium mining ventures that are proposed in developed countries must meet very stringent environmental criteria, which in probably all cases exceed the requirements imposed on other mining activities.

Again, worker protection programs are required to prevent the inhalation of uranium compounds, and to minimize their exposure to radiation fields.

#### Uranium Refining and Conversion to Uranium Hexafluoride

The existing processes for refining uranium and conversion to  $UF_6$  give rise to no significant radiological hazards during normal operations. The safety problems associated with these operations are essentially those of a conventional chemical industry dealing with toxic chemicals, the main hazard being the handling of large quantities of HF, and the handling of liquid  $UF_6$ , which if released to the atmosphere produces HF and uranyl fluoride ( $UO_2F_2$ ).

Safety analyses regarding these operations must be carried out to ensure that the design, construction and maintenance of the processing facilities are maintained to high standards.

Worker protection programs are aimed at the prevention of inhalation of uranium compounds, and to ensure that the few operations that could give rise to significant gamma radiation exposures are properly controlled, and that the workers have adequate training and supervision.

#### Fuel Fabrication

Due to the low radiotoxicity of natural and slightly enriched uranium, only limited off-site environmental consequences are to be expected following an accident. During the design phase, the safety assessment must address the internal and external events which could impact on the safe handling of  $UF_6$ , and ensure that criticality concerns have been considered for all phases of the facility's life.

Of equal importance is the safe and reliable operation of the facility because, as in all aspects of the fuel cycle operations, experience has shown that non-routine operations and human error are the main contributors to incidents.

#### Enrichment

Briefly, my statements on  $UF_6$  production and fuel fabrication would apply equally as well to the uranium enrichment operations.

In summary,

- the front end of the fuel cycle is operating safely, and there are no outstanding major safety issues that must be resolved to ensure continued safe operation;
- the operators and regulators must continue to assess the operations to ensure that high standards are maintained;
- emphasis must be maintained on worker training and supervision. If an incident occurs, it will probably be due to some aspect of human error.

**Texte présenté à BRUXELLES lors de la réunion OCDE du 2 au 4 Juin 1993**

**FRONT END FUEL CYCLE SAFETY  
HUGUES AUCHERE**

**This paper presents a general survey of the main safety problems arisen in the front end of the fuel cycle, that is conversion of uranium oxide to UF<sub>6</sub>, enrichment of uranium, and fuel fabrication. I will say only generalities but in the little red book, you will find details about these topics, on the one hand, in part 2 for the descriptions of the processes, on the other hand, in part 5 for the safety assessment. I will resume this in few minutes and I will say also some personal considerations.**

**First point - Conversion and enrichment**

**To-day ninety per cent of the world uranium production is used in light water reactors after enrichment in U 235 isotope. This enrichment is operated by two industrial processes : gaseous diffusion and ultra-centrifugation. In both cases, the operation involves a gaseous compound of uranium, the hexafluoride or UF<sub>6</sub>. So it is necessary to transform the uranium oxide in this compound ; this process is called conversion.**

**The safety problems of the conversion and enrichment processes will be detailed this afternoon by Mister Charles for the diffusion process as operated in the Eurodif french plant, and by Mr Dekker for the centrifugation process in the Urenco plant.**

**In this processes, conversion or enrichment, the main risk for the public is the release of UF<sub>6</sub> in the atmosphere ; in this case a chemical reaction occurs between gaseous UF<sub>6</sub> and the steamy atmosphere which produces the very toxic hydrogen fluoride. Two important accidents occurred in the world : the first one in nineteen seventy seven at Comurhex french plant with a release of seven tons of UF<sub>6</sub> in the atmosphere during fifteen minutes, but this accident was without significant consequences ; the second one at the Sequoyah Fuel Plant in U.S.A. which unfortunately caused the death of a worker. There are two kinds of characteristics of UF<sub>6</sub> risk :**

- at first the risk is a chemical toxic risk, with very limited radiological consequences**
- secondly, the rapidity of the atmospheric dispersion which limits considerably the intervention possibilities of emergency plan.**

**In the future, it is possible that the laser enrichment process will be used ; in a way of this process (SILVA in France, AVLIS in USA), the enrichment is operated directly on atomic uranium vapour, without UF<sub>6</sub> risk.**

### **Second point : Uranium oxide fuel fabrication**

The first operation is the UF<sub>6</sub> reconversion in UO<sub>2</sub> with the same chemical risk as in conversion and enrichment plant.

The main other risks are at first, the criticality, which is well known and limited by very strict precautions and secondly the dissemination of UO<sub>2</sub> powder. For this, the risk can affect the workers because the process is not performed in tightly containment ; by the application of the new IRCP limits it will be perhaps necessary to improve the containment of the processes which involve uranium powder. This will be particularly important in the case of reuse of reprocessed uranium.

### **Third point : Mox fuel fabrication**

Apart the criticality risk, the main risk is the Plutonium dioxide dissemination, not only with respect to workers, but also to the environment. So it is necessary to operate the fabrication processes in tight glow-boxes.

About this subject, we get an industrial experience of many years, for example, in France with the ATPu in Cadarache which fabricated the fuel elements for fast neutron reactors Rapsodie, Phénix and Superphénix and later for PWR ; experience exist also in Belgium at the Belgonucléaire Plant and in Germany at the Hanau Plant. Up to now, no significant accident has occurred in these installations but a special attention has to be paid to prevent fire occurrence. In this case the risk of plutonium dissemination in environment would be important. So it is necessary to minimize the consequences of a fire to avoid any plutonium release. This will be the case in the new Melox french plant which is at the end of construction in Marcoule.

**ORAL CONTRIBUTION OF**

**Dr. J. TEW  
NII, United Kingdom**

**PRESENTATION OF "REPROCESSING, WASTE MANAGEMENT & DECOMMISSIONING" SECTIONS OF THE "RED BOOK" IN BRUSSELS ON 3 JUNE 1993.**

Status of Reprocessing

Spent fuel reprocessing - the separation of re-usable material from unwanted fission products - has been carried out on an industrial scale for more than 40 years. The separation technique which has become generally accepted is liquid-liquid extraction, with nitric acid as the aqueous phase and tri-butylphosphate (TBP) as the solvent phase, in the so-called PUREX process.

Worldwide more than 100,000 THM of fuel in total have been processed by this technique. By the end of 1990 more than 30,000 THM of uranium metal fuel from civil power reactors and more than 5300 THM of oxide fuel from civil LWR reactors had been processed in OECD countries. Current civil reprocessing capacities are about 5000 THM/year - rising to 7000 THM/year with THORP and new Japanese plant on stream.

In France the Marcoule plant UP1 is still reprocessing metallic fuel, whilst experience has been gained of reprocessing LWR fuels in UP2-400 and, later, UP3. A third plant is under construction at La Hague.

In the United Kingdom, the Sellafield B205 plant is expected to continue reprocessing Magnox fuel until at least 2010. The THORP plant is being commissioned, and will reprocess oxide fuels at the rate of about 1200 THM/year.

In Germany development of the Wackersdorf project was stopped in 1989, as well as the Karlsruhe plant at the end of 1990.

In Japan the pilot plant at Tokai has already processed over 600 THM, and a new, larger, plant at Rokkasho is under development.

In the United States, reprocessing of LWR fuel is presently deferred.

## Potential Hazards

All fuel cycle installations are subject to safety regulations specific to each nation, and are designed, constructed, operated and decommissioned to comply with the various regulations and requirements of the country. This is all usually controlled by licensing processes by appropriate government regulatory bodies. Many safety-related factors have to be considered, and typically these are:

### *Internal Hazards*

- ◆ Criticality
- ◆ Fire
- ◆ Explosion
- ◆ Corrosion
- ◆ Loss of containment due to leaks
- ◆ Loss of cooling
- ◆ Mechanical damage

### *External Hazards*

- ◆ Seismic events
- ◆ Extreme weather conditions
- ◆ Flooding
- ◆ Aircraft crashes
- ◆ Fire/explosion in adjacent plant
- ◆ missiles from adjacent plant
- ◆ subsidence potential from mining activities

The potential radiological risks arise from the inventory of radioactive material stored or processed.

I am sure all of you will be familiar with the various potential hazards, where they might occur and how one can minimise the risk. Therefore I will only highlight areas where fairly recent developments have occurred or where uncertainties remain to be addressed by further work.

### *Criticality*

This hazard is well understood, and methods of control/prevention are:

- Geometric control
- Mass control
- Volume control
- Concentration control
- Use of neutron poisons

Ideally all process equipment should be geometrically safe but, to increase throughput, neutron poisons are used to permit somewhat larger equipment. Criticality control problems are a lot less severe with Magnox fuel than with enriched fuels. From a criticality control point of view, cleanliness of plant and accountancy measurements are of great benefit.

Owing to the use of favourable geometries, neutron absorbers and reliable fissile material monitors no criticality accidents have so far been reported for LWR reprocessing. As we move towards higher enriched fuels and MOX, more development is needed for:

- ◆ small volume equipment providing higher specific throughput (fast contactors)
- ◆ reliable in-line concentration measurements (for lower hold-up vessel volume)
- ◆ computer aided process control (to avoid plutonium transients)

## Explosion

Build up of flammable dusts (eg. zirconium fines), gases (eg. hydrogen) or vapours (eg. solvents) can all pose explosion risks. Standard industrial measures can provide protection against these in general. The potential explosion hazard associated with zirconium fines, produced by shearing LWR fuel, received a lot of attention in the 1980s. Particle size distribution studies showed only a very small proportion of fines were small enough to present an ignition hazard in air, additionally the inerting effect from the presence of  $\text{UO}_2$  fines (by a factor of 10 to 100) suppresses dust cloud ignition. Thus the risk from zirconium dust explosions is low; nevertheless measures should aim to reduce the accumulation of fines in the shearing areas.

Within a LWR reprocessing plant there are also three potential exothermic reaction mechanisms which could lead to rapid overpressurisation or even explosions.

- i) Zirconium fines could take part in reactions with nitric acid in the dissolver and with fission product oxides. Experimental studies have shown only low self-heating rates and no violent reactions.



- ii) Hydrazine is often used in reprocessing, where it may form highly explosive hydrazoic acid and azides in a reaction catalysed by the technetium which occurs in irradiated LWR fuel. Hydrazoic acid is soluble in the solvent in the first stage contactor and is later back-extracted as sodium azide in an alkaline wash. Subsequent acidification yields free hydrazoic acid which may accumulate in cold spots in ventilation ducts and present explosion hazards. Many extensive studies in the 1980s have shown that the concentrations of hydrazoic acid in the PUREX process are insufficient to lead to explosions.
  
- iii) During the solvent extraction process small amounts of solvent may be carried over into waste streams and thence into an evaporator. The solvent and its degradation products - the so-called "red-oil" - might cause an explosion in the evaporator in a thermal runaway reaction. Studies and operational experience in the 1980s showed that the reactions in the evaporator are smooth and rapid, and do not readily develop into explosive reactions. However by minimising the carry-over of solvent, and by keeping the evaporator temperature below the appropriate limit, the potential for red-oil explosions can be eliminated.

### **Loss of Containment**

Much of the equipment providing primary containment in reprocessing is in contact with highly corrosive materials (particularly hot nitric acid, nitrous vapours, Pu (VI)) and, in some areas such as the dissolver, fine particle erosion will add to the potential to wear away the containment material. Additionally much of this primary containment is inaccessible for repair once the plant has started processing active material. Special materials have been developed to cope with this environment and operational experience has been good.

Nevertheless serious thinning of containment walls, and even leaks, do occur. During the 1980s there were many developments in the field of remotely controlled maintenance and some very active systems (eg. dissolvers and evaporators) have been successfully repaired or changed. Some particularly successful cases were at Tokai. Careful choice of materials, quality assurance of manufacture, and operation of plant under reduced pressure (where

possible) to lower the temperature and corrosion rate, can all help to minimise corrosion problems. More R&D is needed, however, into methods of remote maintenance, particularly if dose limits are reduced further.

Primary containment may have to be deliberately breached for maintenance; this results in doses to workers and presents a potential for release of radioactivity. One main aim in design has been to minimise the need for maintenance. There have been many developments in the 1980s, particularly in using high reliability fluidic devices.

## **WASTE MANAGEMENT**

Within the context of this book, waste management involves the production of wastes in reprocessing together with handling and interim storage prior to disposal. The main objective is to prevent undue radiation exposure to man and contamination of the environment.

### **High Level Liquid Waste**

This is a mixture of nitrates in nitric acid solution containing more than 99% of the non-gaseous fission products from the fuel. To provide a safe HLLW store requires reliable containment and cooling. A safety assessment must include detailed studies of site ecology, external hazards and environmental impact.

Since the 1950s the design and operation of storage tanks have improved a lot. A typical modern tank contains about  $10^7$  TBq in  $100\text{m}^3$ ; multiple cooling coils and diverse water supplies are provided to give good reliability for heat removal; an agitation system prevents solids settling and making corrosive hot spots; spare tanks and pumps are provided to transfer the contents in the event of a leak. Leak detection systems are, of course, provided.

Experimental and theoretical studies of the effects of loss of cooling were carried out in the 1980s, and it seems clear that several days without any cooling would have to elapse before even a small tank would start to boil down to dryness. Remedial action could easily be taken in that period. The probability of the loss of cooling lasting that long is extremely low.

## **High Level Solid Wastes**

Generally storage of HALW in tanks is now considered an interim measure, and conversion into a stable solid form is a necessary step for safe long-term storage and disposal. The currently accepted method for immobilisation is to vitrify the waste (ie. incorporation of fission products in a glass matrix). This is chosen because it can be made safely and easily, and it offers excellent resistance to environmental influences.

The industrial facilities in France and UK commissioned in the last decade, are based on the French AVM process, where HALW is calcined before being mixed with glass. An alternative process was developed in Germany, where HALW was directly added to glass, and a plant PAMELA built at Mol.

A third process 'SYNROC' is still being evaluated. Here the HALW is incorporated into a matrix of Zr, Ti and Ba oxides under pressure and at 1200°C. The result is a synthetic rock, hence the name, which is thermodynamically stable in geological strata. The engineering aspects still require further development, as the conditions of formation are quite severe.

A common feature of all these methods is that they require high temperatures and thus the volatile radionuclides are driven off and require extensive air-cleaning facilities to remove them. Values of DFs for AVM and PAMELA in the 1980s have shown that the environmental impact is acceptable, provided the air cleaners are operating well.

There have been major advances in terms of remote maintenance in connection with these processes.

## **Fuel Cladding Wastes**

These comprise fuel cladding, structural components and solid residues. Whilst interim storage of these poses no new problems, the longer term view is uncertain. Insoluble residues can be embedded in concrete or vitrified with HALW. Fuel cladding can be embedded in concrete (as in the UK) or in bitumen. The difficulty is that all these processes tend to increase the volume of waste finally generated.

Some R&D started in the 1980s to look at volume reduction or minimisation methods, such as compaction and melting and incorporation in glasses, and it is hoped this work will continue to produce results.

### **Medium Active (and PCM) Wastes**

MA waste solutions are either concentrated and vitrified, or chemically treated to produce precipitates which are stored in cement (UK) or bitumen (France). Potential hazards are fire and radiolytic hydrogen generation, but preventive measures are readily available to cope with such incidents.

Solid plutonium contaminated waste arises at most stages of reprocessing - usually as paper, rubber and equipment. Methods of volume reduction include compaction, incineration, electropolishing and acid digestion, but generally these have not yet proceeded beyond pilot plant (or low throughput) stage and more engineering development work is needed.

The volume of spent solvents can be minimised by process control and solvent washing, but a certain fraction remains. Different methods of treating this have been proposed - incineration, pyrolysis, oxidation etc. - but none have developed beyond the pilot stage yet.

### **Gaseous Wastes**

Gaseous nuclides are released during fuel shearing and dissolution:

- ◆ Tritium and carbon-14
- ◆ Krypton-85
- ◆ Iodine isotopes

About half the tritium ends up in aqueous effluents and in the 1980s successful pilot studies developed a process for its removal. The rest of the tritium remains with the fuel cladding as  $ZrH_2$ . About 60% of the C-14 is released as  $CO_2$ ; it can be scrubbed out and precipitated as  $Ba CO_3$  (as it will be in THORP).

Iodine is the only volatile nuclide which is generally trapped in off-gas plants - either in alkaline scrubbers or on silver absorbents.

A lot of work has been done on the removal of Kr85 but the processes were technically very complex and not without their own hazards. The environmental impact of Kr85 was assessed in the EEC and shown to be insignificant, so Kr retention is presently not favoured.

### **Decommissioning**

As in the case of many conventional plants, much can be done to safely extend the lifetime of a nuclear plant. However a point will come when it is judged to be no longer economic or safe to keep the plant running. Environmental standards are now starting to demand that shutdown plant or sites be rendered safe and left in a visually acceptable state. A responsible nuclear industry must deal with this end of lifetime (ie. decommissioning) in a publicly acceptable manner.

In the last decade there has been an increased emphasis on planning and methodology of decommissioning, and many conferences held. Both the EEC and OECD/NEA have been involved in supporting collaborative decommissioning projects.

The overriding safety considerations are aimed at keeping worker doses as low as reasonably achievable. A lot of useful experience has already been gained and there have been no major incidents.

### **Conclusion**

Spent fuel reprocessing is a major fuel-cycle option in a number of countries, and is expanding in some countries. The safety record has been excellent over the past decade, and newer and even potentially safer technologies are being developed. The major challenges to face the industry over the next decade at least must be in my view (1) disposal of waste and (2) decommissioning of old plants.

A/T/Doc5/03.93

**ORAL CONTRIBUTION OF**

**Dr. M. BROWN  
AEA, United Kingdom**



AEA Technology  
Consultancy Services  
(SRD)

**DRAFT CONTRIBUTION TO BNS SYMPOSIUM PROCEEDINGS  
3-5 JUNE 1993**

**SAFETY OF THE NUCLEAR FUEL CYCLE REPORT PRESENTATION  
CONCLUSIONS AND RECOMMENDATIONS FOR FURTHER WORK**

**THE FRONT END OF THE FUEL CYCLE**

Over the period since the last report there have been only minor changes in industrial process. Metallic fuels have become somewhat less significant and oxide fuels the most prevalent; and mixed oxide fuel has started to be more extensively used for plutonium B cycle in LWRs. Generally the changes are not great.

**URANIUM EXTRACTION**

Whilst methods have not changed, new issues have arisen. On the side of worker safety radiological criteria have become tighter and richer ores have been discovered. Worker safety in such mines is now a challenge that can only be addressed by a change in technology to remote working.

On the environmental side there has been an increasing concentration on environmental impact issues in particular the impact of mill tailings. Geochemical stabilisation of existing spoils is of concern in a number of countries.

**ENRICHMENT**

The large scale industrial processes of diffusion and centrifuge enrichment are now well established and are proving themselves as reliable and safe technologies.

Safety analysis has moved on since the last report and in particular external hazards have been more extensively reviewed. This has confirmed the design adequacy of enrichment plants.

Under extreme accident conditions, particularly a large scale fire, the toxic impact of the large inventory of residues in storage could prove a problem. This is addressed by siting measures and protection.

**FUEL FABRICATION**

Major industrial use is made of dry processes of fuel fabrication although wet processes must now be regarded as proven also.

The major hazard at this stage is accidental criticality and no criticality incidents have occurred. Indeed there are few incidents reported generally for this stage of the front end of the fuel cycle.

**MIXED OXIDE FUEL**

Fast reactor fuel fabrication is now well proven and mixed oxide recycle in LWRs increasing.



There are additional problems posed by recycle of plutonium particularly where plutonium is of a disadvantageous isotopic composition and has been stored for a time, leading to an increase in the gamma dose from americium.

## **THE CENTRAL PART OF THE FUEL CYCLE - REPROCESSING**

Gas cooled reactor and water reactor reprocessing has now been demonstrated internationally at very large scale plants notably in France, the UK and soon also Japan. Whilst there have been some problems in the UK related to the processing of MAGNOX reactor fuel, these have been largely due to deterioration of such fuel in storage ponds and not an intrinsic difficulty with the process itself. Those problems have now been solved and reprocessing must be regarded as an established industrial activity.

It is worth noting that large scale pond storage is generally associated with reprocessing. Dry storage has also been successfully introduced in a number of countries particularly through the use of transport casks performing the dual function of transport and storage.

A number of utilities are known to be considering the use of dry storage as an alternative to reprocessing but this is due to economic considerations, not safety issues.

## **WASTE STREAMS**

### **High Level Waste**

At the time of the last report the storage of high level waste in liquid form was felt to be of concern. Time, experience, and improved safety analysis has reduced this concern and although the waste generates heat the diversity of cooling and contingency measures are now shown to be very robust.

Vitrification is now proven at an industrial scale and is in use routinely. The interim storage of such vitrified waste is essentially intrinsically safe.

### **Other Waste Streams**

Waste stream treatments have undergone steady improvement and there has been a reduction in effluents at most operating plants.

As far as solid wastes are concerned the immobilisation of residues in bitumen and cement continues and whilst there are some issues related largely to interim storage they are second order ones from a safety viewpoint. Final disposal is outside the scope of the report.

## **SAFETY ISSUES**

Turning to safety issues generally, in principle these come from the dispersible nature of the material involved in fuel cycle operations. However there is no major energy source, such as in a reactor, capable of driving the dispersion of material so in general risks are lower and smaller scale than for the associated reactor technology. Taking some of the risks in turn:



AEA Technology  
Consultancy Services  
(SRD)

Fires, explosions and criticalities are all dispersive events that have proven engineering solutions. Experience, test and analysis has developed in support of these.

As far as external events are concerned these are more often extreme happenings such as aircraft crash. Direct data do not exist but considerable work has now been done using crash data, dispersion data, etc to perform risk analyses. These have shown that through a combination of site selection and protection even extreme external events can be managed such as to have limited radiological consequences.

In operating plants corrosion has proved to be a problem in a number of instances. Experience has evolved however and selection of materials is now better developed, as are techniques for repair of faulty or failed equipment by remote handling.

Learning from incidents has become more of a feature and the INES safety scale has been adapted for use in fuel cycle incidents. There is probably still some way to go in maximising the benefit to be gained from mutual knowledge of incidents however and it is to this end that the FINAS reporting scheme has been introduced.

Control and instrumentation monitoring has evolved since the last report but has only relatively recently adopted the more advanced elements of software control for example, expert systems. This is an area where safety advances may be expected.

## SAFETY PHILOSOPHY

In terms of overall philosophy, the ALARA concept is now in almost universal use.

So is the principle of defence in depth where more than one barrier, procedural or physical, needs to fail before undesirable consequences occur.

Allied to defence in depth is the consequence assessment and contingency planning to cope with the very unlikely cases where all barriers do fail. This again is now an accepted element of philosophy in all countries.

## FUTURE DIRECTIONS

In summary future directions are perceived as being as follows.

In mining the issues of radon in rich ore mines, and mine tailings in the environment will become of increasing interest.

In fabrication mixed oxide fuels for plutonium recycling in LWRs will require new solutions or adaptations.

In reprocessing the reduction of waste streams will feature as will decontamination and conditioning of solids to reduce volume and activity of wastes. Decommissioning of plants overall will become a more common experience and more commonly designed for. There are also issues associated with safe handling of mixed oxide fuel going through several cycles of reprocessing, with consequent



AEA Technology  
Consultancy Services  
(SRD)

change in radiological hazard.

In the area of wastes the question of waste reduction and intermediate storage prior to disposal is of some importance particularly where disposal is delayed. Disposal itself is outside the brief of this study.

## CONCLUSIONS

Without wishing to seem complacent, the overall conclusion is that the technology is mature and environmental impact controlled. Future developments are likely to yield a more efficient use of materials and resources and in accordance with the ALARP principle an improvement in safety and impact where this can be reasonably achieved.

A handwritten signature in black ink, appearing to read 'M L Brown', written in a cursive style.

*R* M L BROWN

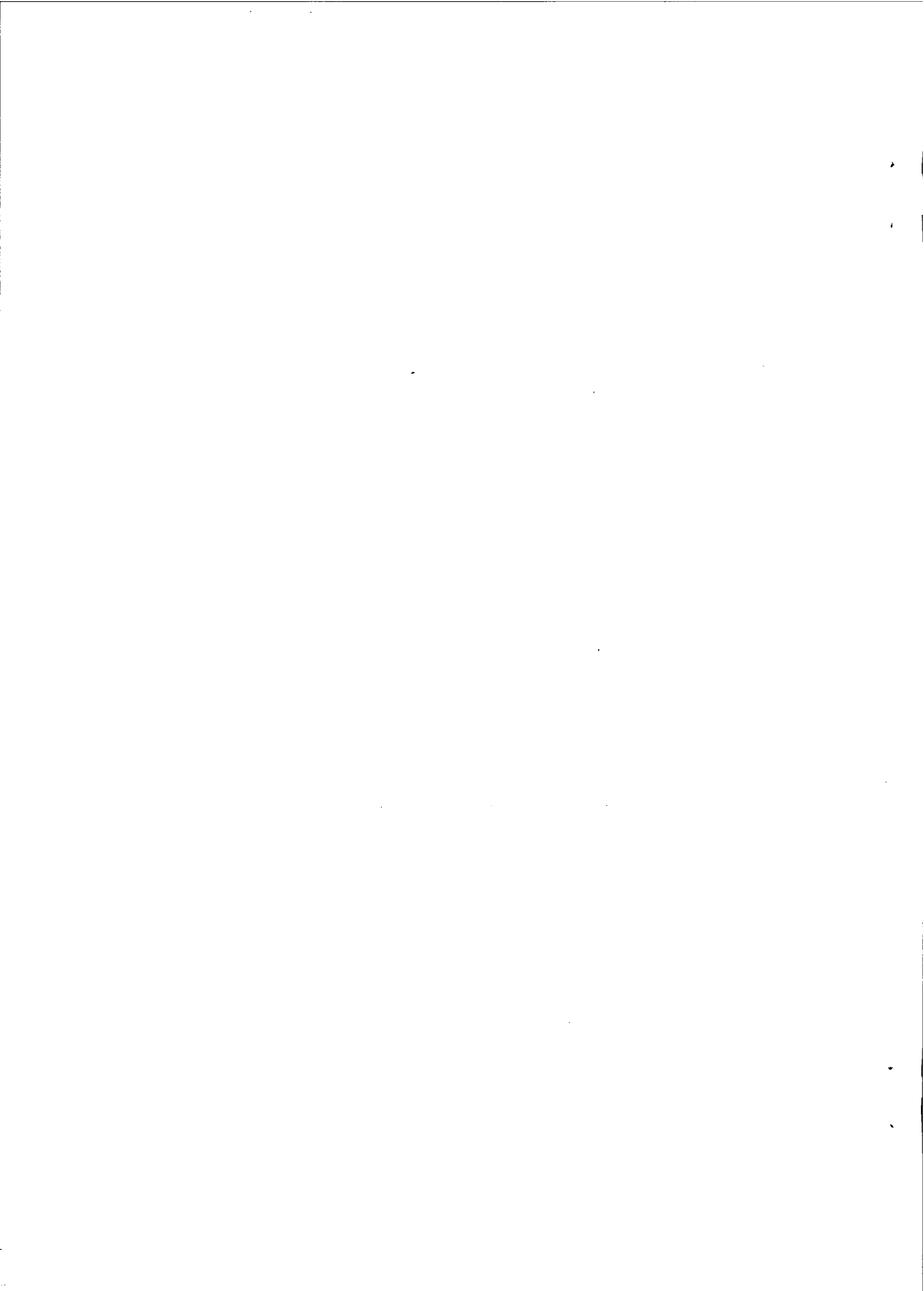

**SAFETY OF  
URANIUM MINING OPERATIONS  
IN CANADA**

**T. Viglasky  
Uranium Facilities Division  
Atomic Energy Control Board**

**June 1983**

# **SAFETY OF URANIUM MINING OPERATIONS IN CANADA**

## **BACKGROUND**

Currently, there are three licensed operating uranium mines located in northern Saskatchewan. Workers are on a seven-day in and seven-day out schedule. Air transport is used.

The uranium is transported by truck [12-hour trip to Saskatoon].

Total remaining mineable reserves are approximately 5.0 M tonnes, grading between 0.60 and 1.7%  $U_3O_8$  [15 to 40 lbs/t].

Proposals to extend the life of the three existing operations [one mining and two milling] by exploiting new ore zones and to develop three distinctly new uranium mining operations, are presently undergoing an *Environmental Assessment Review Process* [EARP] and public hearings.

Total potential mineable reserves for the proposed activities are approximately 9.0 M tonnes - grading between 1.40 and 9.25%  $U_3O_8$  [30 to 200 lbs/t].

Exploratory diamond drilling has intersected ore zones 10 to 40 m in width grading 10 to 60%  $U_3O_8$  [220 to 1320 lbs/t]. In one instance an ore lens approximately 1 m in width graded 80%  $U_3O_8$  [1760 lbs/t]. Across 20 m it graded 50%  $U_3O_8$  [1100 lbs/t].

200 m long by 50 m wide by 25 m thick lenses near surface to 1100 m long by 300 m wide by 400 m thick elongated zones 500 m underground are typical of the ore body dimensions encountered.

Cigar Lake 20 to 100 m wide, and 2150 m long, and 7 to 20 m thick.

## **GEOLOGY AND MINING METHODS**

In northern Saskatchewan the uranium bearing mineralized zones are found in scattered high-grade discrete, sub-vertical structures, steep to relatively flat lenses, pods and vein-type formations located near surface to as much as 600 m below surface.

As a result, open pit operations were developed initially, commencing in 1975, with underground development commencing in 1983.

While open pit designs were basically conventional in design, innovative mining methods had to be devised and tested in order to be able to conduct safe underground mining activities in high-grade uranium ores.

Open pits are excavated to varying dimensions, for example:

- Rabbit Lake pit .. 550 m x 425 m x d 125 m;
- B-Zone pit [Rabbit Lake] .. 600 m x 350 m x d 65 m;
- Deilmann pit [Key Lake] .. 1000 m x 800 m x d 200 m.

## OPEN PIT MINING

If the ore body is within 200 m from the surface, and large enough, it is likely that an "open pit" extraction method will be utilized.

In an open pit operation, with average grades ranging from 1% to 6%  $U_3O_8$ , the following radioactive hazards must be evaluated and mitigative actions taken:

### o *Radon Progeny*

- \* Under normal circumstances, natural wind currents will flush out the open pit and keep radon progeny concentration levels acceptable, that is < 0.05 WL.
- \* However when wind velocities fall below normal levels or a "temperature inversion" occurs [when warmer air overlays colder air within the pit] the flushing action is minimized and radon progeny concentration levels will increase. Under these conditions it is not unusual to measure levels ranging from 1.0 to > 3.0 WLs.

When this occurs the only solution that has been used is to remove the workers from the pit until weather conditions normalize.

By implementing appropriate safety and protective measures, 90% of open pit miners receive radon progeny exposures of < 0.30 WLM/yr. A maximum exposure recorded was 0.80 WLM.

### o *Gamma Radiation*

- \* Average ore grade ranges between 1% and 6%  $U_3O_8$ . Zones of between 10% and 40%  $U_3O_8$  will be encountered.

Assuming a dose rate of 5.0 mR/hr per % U, workers could be working within gamma fields of 5.0 to 200 mR/hr on any given occasion.

However, again by observing appropriate safety and protective procedures 90% of open pit workers received a gamma dose of  $< 2.0$  mSv/yr. A maximum dose recorded was 7.8 mSv.

- \* There is very little flexibility in an open pit design that will offer a significant or constant degree of protection to the worker. Rather, operating methods and procedures must be developed and implemented that optimize:

- 1) minimizing the time of worker exposure;
- 2) maximizing the worker distance from the source;
- 3) utilization of shielding.

- \* CONSIDERATIONS

- Provide each worker a personal gamma dosimeter.
- Conduct field monitoring surveys at appropriate frequencies.
- Install shielded operator cabs with filtered fresh air systems on operating equipment.
- Utilize remote controlled equipment.
- Use inert material to provide shielding, e.g. bench drilling when equipment is directly on top of ore body.
- Develop drill patterns requiring the least number of holes.
- Utilize smaller blasts to minimize volume of exposed broken ore.
- Fully train workers so that rotation within different operating functions is feasible.

- o *Long-lived Radioactive Dust*

- \* Worker exposure to airborne radioactive dust will be a risk factor that will vary depending on many conditions. Some, like wind velocities and direction, humidity, and levels of rainfall, can not be controlled by the operator. As a result, solutions for all eventualities must be considered.

- \* CONSIDERATIONS

- Locate equipment operators within pressurized cabs where all air supplied is filtered.



- Use personal respirators outside of pressurized cabs.
- Utilize smaller blasts to reduce volume of broken ore and associated dust.
- Co-ordinate wind conditions and blast location to minimize dispersal of dust over occupied areas.
- Use water sprays to wet down broken ore after each blast.
- Wet down broken ore piles and travel routes during load and haul activities.
- Consider prevailing winds when developing open pit design and layout.
- Consider "wind breaks" [natural or constructed] in strategic locations around the open pit perimeter to minimize gusting and the creation of airborne dust. [This must be balanced with the need for natural airflows required to prevent the buildup of radon progeny].
- Locate overburden, waste and ore stockpiles in locations that take into account prevailing winds and minimize uncontrolled dispersal of airborne dusts.

## UNDERGROUND MINING

- o For approximately 35 years, Elliot Lake, Ontario was the center for uranium mining in Canada.

As the uranium mineralization was found in flatly-dipping, terraced, pyritic quartz-pebble conglomerate beds extending from surface to 1150 m in depth, the "room and pillar" mining method was used exclusively at the twelve mines that operated in the area since 1955.

Ore grades ranged between 0.1 and 0.15%  $U_3O_8$ . Currently, only the Rio Algom Ltd. Stanleigh Mine continues to operate, mining uranium at less than 0.1%  $U_3O_8$ .

There was no surface "open pit" mining done in Elliot Lake.

- o Neither the current nor proposed uranium mining operations in northern Saskatchewan utilize the "room and pillar" mining method.
- o If the grade of a mineable ore zone does not exceed 0.5%  $U_3O_8$ , [estimated gamma dose rate of 2.5 mR/hr] the determination of an appropriate mining method could position the worker in close proximity or within the ore zone itself.

- o Once a grade exceeding 0.5%  $U_3O_8$  for a mineable ore zone is determined, it is incumbent upon the operator to develop a mining method that will provide the maximum radiological protection to all the workers in the underground environment by optimizing the benefits of:
  - 1) limiting exposure time of worker to the hazard;
  - 2) distancing the worker from the hazard source;
  - 3) shielding of the worker.

- o *Gamma Radiation*

- \* Full-scale development or production activities actually working "within" mineable ore zones that exceed a grade of 0.5%  $U_3O_8$  [2.5 mR/hr approximate dose rate] is unlikely to receive regulatory approval to proceed.

With the encroaching promulgation of the amended *Atomic Energy Control Regulations*, which includes the combination formula, it is likely that, in the future, the above guideline will be considered too liberal.

- \* However, since none of the existing or proposed underground operations are intending to mine grades  $< 0.5\%$   $U_3O_8$ , the previous consideration does not currently apply.

- \* CONSIDERATIONS

- Select or devise a non-entry mining method that will shield and distance the worker from the actual ore zone being mined: for example, familiar methods such as "vertical blast-hole stoping" emphasizing non-entry procedures together with an increased use of remote controlled mining equipment; and innovative methods using rock boring or jet boring to remotely grind or flush out the ore.

The jet-boring method is being considered at Cigar Lake. This innovative approach to mining uranium would result in the ore being removed in a slurry form, ground-up underground, and pumped to the mill. All this would take place in containment to prevent the release of uranium dusts and radon daughters.

Cigar Lake has indicated that it plans to use a 15%  $U_3O_8$  mill feed for the first 20 years of its operation.

- "Test mine" programs must be carried out that will allow the field evaluation of modified or innovative mining methods.
- Mining method could have a significant effect on percentage of the ore zone recovered. This could vary from 65% to 95%.

- The use of relatively inert waste rock in place as a barrier/shield in developing mining plans should be maximized.
  - Gamma dose rates will likely be highest where broken ore is collected for transport from stope drawpoints. Dose rates ranging between 5.0 and 50.0 mR/hr in an uncontrolled situation would not be unexpected. Sealed chutes might be feasible.
  - Mobile haulage equipment or fixed conveyor systems are to be fitted with covers to prevent spillage.
  - All operator controlled mining equipment is to be fitted with cabs to provide shielding to the worker.
  - Haulage equipment is to be designed so as to separate the operator cab from the ore container.
  - Mining equipment will break-down. It is very unlikely that it will do so in either an uncontaminated state or in a location isolated from a potentially high radiation source. Methods must be developed and workers be thoroughly trained in approved salvage and maintenance procedures so as to minimize their exposure to radiation.
  - Housekeeping must be intensified. Draw points, haulage routes, sumps, equipment repair bays must be regularly monitored and cleaned up.
  - As with everything, when equipment operates as designed, the hazards to the workers will be minimal. Most of the safety assessments will deal with upset and accident situations, and radiation control during maintenance activities.
- o *Radon Progeny*
- \* Radon progeny will be introduced to the underground workplace by inflows of ground water containing radon, and by emanation from radioactive ores exposed by mining activities.
  - \* Inflows of groundwater into underground workings at a rate of 100 m<sup>3</sup>/h [1650 L/min - 365 IGPM] have been expected. Assuming 75% of water is derived from sandstone, 22.5% derived from the altered zones around the ore body and only 2.5% of the water derived from the ore zone, the expected radon influx could be 6.0 x 10<sup>9</sup> pCi/h. For example at one underground operation the radon progeny concentration rose to 120 Working Levels in approximately 2 hours after the only installed underground ventilation system failed.

\* CONSIDERATIONS

- Workers could be issued personal alpha dosimeters [PAD].
- Environmental sampling programs at appropriate frequencies should be conducted.
- Engineered ventilation systems should be installed and all workers trained in correct operational and maintenance procedures. "Single-pass air" ventilation systems are preferred.
- Emergency backup systems and alternative power sources should be available in the event of the primary system failure.
- Emergency response and evacuation training is to be provided to all the workers.
- The use of fragile ventilation ducts should be minimized and replaced with strategically located permanent air corridors. For example, 1.5 m diameter bore holes are currently being driven as flat as  $< 2$  degrees for the purpose of routing intake or exhaust ventilating air volumes.
- Continuous radon progeny concentration monitors, fitted with visual and/or audio alarms, are installed at strategic locations throughout the underground workings.
- The potential inflow of groundwaters into the development and production areas is to be determined by use of exploratory drilling programs ascertaining conditions ahead of advance. When groundwater is encountered, the following options can be considered:
  - 1) install a plug, with valve, in the collar of the drill hole and drain and direct water to prepared sumps via an enclosed piping system - not open ditches;
  - 2) pump in "grout" to seal off groundwater inflows into excavated workings;
  - 3) using recognized technology, "freeze" the ground, prior to excavation, to form a protective ice barrier around the zone of activity. This action also has the added benefit of improving ground stability.

o ***Long-lived Radioactive Dust***

All facets of the mining cycle create dust: for example, drilling, blasting, loading, hauling and dumping.

In a high-grade uranium mine the mitigative actions considered and taken come under a high degree of scrutiny.

\* **CONSIDERATIONS**

- The design of ventilation systems must minimize the transport of airborne dusts to populated areas. Intake and exhaust corridors must be segregated.
- Access ramps from surface to the underground workings often serve entirely or partially as exhaust corridors. As a result all vehicular traffic, including ore haulage equipment, travels within a contaminated environment. Options must be reviewed.
- The use of water sprays and atomizers on travelways and mining workplaces must be encouraged - even though this does increase the volume of mine water that must be handled and treated.
- Only wet drilling activities will be allowed.
- Protective equipment, such as air-stream helmets, dust masks, and respirators, must be readily available to workers.
- Only filtered air is to be supplied to workers located in sealed cabs of operating equipment.

**ENVIRONMENTAL CONCERNS - SURFACE**

- o Contaminants are introduced to the surface environment through the medium of liquid or gaseous effluents.

Minimize the discharge of either and the potential for environmental damage will also be minimized; for example, radioactive airborne dusts from: open pit blasts, dry roads, open haulage truck boxes, surface storage of overburden, broken waste and ore stockpiles, and dry tailings, ventilation exhaust raises and ramps from underground workings, stack discharges from the mill. Further examples include radioactive liquid discharges from: open pit and mine waters, mill process water, tailings, natural waters percolating through a variety of stockpiles, spills contaminated groundwaters.

- o The storage of tailings has technically evolved significantly, and continues to evolve, in the last 35 years.

Originally, uranium tailings were treated no differently than the tailings of any base metal or precious metal mine anywhere in Canada, i.e., a nearby lake or basin where discharge could be controlled using the natural topography and by strategically located dykes and dams.

- The total  $U_3O_8$  produced in the Elliot Lake, Ontario region since the mid-1950's is approximately 450 m lbs.
- The "above ground" Key Lake constructed tailings management area is 600 m x 600 m in size and is designed to accommodate tailings to a height of 25 m. The total design holding capacity is 4.9 M tonnes of solid tailings.

Currently, the waste management systems required to service the uranium operations in northern Saskatchewan are considered to be the "state of the art" in Canadian mining.

- o Mine tailings are now being stored or disposed of in:
  - a) excavated underground workings;
  - b) completed open pits utilizing the "pervious surround" method;
  - c) fully constructed and lined surface tailings ponds covered with water.
- o The surface storage of waste rock has become a matter of significant review by the regulatory agencies in Canada.

On a site specific basis waste/ore cut off grades were set at such values as 0.03%, 0.05% and 0.10%  $U_3O_8$ . The presence of other metals or mineralization was a secondary consideration in making the "waste" designation.

Currently, the presence of other substances is being considered equally as important [or more so] due to the acid generating or toxic effects that could be discharged to the receiving environment.

Radiological impacts on the public are estimated to be 1 - 2  $\mu$ Sv per year.

Of concern are contaminants such as sulphides, arsenic and nickel.

Ore, grading 5.75%  $U_3O_8$  was located with an "arsenic" content of 1.45% and a "nickel" content of 2.3%.

The operators are being asked to develop "waste rock sampling programs" that will assist in the development of improved, classified storage facilities for waste on the surface.

## MILLING

- o The common belief that radiological hazards in a mill that processes high-grade ores [15%  $U_3O_8$  being considered at one Saskatchewan facility] significantly surpass the hazards present in a mill processing low-grade ore [0.1%  $U_3O_8$ ] is only partially valid.

Once the precipitation stage of the milling process is reached in either situation, the radiological risk to the workers in the event of an upset condition is relatively comparable.

However, at the input stage where high-grade ore is first deposited into the process and throughout the initial stages of the milling circuit, gamma fields in the vicinity of exposed crushed ore could reach levels as high as 75 mR/hr. Equally of concern are the operations which separate the uranium from other radionuclides.

### \* CONSIDERATIONS

- The crushing, grinding and milling circuit must be sealed as much as practicable to minimize direct exposure to ore or process solutions.
- At strategic locations exhaust systems must be designed into the process stream.
- The mill complex must include a designed intake/exhaust ventilation system that will accommodate seasonal variations.
- Properly designed sumps must be located at every stage of the process. Clean-out procedures should accommodate a worker non-entry objective whenever possible.
- Sumps should be serviced by portable, removable pumps. Auxiliary and by-pass options are to be designed into the maintenance process.
- A risk assessment analysis of each critical component phase in the milling process must be conducted and then emergency response procedures must be developed to address critical upset conditions.
- An adequate supply of protective equipment has to be on hand so that any operational, maintenance and emergency situation can be safely addressed.

- o Testing of new innovative or modified mining methods, as well as remote controlled mining and ore handling equipment, and state of the art ventilation, monitoring and communications systems is often carried out by the operators before being fully incorporated into the final operational plans.

The regulatory agencies generally support the concept of "test mining programs" and monitor them very closely.



**BNS/OECD - NEA SYMPOSIUM ON THE  
SAFETY OF THE NUCLEAR FUEL CYCLE**

**BRUSSELS, 3-4 June 1993**

**HEALTH PHYSICS ASPECTS OF URANIUM MINING  
IN FRANCE**

S. BERNHARD, *Centre de Radioprotection dans les Mines, Société ALGADE*  
(Groupe COGEMA) - BP 46 - 87250 Bessines-sur-Gartempe

---

**ABSTRACT**

New regulations concerning the radioprotection of mine workers was introduced in July 1989 in the French Mining Code. Its take into account recommendations of the CIPR n° 26 and resulting European directives, concerning both the limitation of individual doses and the optimization of radioprotection.

Efforts undertaken for the past several years in terms of the quality of dosimetric monitoring of workers and the implantation of preventive measures have enabled the total effective dose of 50 mSv per year to be respected in French mines.

The perspectives for improved quality of radiological protection in French subterranean mines are examined in order to be able to respond to a new increase of the severity of individual limits recommended by the CIPR n° 60.

## 1. INTRODUCTION

In an uranium mine, miners are essentially exposed to radiation emitted by eight radionuclide alpha emitters and by the six radionuclide beta emitters of the uranium 238 series.

Miners are exposed to two types of radiological risks.

The first is the result of external exposure to gamma rays, 83 % of the energy of radiation coming from bismuth 214 and 12 % from lead 214, both short-lived decay products of radon 222. The second of internal exposure is due to absorption of alpha transmitters in suspension in the atmosphere in the mine :

- radon (222 and 220) and radon daughters, which are short-lived alpha emitters,
- fine ore dust carrying long-lived alpha emitters of the uranium chain (U 238, U 234, Th 230, Ra 226, Po 210).

Among the decay products of uranium 238 is radon 222, a rare gaz likely to migrate through rocks and pollute the atmosphere. Inhaling radon itself normally only causes negligible danger compared with that caused by inhaling its descendants present in the air : polonium 218, lead 214 and bismuth 214, either in the free ion state, or fixed on mine aerosols, settle in the lungs and leave a large part of their potential alpha decay energy (PAE).

The second source of internal exposure resulting from inhaling fine mineral dust carrying long-lived alpha emitters can become significant in relation to the annual limits on very dusty stopes, or ones where the uranium content of the mineral exceeds 0.5% and may become preponderant in certain cases such as in opencast mines in areas with dry climates, and in mineral processing plants.

## 2. THE STATUTORY CONTEXT IN FRANCE

The recommendations of the International Commission of Radiological Protection (ICRP No. 26 and derivative publications) which were adopted by the European directives of the 15th of July 1980 and the 3rd of September 1984, were adopted into French legislation by a ministerial decree (decree No. 89-502 of the 13th of July 1989) introducing requirements for the protection of workers against ionizing radiation into the Règlement Général des Industries Extractives.

This regulation has been in force since the 20th of January 1990 in all French underground and open-sit mines whether or not they are working radioactive substances.

The main technical characteristic of this regulation is that the exposure monitoring of personnel and the monitoring of the radioactive atmospheres at the work stations are handled using to specifically laid down procedures and equipment.

### 2.1. Personal exposure strategy

The French regulations require the following systems to be implemented :

- individual dosimetry for workers likely to be subjected to an annual dose greater than 3/10ths of the statutory limit ;

- function dosimetry for checking operators likely to be subjected to an annual rate of exposure between 1/10th and 3/10ths of the statutory limit.

Operators likely to be subjected to annual exposure of less than 1/10th of the annual limit are considered not to be exposed to ionizing rays and are not monitored. It is only necessary to check the working environment in order to ensure that the 1/10th of the statutory limit is respected.

These are the requirements applicable for radiological surveillance of French uranium miners :

- individual dosimetry for operators working in underground mines, based on the use of equipment worn by operators during their working period enabling continuous measurement, during one month of the exposure to which each worker is subjected ;
- function dosimetry for operators working in open-sit mines, based on the use of equipment worn by a sample of workers representing different functions occurring in the operation concerned.

For non-uranium bearing underground mines, the French regulations require that the mines should be investigated to determine which of them should be subject to radiological monitoring, that is those in which workers may receive equivalents of annual exposure doses greater than the 1/10th of the statutory limit. These investigations are directed especially onto concentrations of radon 222 in the general air return circuits from these mines. A value of 400 Bq.m<sup>-3</sup> on the air return circuits has been adopted in the French regulations. This concentration is that above which it is necessary to carry out more accurate studies on any possible health hazards to the workers concerned.

## 2.2. Statutory individual limits

In uranium mines we are in the situation of combined internal and external exposure, as the miner receives doses due to gamma rays (external exposure) and inhaling radioactive aerosol alpha transmitters (internal exposure) by mineral dust and of course short-lived radon decay products.

In addition, an annual limit taking into account the combined risks must be respected. It should give a satisfactory result to the following formula :

$$(1) \frac{\gamma}{50 \text{ mSv}} + \frac{\text{PAE Rn 222}}{20 \text{ mJ}} + \frac{\text{PAE Rn 220}}{60 \text{ mJ}} + \frac{P \cdot ore}{1700 \text{ Bq}} < 1$$

with:

Gamma = the annual dose of external exposure in mSv

PAE Rn 222 and PAE Rn 220 = potential annual inhaled alpha energy from short-lived decay products of radon 220 and 222 isotopes, in mJ

P = total activity of long-lived alpha emitters of the uranium chain, inhaled annually in Bq

This formula is called the Total Annual Exposure Rate "TAER".

### 3. INDIVIDUAL EXPOSURE MONITORING IN FRENCH URANIUM MINES

Dosimetry of uranium miners in France is based upon the use of a personal dosimeter developed by the Centre de RadioProtection dans les Mines of ALGADE. This exposure sensor was designed to check exposure due to the potential alpha energy of short-lived decay products of radon 222 and 220, but it also allows monitoring of the two other dangers, that of external exposure due to gamma rays and internal exposure due to the inhaling of long life alpha transmitters present in the mine aerosol.

The individual dosimeter is a device weighing about 300 g (dimensions : 85 x 62 x 79 mm) consisting of a centrifugal pump with a rated output of 5 l.h<sup>-1</sup>, a battery supply for the pump (battery life more than 12 hours, and recharged by induction as soon as the instrument is placed in its charging unit) and a measuring head consisting of a light alloy body containing sensors measuring exposure.

At present about 950 instruments are in use every month in all French uranium mines and on some installations affected by risks connected with radioactive dust. A total of about 2,000 individual dosimeters are worn each month in the world by workers in installations (mines or ore-processing plants) concerned by radiological problems connected with uranium or thorium chains in Gabon, Niger, Canada, Germany, Spain and Australia.

#### 3.1. Measurement of internal exposure

The air sampled by the exposure meter at the measuring head passes through a 1.2  $\mu\text{m}$  porosity filter diaphragm which traps the aerosols present in the air in the mine, and especially the alpha transmitting radionuclides. The short-lived alpha emitters, radon 222 and radon 220 daughters, break up on the filter. The alphas normally transmitted at the surface of the filter cross the collimators and are slowed down selectively depending on their energy emission before being absorbed on sensitive detector film surfaces (Kodak LR 115 type III cellulose nitrate).

After the dosimeter has been worn for one month, the measuring head is sent to the laboratory :

- after development in a soda bath, the cellulose nitrate shows up traces corresponding with alpha transmissions of Po 218, Po 214, Bi 212, Po 212 and Rn 222. The number of traces recorded on each of the surfaces enables the monthly exposure to potential alpha energy due to radon 222 and 220 decay products received by the wearer of the dosimeter to be calculated ;
- when the head is dismantled, the 1.2  $\mu\text{m}$  filter diaphragm is extracted and subjected to an alpha count (with a photomultiplier and scintillator) to measure the activity of the long-lived alpha emitter aerosols.

#### 3.2. Measuring external exposure

The top part of the measuring head is closed by a badge containing two lithium fluoride pellets. These are thermoluminescent exposure meters which record the equivalence of the dose mainly due to gamma rays to which the workers are subjected.

### 3.3. Exposure received by workers in 1992

For the five operations presented, which extract about 2,000 tons of uranium per year with an average grade of about 0.4 %, we can see that the annual average total exposure rate, representing the combination of different types of exposure, ranges from 0.19 to 0.26 TAER. Not one of the 723 checked workers of uranium mines in France received an annual exposure rate greater than 0.62.

Nevertheless the risk of exceeding the individual limits over a period of 12 months remains high in underground mines and the respect of the French regulations still requires great vigilance on the part of radioprotection staff and a constant effort by the operators.

## 4. PREVENTION OF RADIOLOGICAL RISKS

With the introduction of individual alpha exposure monitoring, the two functions of dosimetric monitoring of workers and of fulfilling prevention tasks are now completely separate. Individual exposure levels are supplied directly by exposure sensors worn by the worker and in this way, the radioprotection teams can spend most of their time in prevention activities.

These activities which are carried out in application of the principle of optimization of protection recommended by the CIPR, necessitate the use of data collection procedures on the working environment.

As radon is the main danger of exposure in underground mines, one of the main roles of a radioprotection agent in a uranium mine is to apply these procedures in order to determine the locations and the intensity of radon sources, and check that the means of risk prevention implemented, especially those enabling the atmosphere to be purified from a radioactivity point of view, (primary and secondary ventilation) are used in the most advantageous way taking into account the state of the air, and that they remain suitable for the sources of exposure and the configurations of the work station.

To make a radiological diagnosis of a work place and determine preventive action, the inspection procedure is based on :

- a) real time checking of the quality of the atmosphere in the work place and respect of the "VGO" operational guide values which have been fixed as an objective.
- b) systematic checking of the prevention systems implemented.
- c) investigation of sources of pollution and identification of anomalies.

In addition to the check on the respect of the operational guide values and analysis of causes of excesses, test measurements enable us to define a series of coefficients characteristics of the purification performance of the sites and the sources.

## 5. CONSEQUENCES OF THE NEW RECOMMENDATIONS OF ICRP 60

Major efforts have been made over the last ten years in the mines operated by the COGEMA to respect the regulations in ICRP publications No. 26 and No. 47. This has been achieved since 1988 over all French underground operations.

In 1990 the ICRP made new recommendations resulting in a reduction in the limit of the total effective dose. Publications n° 60 and 61 introduce important modifications in the formula of the Total Annual Exposure Rat (see (1) page 5) : the gamma reference changes from 50 to 20 mSv and the long-lived alpha emitters limit from 1700 to 800 Bq.

The potential alpha energy annual limit of publication n° 47 is not modified at the present time but could be altered shortly.

The question arise for underground mines (uranium and non-uranium substances) of whether it is possible to further improve the radiological situation of workers.

We think that, for mines which already satisfy the regulations in ICRP publication 26 and 47, improvements are still possible. It should be noted that throughout the world, many maning operations do not yet satisfy the total effective exposure dose of 50 mSv.

However we should not look for them in stricter limitation of individual exposure levels, but rather within an overall optimization of the rational radioprotection management. This is a realistic method considering the progress which can be achieved in comprehension of the mechanisms of formation of collective exposure relative to various causes of exposure, and technical progress in mining methods.

If the emphasis is on the individual annual acceptability limit, some mining companies will be tempted to comply with limits by rotation of workers. Also, the spirit of ICRP 60 is not respected, ICRP wishing to ensure that collective doses are reduced. In addition, rotation of miners implies a higher conventional mining risk.

If, in certain stages of the fuel cycle, complying with the limit of 20 mSv per year does not occur, then the problem of complying with the individual limit regulations becomes a priority for many mining installations. Without wishing to reiterate the new limits recommended by the ICRP n° 60, we can state that in Uranium mines :

- the occurrence of radiation in the working varies with time and space, making its control difficult and necessitating inspection and follow-up procedures adapted to these uncertain variations ;
- an increase in the severity of individual limits connected with the radon risk would cause miners to have to manage professional levels of exposure comparable with those received naturally by the general public for the same radionuclides (short-lived decay products of radon 222 and 220 isotopes), and the same sources of exposure and for which the CIPR recommends nonintervention and the absence of management.

- in the case of existing mines, changing a method of working in order to adapt to new regulatory measures requires considerable time, inherent in the slow development in mining structures. Implementation periods of between five and ten years are currently met in underground mines ;
- epidemiological investigations exist which can permit, by showing the doses received, the checking of risk coefficients and also the defining of limits.

If we consider the characteristics specific to mining activity in the adoption of the individual limits recommended by ICRP n° 60, then it is necessary to introduce flexibility into underground uranium mines in :

- imposing a limitation like 20 TAER for the duration of the working life and a limit of 1 TAER per year (we must remember that miners clearly spend less than 50 years working underground) with :

$$TAER = \frac{\gamma}{50 \text{ mSv}} + \frac{PAE \text{ Rn222}}{20 \text{ mJ}} + \frac{PAE \text{ Rn220}}{60 \text{ mJ}} + \frac{P. \text{ ore}}{1700 \text{ Bq}\alpha}$$

- adapting the timelimits for the bringing up to standard to the timelimits needed to transform the methods of working the underground mines.

If we consider the worker's limit of exemption of 1 mSv, applied to the case of the alpha potential energy risk due to the radon and its daughters in keeping with the risk factor in the ICRP publication n° 47, the classification of "exposed worker" amounts to any person working in an atmosphere where the volumic activity averages 222 in radon is equal to around 100 Bq.m<sup>-3</sup> (hypothesis : equilibrium factor equal to 0.3). This is very weak and occurs in every underground area ; therefore this lowering of limits will affect almost all the mining industry and certain public work sites. So, it seems that the level of exemption should be kept at 0,1 TAER for underground work sites.

## 6. CONCLUSION

In addition, trying to manage a very severe statutory individual system would certainly lead to the system of risk management developed up to now by the CIPR being reconsidered. Knowing the considerable progress which the implementation of this radiological risk management system has enabled us to achieve in the French mines we as radioprotectionists would not be in favour of bringing it into question.

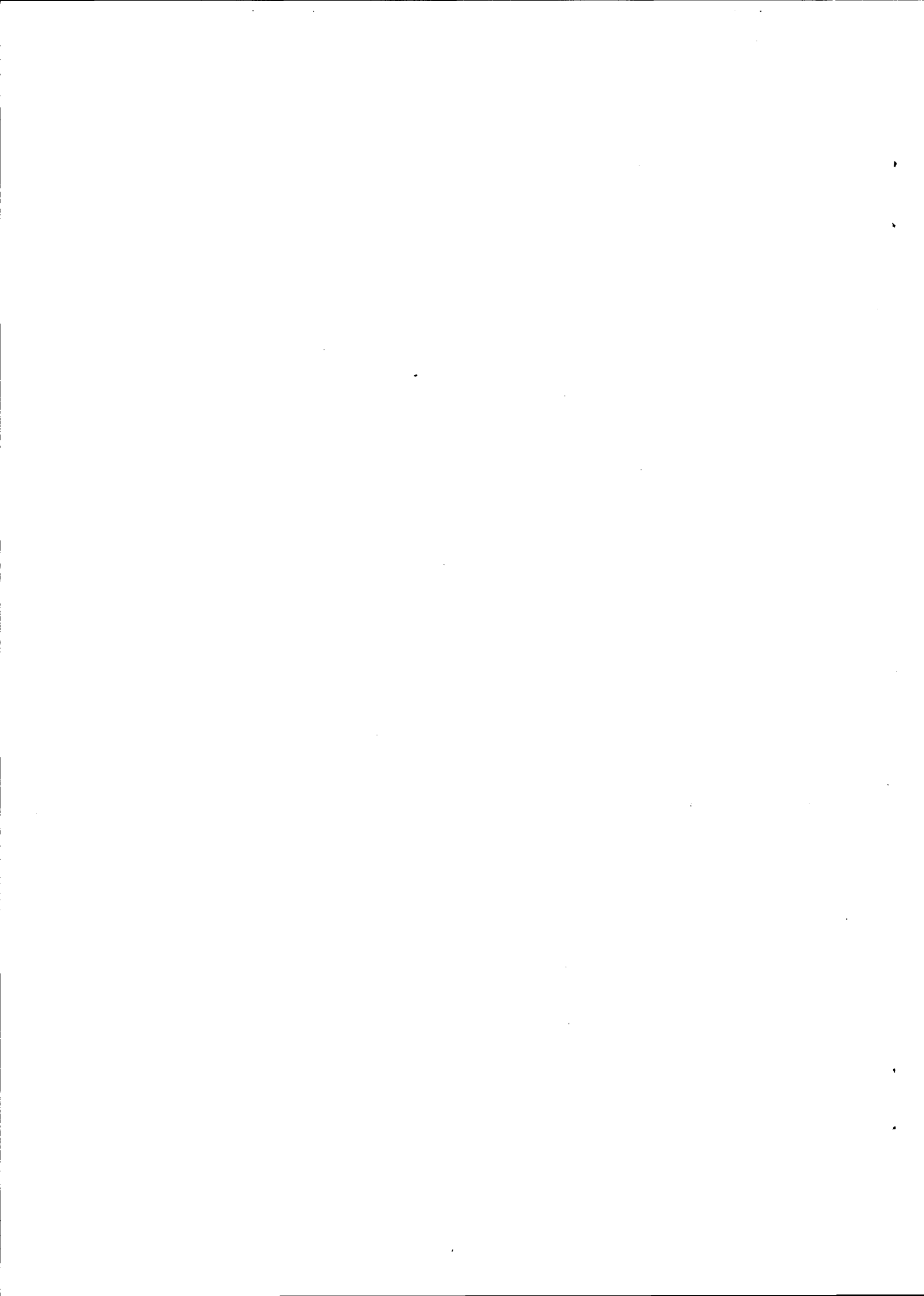



**BNS/OECD-NEA Symposium on the  
SAFETY OF THE NUCLEAR FUEL CYCLE  
BRUSSELS, 3-4 JUNE 1993**

**SAFETY ASPECTS IN THE DECOMMISSIONING OF  
URANIUM MILL FACILITIES**

**J. L. SANTIAGO  
ENRESA, SPAIN**

**ABSTRACT**

The milling of radioactive ores results in contaminated buildings and facilities which must be decommissioned, and large quantities of tailings which must be managed safely so that residual environmental and health risks do not exceed acceptable levels. In the south of Spain on the outskirts of the town of Andujar an inactive uranium mill facility is under decommissioning. Mill equipment, buildings and process facilities have been dismantled and demolished and the resulting metal wastes and debris have been placed in the pile. The tailing mass is being reshaped by flattening the sideslopes and a cover system will be placed over the pile. This paper describes the safety aspects and technical approaches which are being used for the remediation and closure of the Andujar mill site.

**RESUMÉ**

Le traitement de minerai d'uranium donne comme resultat des bâtiments and installations contaminées dont la gestion doit être faite de manière à ce que des conséquences fâcheuses pour les populations avoisinantes soient évitées. A Andujar (sur d'Espagne) existe une usine de traitement d'uranium inactive en cours de déclassement. Les produits provenant du démantèlement et démolition des équipements, bâtiments et installations du procès ont été introduits dans le digue que is en cours de réconfigurer par adoucissement des pentes et après sera placé sur le digue configuré a système de couverture. On décrit, dans ce texte, les aspects de sureté et les approches techniques que ont été utilisés pour la stabilisation du digue et le déclassement de la usine de traitement d'uranium á Andujar.

**1.- INTRODUCTION**

Empresa Nacional de Residuos Radiactivos, S.A. (ENRESA) is remediating an inactive uranium mill facility in the town of Andújar in the south of Spain. The Andújar plant became operational in 1959 and continued in operation until 1981. All solid waste generated during the operation of the plant are contained in a tailings pile, which covers an area of 9.4 hectares and has a total volume of about one million cubic meters. The pile was constructed in five cells by upstream construction to a height of 20 meters in the central and eastern parts and to a height of 10 meters in the western part. This paper summarizes the criteria used for the remediation and closure of the Andújar mill site and discusses the safety aspects associated with the decommissioning of the mill facilities.

## 2.- MILL FACILITY CHARACTERISTICS

The Andújar Uranium Milling Plant is in the province of Jaén (Andalucía) on the southern floodplain of the Guadalquivir river at 1.5 kilometers south from the urban center of Andújar. The location of the site is given in Figure 1. The site is trapezoidal in shape, covers an area of approximately 17.5 hectares and is contained within a peripheral wall, which is about 150 m from the course of the river.

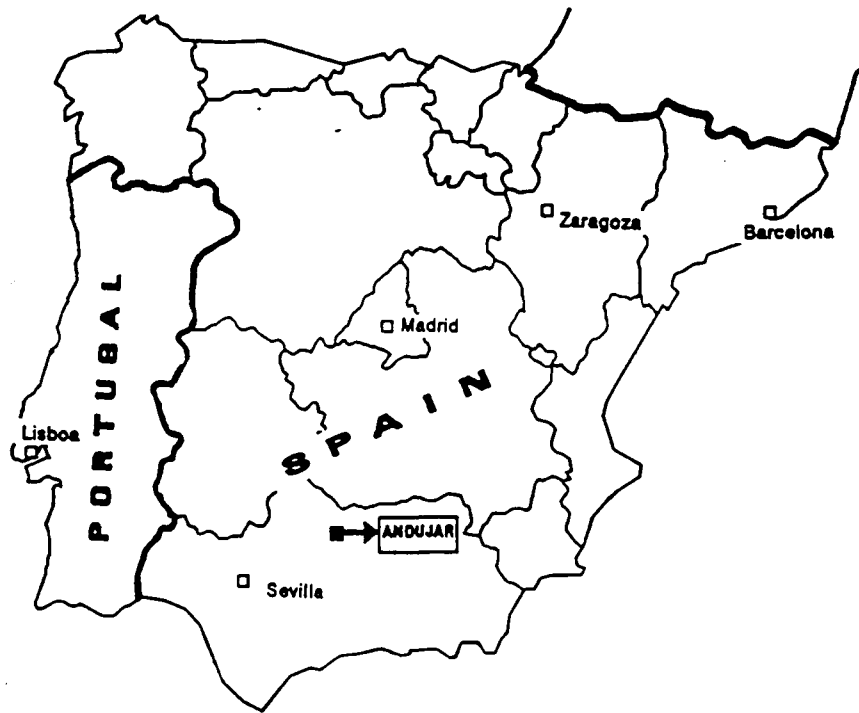

FIG. 1.- SITE LOCATION.

The plant was designed for processing low grade uranium ore (0.15% of  $U_3O_8$ ) and produced 80% concentrate of  $U_3O_8$  in the form of sodium and ammonium uranate at a rate of 60 to 80 tons per year. The plant became operational in 1959 and continued in operation until 1981. During this period 1.2 million tons of uranium ore were processed to produce 1350 tons of  $U_3O_8$  with a fineness of 80-85%. Recovery of the uranium involved sulphuric acid leaching followed by ion exchange or by tertiary amine/Kerosene extraction. Solid wastes were stored in the tailings piles and liquid wastes were treated before disposal to the Guadalquivir river.

The configuration of the Andújar mill site is shown in Figure 2 and includes the following areas: the tailings pile, the processing plant, the waste water treatment area, the auxiliary and administrative buildings and the housing area.

All solid waste generated during the plant's operation (1.2 million tons) are contained in the tailings pile, which sideslopes vary from 25 to 35 degrees and has a total activity of 4500 Ci.

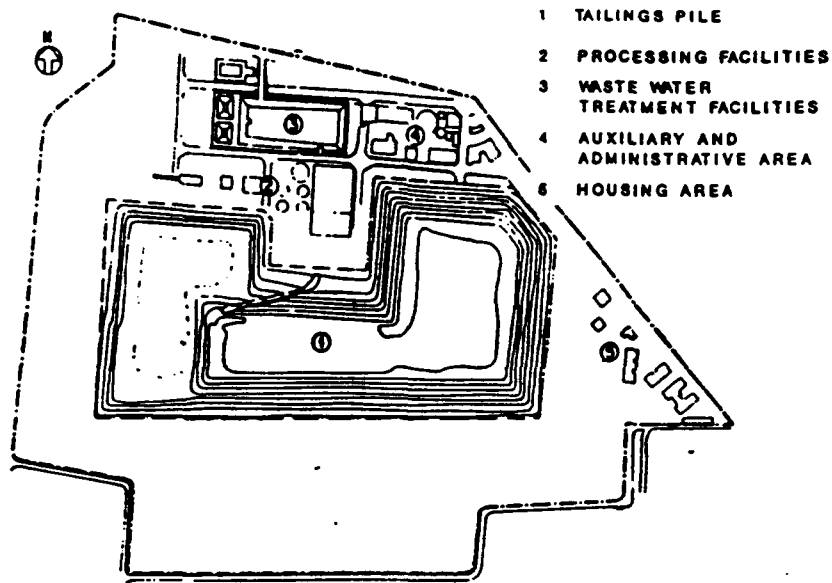

FIG. 2.- PRESENT CONFIGURATION ANDUJAR MILL SITE.

### 3.- SAFETY ASSESSMENT

Safety analyses were carried out to determine the short term and long term consequences (risks) to humans and the environment associated with the inactive milling site and the proposed decommissioning actions. Risks may arise from the tailings pile, the mill facilities and buildings and the contaminated soils around the site and may be generated by events such as:

- . Humans actions associated with intrusion into tailings or removal of contaminated materials.
- . Dispersion of contamination via air/water pathways.
- . Massive migration of tailings/contaminated materials as a result of structural failure or degradation of the pile and/or the buildings.

Scenario analyses were performed in which release and transport scenarios for radioactive pollutants were defined, followed by consequence analyses in which the radiological effects of the releases to the environment were evaluated.

The various scenarios considered for the Andujar mill site are shown in Figure 3. Important release mechanisms include: radon emanation, seepage and uncontrolled release of contaminated water, structural or seismic instability, wind and water erosion or dispersion, unauthorized removal of tailings and/or contaminated soils or materials.

Major risks associated with the decommissioning of mill facilities are listed below:

- . Direct gamma radiation produced by radioactive decay series of the U-238.
- . Tailings dispersion due to wind or water erosion and human or animal intrusion.
- . Contamination of surface waters due to water erosion and surface runoff which result in the dispersion of radioactive particles in the waters.
- . Groundwater contamination as a result of seepage of rainfall water through the tailings and the substratum and contaminant migration to underlying aquifers.

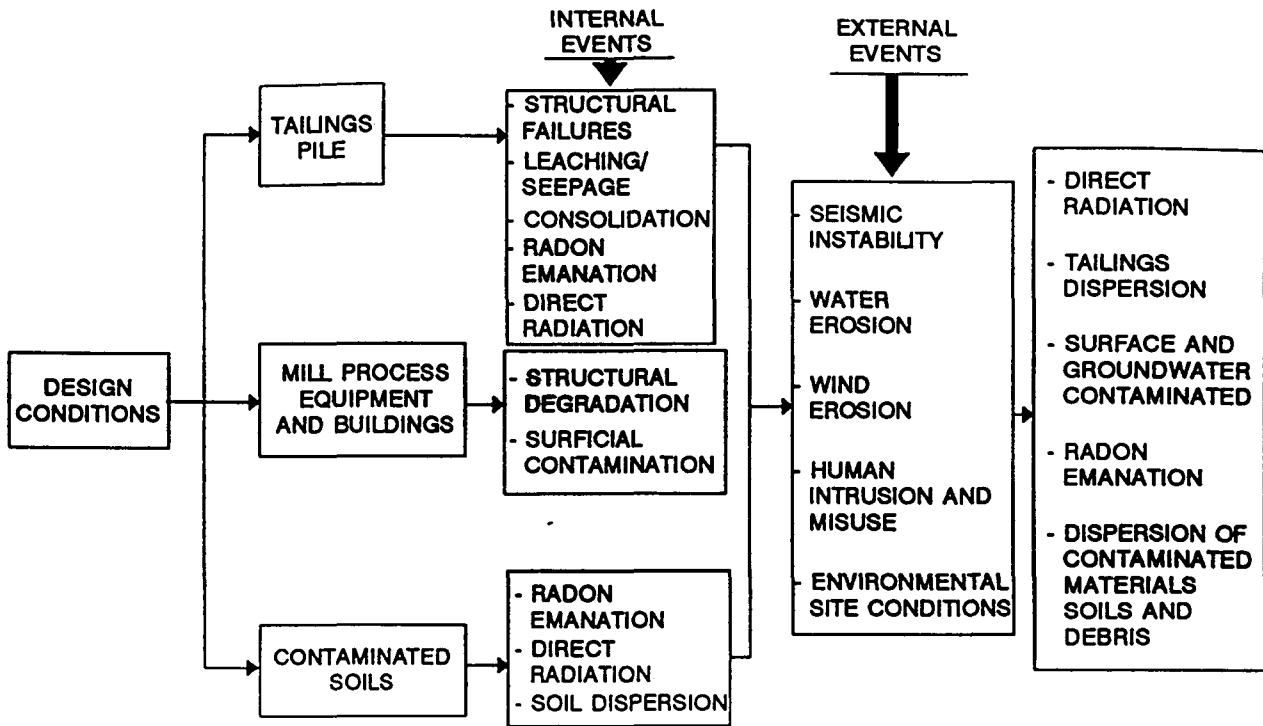

FIG 3.- POTENTIAL RISKS ASSOCIATED WITH INACTIVE MILL FACILITIES

- Radon emanation produced in the radioactive decay sequence of Ra-226.
- Dispersion of contaminated materials and/or soils by wind, water erosion, human or animal intrusion.

Major pathways by which the released pollutants can reach the environment and humans are as follows:

- Atmospheric pathways which lead to irradiation by inhalation of radon and its daughters, inhalation of airborne radioactive particles and external irradiation.
- Atmospheric and terrestrial pathways which can cause doses due to ingestion of contaminated foodstuff and external irradiation.
- Aquatic pathways which can result in the ingestion of contaminated water, foods produced using irrigation, fish and other aquatic biota, and through external irradiation.

To ensure that risks were adequately controlled, a set of fundamental safety and design criteria were established, as shown in Figure 4. Primary objectives were the following:

- Dispersion and stabilization control, to ensure confinement and long-term stability of tailings and contaminated materials.
- Erosion control to prevent surface water contamination and ensure long-term integrity of the closed-out facility.
- Radon control to reduce radon emissions.
- Groundwater protection to prevent groundwater contamination by rainfall waters infiltrating into the tailings.

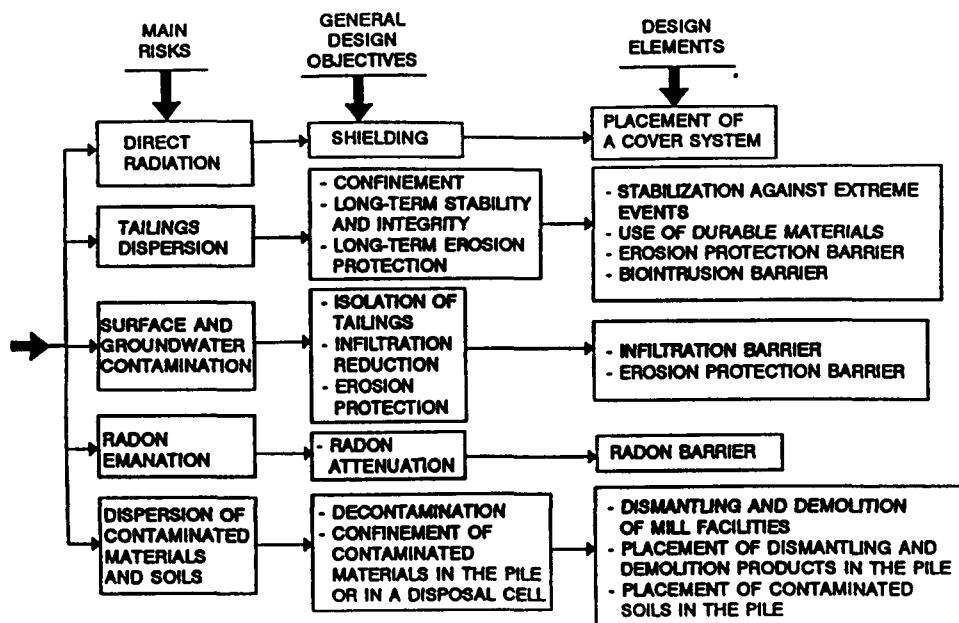

FIG 4.- OBJECTIVES AND DESIGN ELEMENTS

To achieve these objectives, the following design elements were incorporated into the decommissioning plan (Fig. 4).

- . Stabilization against extreme events by slope flattening and pile reshaping.
- . Dismantling and demolition of mill facilities and buildings, and placement of metal wastes/debris in the pile.
- . Placement of a cover system including a radon barrier, an infiltration barrier, a biointrusion barrier and an erosion protection barrier.

#### 4.- REGULATORY AND DESIGN OBJECTIVES

The regulations and standards that govern the remediation activities at Andujar have been established by the Spanish Nuclear Safety Council (CSN), taking into account the recommendations of international organizations (ICRP, IAEA and OECD/NEA), the standards promulgated by the U.S. Environmental Protection Agency for the remediation of uranium mill tailings, and the Spanish regulations, specifically those related to groundwater protection and the long-term disposal of radioactive wastes. These regulations may be summarized as follows:

- **Dispersion Control:** Prevent inadvertent human intrusion and dispersion of contaminated materials by wind and water erosion.
- **Long-term Radiation Protection:** Achieve an effective equivalent dose to the individual in the critical group below 0.1 mSv/year.
- **Design Life:** Remain stable for 1000 years to the extent reasonably achievable and in any case for at least 200 years.
- **Soil Cleanup:** Reduce the residual concentration of radium-226 in land, averaged over an area of 100 m<sup>2</sup>, so that the background level is not exceeded by more than 5pCi/g (averaged over the first 15 cm soil) and is less than 15 pCi/g (averaged over 15 cm thick layers of soil more than 15 cm below the surface).

- \* **Radon Control:** Reduce radon flux over the surface of the final pile to an average release rate of less than 20 pCi/m<sup>2</sup> s.
- \* **Groundwater Quality Protection:** Control groundwater contamination so that background water quality or maximum concentration levels (in accordance with Spanish regulations and CSN guidelines for radioactive constituents) are achieved in the long-term. These maximum levels are: combined radium-226 and radium-228 0,18 Bq/l (4,86 pCi/l), combined uranium-234 and uranium-238 1,2 Bq/l (32,4 pCi/l) and gross alpha activity, excluding radon and uranium, 0,5 Bq/l (13,5 pCi/l).
- \* **Long-term Maintenance:** Minimize the need for long-term maintenance.
- \* **Construction Works:** Minimize hazards to the workers and the environment.
- \* **Regulations:** Comply with other applicable and relevant spanish regulations governing air and water quality in non radiological aspects.

With regard to groundwater quality protection, it is also required that for short-term conditions the cover system be designed to limit infiltration to ensure that, at the end of the compliance period (minimum 10 years), the combined uranium-234 and uranium-238 concentration in groundwater complies with the two following conditions:

- \* Be less than 6.15 Bq/l (166pCi/l) at the point of compliance, at the downgradient boundary of the disposal site.
- \* Be less than 3,5 Bq/l (94,5 pCi/l) at the wells in the vicinity of the site.

In addition to the above design standards, a performance standard has been established for Andujar: groundwater quality must be monitored during the compliance period (minimum 10 years) to confirm adequate performance of the cover and compliance with the maximum concentration limits established for short-term conditions.

## **5.- REMEDIAL ACTION PLAN**

The remedial action plan proposed for Andujar mill site, involved stabilizing and consolidating the uranium mill tailings and contaminated materials in place. The actual tailings pile were reshaped by flattening the sideslopes to improve stability. Tailings from sideslope flattening were relocated around the existing pile and on the top of the lower pile. Mill equipment, buildings and process facilities were dismantled and demolished and placed in the tailings pile. Off-pile contaminated soils were excavated and placed on top of tailings pile in order to reduce the radon flux.

The final pile configuration, as shown in Figure 5, was designed to minimize the movement of tailings and the size of the restricted disposal area. The pile was constructed with four percent topslopes and 20 percent sideslopes which provide static and dynamic slope stability without requiring excessively large rock to resist erosion. Protection against upland watershed runoff is provided by channelling runoff around and away from the pile via drainage diversions wales along the perimeter of the pile. Protection against floods associated with the Guadalquivir river is provided by a rock apron around the perimeter of the pile and riprap layers on the sideslopes.

Decommissioning of mill facilities and buildings involved the dismantling of the facilities, the demolition of the buildings, the reduction of metal wastes and demolition debris to manageable pieces, the cementation of the metal wastes and the disposal of dismantling and demolition wastes in the tailings pile. Special containers were used to facilitate handling, transportation and cementation of the metal wastes. Cementation proved to be a cost-effective operation and provided a more stable structure to the wastes than the conventional alternative of mixing and compacting with the tailings.

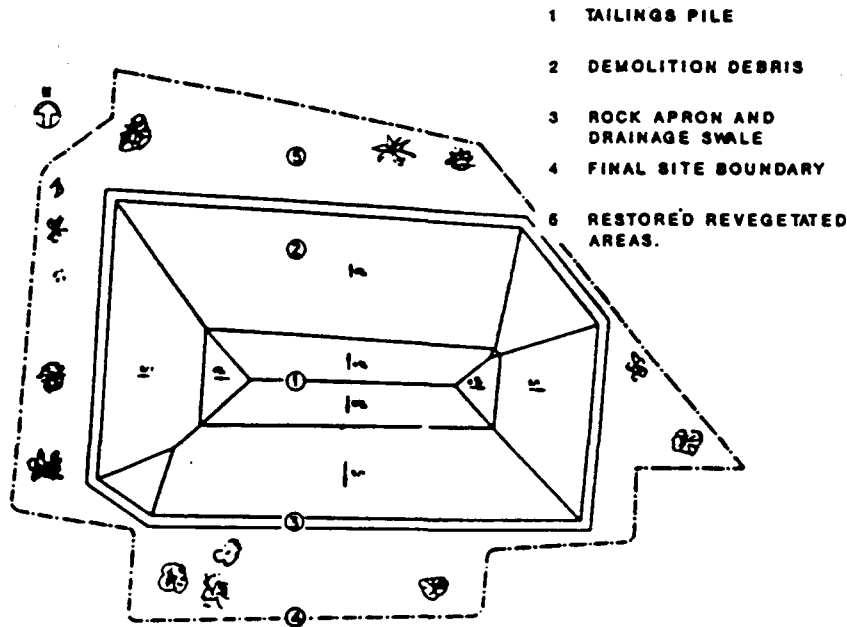
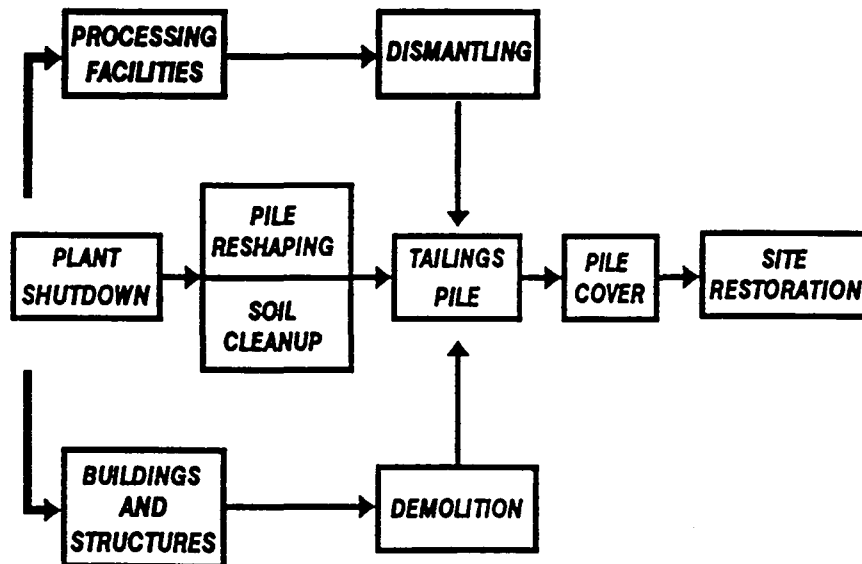

FIG. 5.- ANDUJAR SITE AFTER REMEDIATION.

The pile will be covered with a multilayer system to meet the three simultaneous demands of erosion control, infiltration and radon control. In order to comply with the standards, the following design elements are incorporated into the cover system:

- Stabilization control for up to 1000 years: Only natural materials are used and the cover is designed to resist extreme events such as probable maximum precipitation, probable maximum flood, maximum credible earthquake.
  - Dispersion and intrusion control: erosion protection layers and biointrusion barriers within the cover.
  - Soil clean-up: Remove contaminated soils and incorporate them within the tailings underneath the cover system. This reduces the thickness of the radon barrier.
  - Radon control: a radon barrier of natural soils.
  - Protection of groundwater quality: a multiple redundant cover system to limit infiltration. This system includes soil/vegetation layers, drain layers and a low permeability infiltration barrier.
  - Long-term maintenance: a rooting medium for the establishment of climax vegetation.
- Major activities involved in the remedial action (Fig. 6) are listed below:
- Preparation of the site including construction of a new waste-water retention basin to protect against release of contaminants, a decontamination pad to wash down equipment, field offices, and shower/change facilities.
  - Construction of drainage control measures to direct generated waste-water and contaminated storm-water runoff to the retention basin during construction activities.
  - Dismantling of processing facilities and burial of contaminated materials in the tailings pile.
  - Demolition of mill buildings and structures and burial of debris in the tailings pile.

- Reshaping the existing tailings pile and excavating, transporting and placing off-pile contaminated materials on the tailings pile.
- Construction of the final cover system over the tailings to inhibit water infiltration, radon emanation, and wind and water erosion.
- Restoration of the excavated areas, to ensure proper drainage.
- Revegetation of the pile and excavated areas on and adjacent to the processing site.
- Construction of the final fencing.



**FIG. 6.- REMEDIAL ACTION PLAN.**

Fig. 7 shows the cover components for top and sideslopes of the final disposal cell. The topslope consists of, from top down.

- 50 mm erosion barrier of mixed gravel and soil
- 500 mm vegetation growth and desiccation protection zone of random soil.
- 250 mm filter of clean sand.
- 300 mm blaintrusion barrier of coarse rock.
- 250 mm drain of clean sand.
- 600 mm radon and infiltration barrier of silty clay.

The most significant benefits of this cover are its ability to deal effectively with vegetation and to reduce infiltration to the cell because of effective evapotranspiration.

From the top down, the sideslope cover consists of:

- 30 mm of soil to migrate into the rock and help support vegetation.



- . 300 mm erosion barrier of soil/rock matrix.
- . 500 mm vegetation growth and desiccation protection zone of random soil.
- . 250 mm filter of clean sand.
- . 300 mm biointrusion barrier of large rocks.
- . 250 mm drain of clean sand.
- . 600 mm radon and infiltration barrier of silty clay.

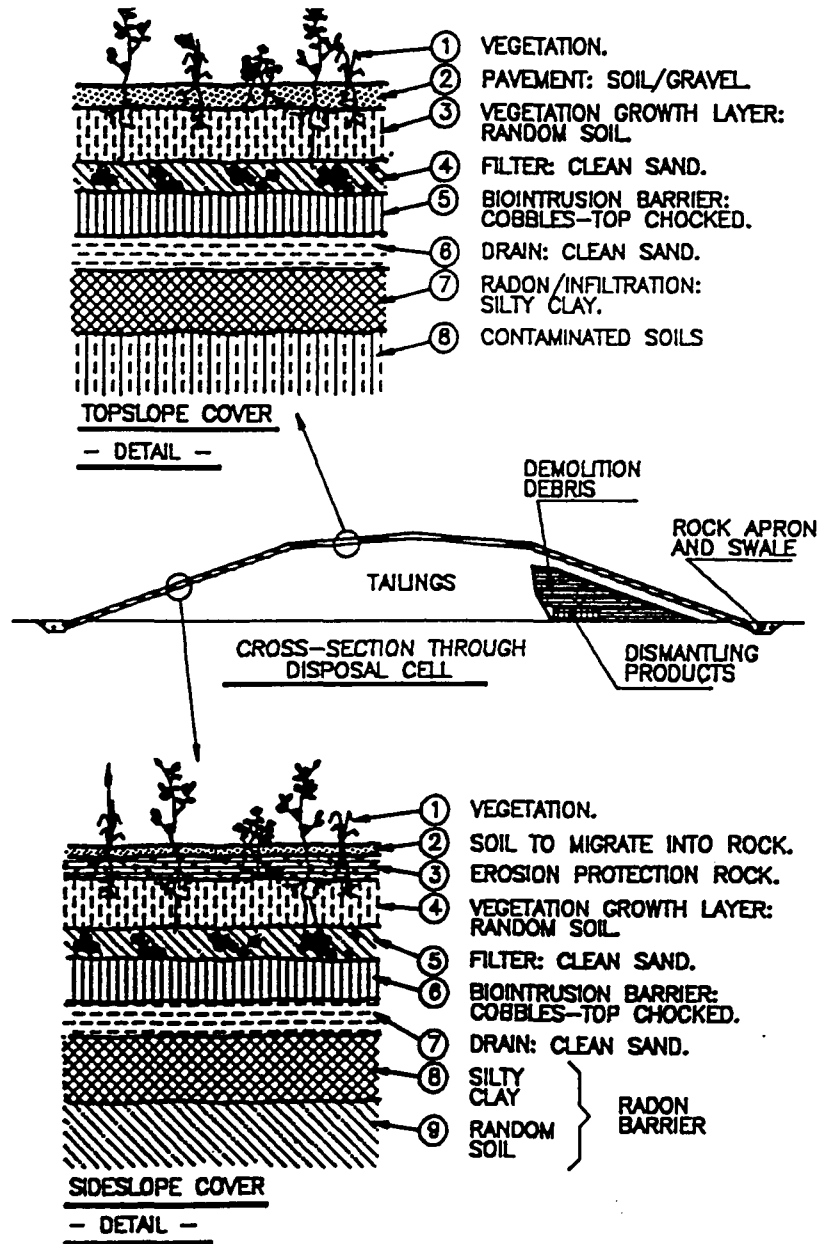

FIG. 7.- COVER DESIGN FOR ANDUJAR TAILINGS PILE.

Advantages of this cover include protection of the radon infiltration barrier from desiccation and the existence of a controlled zone-the random soil- for vegetation that might establish through the riprap and help reduce the visual impact of the remediated pile.

## **6.- CONCLUSIONS**

This paper has reviewed the design criteria and safety approaches followed for the remediation of the Andujar mill site. The decommissioning consists of stabilizing and consolidating the uranium mill tailings and contaminated materials in place. A multilayer cover will be placed over the pile to control water infiltration, erosion and radon exhalation.

BNS/OECD - NEA Symposium on the  
SAFETY OF THE NUCLEAR FUEL CYCLE  
BRUSSELS, 3 - 4 JUNI 1993

SAFETY AT THE CENTRIFUGE ENRICHMENT PLANTS  
OF URENCO NEDERLAND AT ALMELO

B.G. Dekker  
Urenco Nederland

**Abstract**

The safety relevant aspects of the centrifuge enrichment plants of Urenco Nederland are reviewed in this paper. The potential hazards of uranium-hexafluoride are discussed as well as the measures taken to assure safety of personnel and environment. Recent studies have demonstrated that the total environmental impact of the plants at Almelo is very low.

**Resumé**

Ce document fasse en revue les aspects de sureté ayant trait aux usines d'enrichissement de la firme Urenco Nederland. Les dangers potentiels occasionnés par l'emploi d' $UF_6$  sont discutés en parallèle avec les mesures prises pour assurer la sécurité du personnel et de l'environnement. Des études récentes ont démontré que l'impact sur l'environnement des usines d'Almelo est tres faible.

**Summary**

The Urenco-organisation operates uranium enrichment plants with ultra-centrifuges. The uranium is processed in the form of uraniumhexafluoride ( $UF_6$ ) and can be of natural origin as well as originate from reprocessing. A centrifuge enrichment plant operates at sub-atmospheric pressures, so that in case of leakages primarily ingress of ambient air takes place rather than release of  $UF_6$ . Super-atmospheric pressures can be present only in the feed systems and special precautions are taken there to protect personnel and environment. The radioactive gaseous and liquid releases are very low during normal operations and also the usage of other materials in auxiliary systems is small. The environmental impact of a centrifuge enrichment plant is very low. The radiation dose received by personnel is also low. Incident history shows only small releases of  $UF_6$ , which were all kept inside. Urenco plants operate safe and reliable.

## 1. The Urenco-organisation

The Urenco-organisation operates enrichment plants in the United Kingdom (Capenhurst), Germany (Gronau) and the Netherlands (Almelo). The information presented in this paper is based on the operational experiences at Almelo.

The Urenco-organisation has been founded as a result of the Treaty of Almelo (1970) and grew through the erection and operation of pilot plants and demonstration plants to the present industrial set-up with an operational capacity of approx. 2.800 tSW/yr. (900 tSW/yr at Capenhurst, 500 tSW/yr at Gronau and 1.400 tSW/yr at Almelo). Further extension of the capacity is in progress.

All commercial affairs are handled by Urenco Ltd, Marlow UK.

## 2. The enrichment process

The Urenco-organisation applies ultracentrifuges in her enrichment plants. Several centrifuges are connected and grouped together in, what are called, cascades. Several cascades form an operational unit. Every enrichment plant houses a number of operational units.

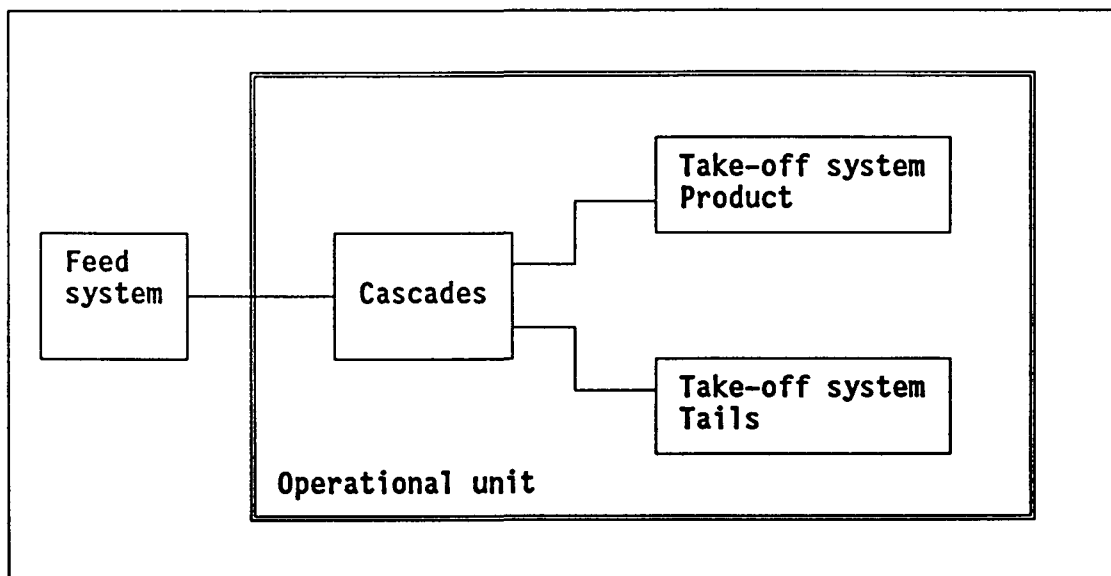

Figure 1: Schematic enrichment plant

A schematic of an enrichment plant is shown in figure 1. Feedsystems are in general serving more than one operational unit unless it concerns special feed qualities (e.g. reprocessed feed). Take-off systems are generally allocated to one operational unit but also may serve more than one.

The typical safety related aspects of the different sections of an enrichment plant as shown in figure 1 are discussed in later paragraphs.

Besides the UF<sub>6</sub>-related systems an enrichment plant needs several auxiliary systems such as steam and hot water systems, cooling water systems, electrical systems, etc. Furthermore there are a number of general services required to support and/or finish the enrichment process. In this respect blending and homogenising operations and decontamination are to be mentioned. The safety related aspects of these are also discussed in later paragraphs.

### 3. Uraniumhexafluoride

The ultracentrifuges of Urenco are gascentrifuges so it is necessary to have the uranium available in gaseous form. Uraniumhexafluoride (UF<sub>6</sub>) is the chemical composition of uranium with properties that allow for rather easy generation and recovery of the process gas required. Vapour pressure key data of UF<sub>6</sub> are shown in Table 1.

Table 1: Vapour pressure data of UF<sub>6</sub>

	Temperature °C	Vapour pressure Pa
solid	- 70	1,1
solid	20	10,6 x 10 <sup>3</sup>
sublimation point	56	100 x 10 <sup>3</sup>
triple point	64	151,6 x 10 <sup>3</sup>
liquid	120	669,8 x 10 <sup>3</sup>

The quality of UF<sub>6</sub> is specified in ASTM C787-90 for feed material and ASTM C996-90 for product material. The feed material knows two qualities, the so-called "commercial natural uranium" and "reprocessed uranium".

In addition to the uranium isotopes and other items mentioned in the specification for commercial natural uranium, the reprocessed uranium specification allows for a higher U-234 content and the availability of U-232, U-236 and other fission products and transuranics. Especially the U-234 is responsible for a higher specific activity ( $\alpha$ ) and the U-232 (namely the daughters) can cause a higher source for external radiation.

Apart from the radiological properties of UF<sub>6</sub>, the chemical stability is important from a safety point of view. When UF<sub>6</sub> comes in contact with water, it readily decomposes to uranylfluoride (UO<sub>2</sub>F<sub>2</sub>) and hydrogenfluoride (HF). The HF is very aggressive when dissolved in water, which may happen when dry HF comes in contact with wet human tissue such as skin, eyes and lungs. The reactivity of UF<sub>6</sub> requires clean, dry and air tight enclosures for processing, storage and transport.

A centrifuge enrichment plant with a capacity of 1.500 tSW/yr may hold some 550 tons of  $UF_6$ -material of which only about 1‰ is on the way in the cascade systems. The majority of the material is present in  $UF_6$ -cylinders in the feed systems and the take-off systems.

Radiation exposure resulting from  $UF_6$  operations is more a result of emptied containments than of containments filled with  $UF_6$ . The radiation is caused by  $\beta$ - and  $\gamma$ -emitting uranium daughter decay. In case of containments full of  $UF_6$  this radiation is shielded by the uranium present. When cylinders and other containments are emptied by gassing-off, the uraniumhexafluoride disappears but the daughter products of uranium remain as non-volatiles and the radiation emitted is then unshielded. Every gassing-off cycle contributes to a build-up of daughter products, till equilibrium is reached.

#### 4. Feed systems

The feed systems have to generate  $UF_6$ -gas at a pressure of about  $5 \times 10^3$  Pa to serve the cascade systems.  $UF_6$ -cylinders are placed in heating tanks which are constructed as autoclaves. The cylinders are heated by circulating air that in turn is heated by steam tubes; in this way there are two barriers between the steam and the  $UF_6$ .

The  $UF_6$ -content of the cylinder is liquified and further heated to about 80 °C, corresponding with a vapour pressure of some  $200 \times 10^3$  Pa. This pressure has to be reduced to the forementioned  $5 \times 10^3$  Pa. In the feed systems super-atmospheric  $UF_6$ -pressure can be present, which means a release of  $UF_6$  in case of system leakages.

Leakages of the  $UF_6$ -cylinder and piping inside the heating tank are contained within the autoclave construction. Building sections where  $UF_6$ -piping with super-atmospheric pressure is present are equipped with air monitors and air cleaning equipment. The latest development in this respect is the location of the pressure reducers inside the autoclaves. By doing so, all system sections with super-atmospheric are than in "double containment".

#### 5. Cascade systems

The cascade systems are combinations of main headers, cascade piping and ultracentrifuges, together with the drive systems, the instrumentation, the cooling water systems and the vacuum systems.

The  $UF_6$ -gas pressure of  $5 \times 10^3$  Pa is further reduced when entering the cascades.

The cascades form a very large low vacuum system with a very low  $UF_6$  hold up. The low hold-up can be seen as a built-in safety feature, but is also of great advantage when changing feed qualities (short equilibrium times and no cross-contamination). The low hold-up implies that the  $UF_6$ -release potential of the cascade systems is negligible.

## 6. Take-off systems

The enriched and depleted gas streams have to be taken from the cascades and brought to the  $UF_6$  cylinders located in the filling stations. This can be done by applying desublimers which collect gaseous  $UF_6$  by desublimation at  $-70\text{ }^\circ\text{C}$ . Emptying of desublimers has been done in the past by liquifaction of the  $UF_6$ , followed by drainage to the  $UF_6$  cylinders at a lower level.

Because liquid  $UF_6$  implies super-atmospheric pressure, nowadays emptying of desublimers is done by gassing-off at sub-atmospheric pressures thus reducing the potential risk of  $UF_6$ -releases.

The disadvantage of gassing-off of desublimers however is the build-up of daughter products, which is less a problem when processing natural uranium.

Most modern take-off systems use compressor systems to bring the  $UF_6$  from the cascades to the cylinder filling stations. Thus intermediate solidification and gassing-off is avoided, which is especially important when processing recycled uranium.

## 7. Exhaust and ventilation systems

The  $UF_6$ -systems described in the previous paragraphs are maintained closed and leak tight when in operation. It is however unavoidable to open up a system from time to time for maintenance purposes and to connect and disconnect cylinders. When this has to take place the relevant system sections are evacuated and purged with nitrogen. When finally the system is opened, the exhaust system (elephant noses) is used to collect any fumes or gasses that might come free. The exhaust system also collects the air from vacuum pump outlets. All air collected by the exhaust system is cleaned before release to the environment.

Building sections where super-atmospheric  $UF_6$ -systems are present, have ventilation systems with a possibility for cleaning of the ventilation air in case of  $UF_6$  releases. The cleaning systems consist out of HEPA filters for  $UO_2F_2$  and active carbon filters for HF.

## 8. Blending and homogenising

The enrichment of  $UF_6$  as produced in the enrichment plants can be changed by blending different lots. The blending station has autoclaves and filling stations for this purpose. In the autoclaves the  $UF_6$  is gassed off and directly brought to the cylinders in the filling stations where it desublimates. In the autoclaves the pressure of the  $UF_6$  can be super-atmospheric, but outside the autoclaves all systems work at pressures below atmospheric pressure.

Before delivery, enriched  $UF_6$  has to be homogenised and liquid samples have to be taken. The cylinders to be delivered are placed in special autoclaves, heated, liquified and sampled. All these operations take place inside the closed autoclaves; there are no  $UF_6$ -connections to the outside of these autoclaves.

## 9 Storage and transportation of UF<sub>6</sub>

Storage and transportation of UF<sub>6</sub> is done in cylinders that conform to ANSI N 14.1. Transports to and from the plant are subject to (inter-)national regulations. The packaging requirements laid down in these regulations provide adequate safety, even under accident conditions. From the transport accidents that have been recorded, none resulted in a release of UF<sub>6</sub>.

One return shipment of empty cylinders from the Netherlands to Canada resulted in damaged and contaminated freight containers. The reason was improper stowage of the cylinders so that they could move around inside the freight container when the ship was facing heavy seas. Cylinder valves were damaged and contamination could be washed out of the cylinders by sea water:

UF<sub>6</sub> vapour pressure at ambient temperature is below atmospheric. In case of a leakage, air will ingress rather than UF<sub>6</sub> will leak out. Any moisture that might enter the cylinder will react with the UF<sub>6</sub> to (HF and) UO<sub>2</sub>F<sub>2</sub> that forms a layer on the UF<sub>6</sub> and delays further reaction.

Cylinder yards are inspected periodically and cylinders that are in frequent use are reinspected and pressure tested every five years.

## 10. Decontamination

System components (vacuum pumps, valves, etc.) that are removed from the process for reason of maintenance have to be decontaminated before they can go to the work shops. Cylinders have to be cleaned for reasons of reinspection or when heel contents exceed specified limits. Decontamination also takes place when systems come to the end of their use.

Decontamination activities make use of aqueous solutions with detergents, acids or alkalis. The resulting contaminated waste water is treated in an evaporator system. The distillate is disposed of via the public sewer system after a check against the licence values. The concentrate is sent to the solid waste depository of the Netherlands.

All decontamination activities take place in exhaust cabinets, glove boxes or in enclosed systems that are connected to the exhaust system. All exhausted air is cleaned before release to the environment.

## 11. Environmental impact report

In support of a licence application to extend the capacity of the site Almelo to 2.500 tSW/yr, an environmental impact report has been prepared recently. The outcome of the studies and investigations which have been carried out for the preparation of the report show negligible effects on the environment. Emissions of HF and radio-activity are low and effects can only be calculated and not measured.



Increased radiation levels at the fences of the site are measured only where the cylinder storage yard is close to the fence and when cylinders are present.

There are also negligible effects of the systems that are in operation to support the enrichment process. These systems are: electric power supply, steam and hot water generation, cooling water systems, ventilation systems, compressed air systems, etc. Process materials necessary for these systems are small in quantity or handled and treated in such a way that no releases and spillages take place. In this respect the use of CFC's is to be mentioned. CFC's are used in the existing enrichment plants for refrigeration and heat transfer. New plant designs will not make use of CFC's anymore. Programs are underway to limit the use of CFC's in existing plants and/or replace them with drop-ins when available.

The environmental impact report also describes accident conditions. Measurable off-site effects will only happen in case of an airplane crash on a storage yard or on autoclaves of feed systems. In such a case 20 to 35 tons of  $UF_6$  may be set free. The  $UF_6$  will react with moisture in the ambient air and the reaction products will rise and disperse in the direction of the wind. No fatal effects are expected, but crops may show contamination levels that would be a reason for rejection.

#### 12. Radiation exposure of personnel

The radiation dose received by plant personnel is very low and is below 1 mSv/yr. Only personnel that handles cylinders may receive a higher dose, up to 3 mSv/yr at present. The largest contribution to this higher dose is caused by the emptied cylinders. The introduction of recycled uranium did not show significant changes with regard to the radiation dose. The higher radiation levels of (emptied) cylinders with reprocessed feed have been compensated for by technical measures (shielding) and modified use of cylinders (empty feed cylinder is used for tails).

#### 13. Incident history

Incidents with small releases of  $UF_6$  occurred in the pilot plants and the demonstration plant. All releases were small (in the order of max. 100 gr  $UF_6$ ), contained within the buildings and handled by the air cleaning systems. All incidents were related to  $UF_6$ -systems operating at super-atmospheric pressures.

In the large industrial plant about 2 kg of  $UF_6$  have been released due to a leaking valve. This valve was located in an autoclave and all contamination was contained inside. The autoclave was evacuated by the exhaust system and decontaminated. This incident proved the function of the autoclaves as secondary containment.

#### 14. Conclusion

The release risk potential of the centrifuge enrichment process is very low (sub-atmospheric systems). Adequate measures have been taken where this risk is potentially higher (super-atmospheric systems). Radiation exposure is low and environmental impact is almost negligible, also when non-natural uranium is processed. Operating experience and incident history confirm safe and reliable operations of Urenco.

BNS/OECD - NEA Symposium on the

Safety on the Nuclear Fuel Cycle

Brussels, 3-4 June 1993

**SAFETY RECORDS OF URANIUM ENRICHMENT IN THE EURODIF**

**FRENCH DIFFUSION PLANT**

Th. Charles  
Institut de Protection et de Sûreté Nucléaire  
Département d'Evaluation de Sûreté  
IPSN/CEA/Marcoule (France)

**ABSTRACT**

Uranium hexafluoride ( $UF_6$ ) is the feedstock used in industrial processes for the enrichment of uranium with isotope 235, whether for civil or military purposes. In France, this product is used in facilities concentrated at the Tricastin site. These essentially consist of the Comurhex  $UF_6$  conversion plant and the Eurodif gaseous diffusion enrichment plant. A reviewing of the experience feedback from the latter, which has a capacity of 10.8 million SWU per year, and the lessons drawn from the principal incidents and accidents which have affected the French facilities using  $UF_6$  are presented.

**RESUME**

L'hexafluorure d'uranium ( $UF_6$ ) est le produit de base de l'industrie de l'enrichissement de l'uranium en isotope 235, que ce soit à des fins civiles ou militaires. En France, le site du Tricastin regroupe les usines mettant en oeuvre ce produit, et notamment les usines Comurhex de conversion en  $UF_6$  et Eurodif-Production d'enrichissement par diffusion gazeuse. Une synthèse de l'expérience d'exploitation de cette dernière usine, d'une capacité annuelle de 10,8 MUTS, est présentée ainsi que les enseignements tirés des principaux incidents et accidents ayant affecté les installations françaises mettant en oeuvre de l' $UF_6$ .

Uranium hexafluoride (UF<sub>6</sub>), the feedstock used in the enrichment of uranium with isotope 235, is a product which has been in regular use in the nuclear industry for some fifty years, both for military applications and for nuclear power generation in nuclear reactors.

In France, the Eurodif gaseous diffusion plant at the Tricastin/Pierrelatte site has been producing enriched uranium since 1978 to fill the requirements of nuclear fuel producers throughout the world, while Comurhex has been producing uranium hexafluoride at the same site for more than fifteen years. This site, which also includes four 900 MW nuclear reactors, a FBFC pressurized water reactor fuel fabrication plant, a Cogema gaseous diffusion plant and a number of CEA research facilities, constitutes one of the foremost nuclear sites anywhere in the world. In view of the quantities of UF<sub>6</sub> present and utilized at the site, a vast amount of operating experience has been acquired and many safety lessons have been drawn. Furthermore, feedback of experience relating to accidents which have occurred in other countries has also made it possible, by examining the lessons which can be drawn from it, to ensure that the facilities are able to cope with such accidents, or otherwise to increase their safety levels.

#### 1. Eurodif plant operating experience

The uranium 235 enrichment plant operated by Eurodif-Production uses the gaseous diffusion process. This plant has a capacity of 10.8 million separation work units (SWUs) per year and the maximum enrichment of uranium authorized is 5%.

The construction of the plant was authorized by decree on 8th September 1977. Its commissioning lasted from December 1978 to August 1982, when it became fully operational.

##### Brief description of the plant

The plant consists of the following sub-systems :

- the enrichment cascade, in which the process takes place, consists of 1400 diffusion stages of three different sizes, grouped in units of 20 (referred to as the "diffusion group") and six sub-cascades separated by 5 junctions. The latter make it possible to disconnect and return the sub-cascades to service, and above all, to match the flow and pressure of the process fluid between the sub-cascades. This system is contained in four buildings, connected by a communication gallery approximately 1 km in length,
- the associated special units which enable operation of the cascade, essentially consist of those provided for the UF<sub>6</sub> supply, "rich" production fluid extraction, "waste" fluid extraction, group filling and extraction, "purge" process fluid purification, treatment of fluorinated residues and washing of the vents. These units are grouped in a building designated "Annex U",
- the UF<sub>6</sub> management unit handles reception, checking and dispatching of the product (REC), with associated UF<sub>6</sub> containers interim storage areas,
- the auxiliary units, of which the essential role is to supply the different utilities needed for the process, such as electrical power and cooling water,
- the centralized control system of the plant, consisting of two independent parts, one for the process units with two control rooms (one being used when the other is unavailable) and the other for electrical power distribution.

Process control is fully centralized, but the initiation of the automatic sequences affecting safety can also be made locally.

Electrical power is supplied by the four 900 MW nuclear units on the site. Power is distributed via a 400/225 kV local sub-station, itself connected to the EDF national grid and an incoming line from a hydroelectric power station, which provides the last-resort back-up in the event of loss of the other power supplies.

The quantity of UF<sub>6</sub> present in the facility in solid form alone is greater than 100,000 tonnes, as compared to the few hundreds of tonnes present in solid, gaseous and liquid forms in Annex U and the some 2000 tonnes present in gaseous form in the enrichment cascade.

These large amounts of uranium hexafluoride and the complexity of the installation, which has many kilometres of pipework and thousands of valves and chambers, give an idea of the potential hazards of such a plant.

#### Experience feedback

In the last fifteen years, some 484 incidents were recorded. For the sake of simplicity, these have been divided into six main categories :

- leaks of UF<sub>6</sub>,
- leaks of cooling water in the process system at the junction or diffusion stage heat exchangers. Concerning this point, it must be borne in mind that a stage consists of a stack including a compressor, a UF<sub>6</sub>/water heat exchanger and a diffuser in which isotopic separation takes place,
- chemical reactions involving fire or explosion, essentially resulting from the reactivity of the fluoriding agent used in the systems,
- electrical equipment operating faults,
- faults affecting the process control system,
- miscellaneous faults.

The bar chart of the number of incidents per year shows an increase up to 1980, which corresponds to the startup phase of the facility, and a regular decrease until 1984, when it stabilized at the average value of 30 per year, then of 15 per year from 1986 (9 in 1992). Globally, the UF<sub>6</sub> leak category represents approximately half of the incidents recorded, irrespective of the size of the leak.

This last category of incidents merits special attention as it is that which has resulted in the largest releases to the environment (10 kg of uranium). The other categories of incidents essentially relate to the monitoring of special equipment (particularly the electrical and process control equipment); these categories consist of incidents which had no significant consequences for safety, with the exception of those resulting from chemical reactions involving fire or an explosion. These incidents, which reveal a typical case where a *priori* safety analysis underestimated the risk, have resulted in substantial modifications of parts of the units or their operating conditions (essentially relating to the vacuum pumping of the fluorinated residues and the "purge" unit). Being highly specific, they need not be considered at length.

As concerns the leaks of UF<sub>6</sub>, a sub-category per type of equipment and unit involved has made it possible to identify the most vulnerable equipment and units. These are the valves and Annex U. Furthermore, the frequency of the incidents correlates well with the complexity of the installations.

To obtain an idea of the relative scale of the leaks observed, quantification using two criteria has been applied :

- the quantity of UF<sub>6</sub> released from the process system (QU), resulting in the following classes (number of incidents concerned until 1992) :

class 0 for QU less than 1 gramme,  
 class 1 for QU between 1 and 10 grammes,  
 class 2 for QU between 10 and 100 grammes,  
 class 3 for QU between 100 and 1000 grammes,  
 class 4 for QU between 1 and 10 kilogrammes,  
 class 5 for QU between 10 and 100 kilogrammes,  
 class 6 for QU between 100 and 1000 kilogrammes,

to 1992
...93...
80
55
28
15
1
2

- the number of containment barriers crossed, resulting in the following categories (number of incidents concerned until 1992) :

category 1: crossing of first barrier (uranium system),  
 category 2: crossing of second barrier (cell),  
 category 3: crossing of third barrier (building).

to 1992
**169**
97
8

Breakdown of the leaks which occurred (274), on the basis of this last criterion, indicates that :

- 61% of the leaks were contained by the second barrier,
- 97% of the leaks were contained by the building.

As concerns the quantities of uranium released from the process system, only two leaks exceeded 100 kg (class 6) and in 93% of the cases the leaks were less than 1 kg.

The most significant incidents are characterized by any one of the following situations :

- more than 10 kg of uranium released from the system (class 5 and above),
- crossing of the third barrier (category 3),
- more than 100 g of uranium released (class 3 and above) combined with crossing of the second containment barrier (category 2).

So-called "major" incidents are, within this group, those in which the release of more than 100 kg of uranium (class 6) is combined with crossing of the third containment barrier (category 3).

On the basis of these definitions, 36 significant incidents and 2 major incidents are counted.

The two "major" UF<sub>6</sub> leaks occurred in March 1980, at a group isolation valve, and in September 1985, at a crystalliser valve of the Annex U "purge" unit. In both cases, the releases to the exterior were less than 10 kg.

This value is of the same order of size as the quantity of uranium which escapes annually in gaseous releases during normal operation of the plant (approximately 10% of the authorized limit).

The causes of the incidents can be divided into two broad categories, according to whether the origin of the failure was human error or a technical fault. Although it is difficult to determine which of the two categories predominates - the causes can result from a combination of the two - this classification gives the following results :

- 20% of the incidents are of human origin,
  - 75% of the incidents are of technical origin,
- and the remainder is difficult to classify.

The high percentage of incidents of technical origin appears to be a particularity of the Eurodif plant even if, over time, the percentage has tended to decrease. Concerning this point, it should be borne in mind that the two "major" incidents relate to technical faults : the rupturing of a group isolation valve bellows and the displacement of an Annex U valve gate seal.

To conclude, the feedback of experience from the Eurodif plant, concerning both incidents and exposure of staff to nuisances (an average of  $10^{-2}$  men.Sv per year -  $2.7 \cdot 10^{-3}$  in 1992) and releases of radioactive effluents (an average of 300 MBq per year for the gaseous release since 1981, date of the installation of an electrostatic filter - about the half since 1987 : 5 to 10% of the authorized limit), is globally extremely positive.

After this review of the Eurodif plant experience feedback, the main incidents and accidents which have occurred at the site will now be considered to show the lessons drawn from them.

## **2. Experience feedback from incidents and accidents**

### **The Comurhex accident in 1977**

The accident took place on 1st July 1977 in the Comurhex uranium hexafluoride conversion plant at the Tricastin/Pierrelatte site. It involved a container filled with 8.827 tonnes of liquid UF<sub>6</sub> at a temperature of around 95°C and occurred after a liquid UF<sub>6</sub> sample-taking operation.

The container was standing on a cradle on the ground under a heating device and outside the sample-taking building. The valve of the container was connected to the installation by a hose. After sample-taking had been completed, prior to evacuating the container, the staff of a new team (after shift changing) began to remove the heating device, using handling equipment. The valve, which had not been disconnected, was then torn off, which created an opening in the container of approximately 25 mm in diameter.

Liquid UF<sub>6</sub> was released for about 10 minutes. A total of 7.1 tonnes of UF<sub>6</sub> escaped, as was determined by weighing the cylinder after the accident.

To lay the cloud thus formed, 13 m<sup>3</sup> of water were sprayed on the container within half an hour. In addition, to reduce the leak rate by cooling, 600 kg of liquid carbon dioxide was sprayed after the accident as an initial emergency measure.

In total, the release of toxic vapours lasted for 45 minutes and the dense cloud formed was carried away by a 10 m/s wind.

There were no human consequences. The principal results of the readings taken in the environment indicated that :

- the quantity of uranium dispersed in the atmosphere was only a small fraction of the uranium contained in the vaporized UF<sub>6</sub> (less than 6%), the remainder having been deposited close to the source,

- the quantity vaporized was slightly less than 50% of the quantity that escaped from the container,

- the hydrofluoric acid resulting from hydrolysis of the UF<sub>6</sub> (resulting from drenching of the accident zone with water) was detectable up to 15 km downwind, whereas the uranium was deposited in the near vicinity,

- the ratio between the weights of fluorine and uranium in the contaminated soil was significantly high beyond 1000 metres.

Therefore, the main risk resulted from the formation of hydrofluoric acid. The toxicity of the uranium itself was a secondary consideration, again being one of essentially, a chemical nature (natural uranium).

The analysis of the accident naturally showed human error to be the primary cause. It being discovered that :

- there were no detailed instructions or procedures relating to a hazardous task,

- the exchange of information between successive teams carrying out a single task was inadequate,

- staff training was inadequate.

However, the consequences of this human error were amplified by the design of the installation and the ill-adapted operating conditions:

- the absence of a second containment barrier between the dangerous material and the environment,

- the need to remove the heating device which could only result in tearing the valve off the container if it were still connected to the installation,

- the absence of physical or administrative means of avoiding the handling of containers while still "hot".

These lessons were taken into consideration in the subsequent fitting out of the facility and in the design of other facilities (for instance the Eurodif plant).



### The "major" Eurodif incident in 1985

The incident occurred on 10th September 1985 in the "purge" unit of Annex U of the gaseous diffusion uranium enrichment plant operated by Eurodif-Production at the Tricastin site. The UF<sub>6</sub> leak occurred at a diameter 150 mm valve at the inlet of a crystalliser while the liquid UF<sub>6</sub> it contained was being poured into a receiving vessel, the valve in question normally being in the closed position. The leak began after a metal seal of the valve became unseated.

After expert examination, it was accepted that the operating procedure for installation of the seal, resulting in random tightening, could make unseating of the seal possible in the event of a slight distortion of the valve bonnet as observed in the valve involved. The corrective measures implemented, i.e. initially fitting travel stops to the seals of this type of valve and, subsequently, modifying these valves to ensure constant tightness, made it possible to circumscribe the cause of the incident.

However, a number of important lessons were drawn from this incident, both for the containment provided by the building and for emergency action in the event of a UF<sub>6</sub> leak.

Although the circuits were isolated within a few minutes, the incident resulted in the leakage of 400 kg of gaseous UF<sub>6</sub> into the building. The cloud thus formed crossed the second containment barrier (the cell in the building) via the seals of the doors, the overpressure dampers and the pipe penetration. This resulted in pollution of a considerable part of Annex U. Furthermore, due to the presence of slightly leak untightness in the upper part of the building cladding, hydrofluoric acid and aerosols containing uranium were released into the environment for a few hours. Less than 10 kg of uranium finally escaped.

The incident had no important human consequences; thirteen workers inhaled uranium (while removing emergency action suits), and one exceeded the allowable limit of 2.5 mg in one day, without suffering irreversible damage to his health.

Analysis of this incident has made it possible to determine measures to prevent it from occurring (see above), but also to limit the potential consequences, particularly as concerns spreading in the buildings and to the environment, and to improve emergency action :

- sealing the slightly leak untightness at the top of the building cladding,
- sealing the cell wall penetrations,
- modifying the cell doors (seal and damper),
- construction of an isolation airlock between Annex U and the overhead gallery leading to the control building and the diffusion plants,
- extending these improved containment measures to other buildings,
- installing an emergency drain system for the UF<sub>6</sub> cells, making it possible to extract a polluted atmosphere and treat it using a vent washing device,
- improvement of the emergency action suits (better sealing between the suit and the respirator, and the installation of individual means of communication),

- organizing assistance for the dressing and undressing of staff to avoid contamination and acid burns,
- better theoretical and practical training in emergency action,
- creation of mobile emergency airlocks which can be docked to a polluted building to enable access without loss of containment,
- revision of the preventive measures applied in buildings close to one in which an accident has occurred, particularly by systematically raising the alarm in buildings downwind.

### The Cogema incident in 1986

This incident occurred on 19th June 1986 in the Cogema facilities at Pierrelatte/Tricastin. It consisted of a leak of gaseous UF<sub>6</sub> from an evaporator containing a type 48Y container during transfer to a pyrohydrolysis furnace for transformation of uranium hexafluoride into tetrafluoride. The cause was a leak at a hose connecting the container to the process system.

The evaporator was of the non-mobile type, referred to as an autoclave, closed by a bayonet fitting door sealed with a joint seated by air pressure. The test pressure of the evaporator was 7.5 bar gauge. Heating was by steam circulation and the acidity of the condensates was monitored to detect any leakage of UF<sub>6</sub>.

The leak caused by a defect in the process circuit connection hose was normally detected by a drop in the heating steam condensate pH. After visually checking the cause of the leak, the container was left to discharge without heating to reduce its internal pressure. At the end of the operation, the internal pressure was 1.4 bar and 9.3 tonnes of UF<sub>6</sub> remained.

The action taken (after allowing the evaporator to cool for a few days) to close the container valve, to disconnect it from the process system and to fit a plug to the valve outlet was complicated by crystallization of the UF<sub>6</sub>. There was a gaseous release inside the evaporator, and subsequently to the exterior. This was because re-closing of the autoclave, which should have enabled containment of the leak, was prevented by the presence of a foreign object (a rag) which was dropped while action was being taken to disconnect the container.

Release to the exterior was very slight, due to the length of time for which the container was allowed to cool before action was taken. Nevertheless, it was necessary to use suction lines with filters to trap the uranium and jets of water to lay the plume thus formed.

The lessons drawn from this incident relate to :

- the hose between the container and the process system,
- evaporator equipment intended to limit the consequences of an internal leak.

As concerns the connection hose, special management measures were implemented : identification and keeping records of the number of connections used to ensure maintenance and testing after use for a specified number of times, for instance in Eurodif, after being used ten times for liquid phase transfer and thirty times for other uses.

As regards the autoclave type evaporator equipment, whose suitability was not called into question by the incident, improvements were made to the facility and a container valve remote closure device was fitted to stop any leaks affecting the section of the system downstream of the valve, and a nozzle was fitted to the evaporator to make it possible to continuously extract the UF<sub>6</sub> in it to external equipment (by a hot point/cold point), to enable subsequent action to be taken inside the evaporator.

Thus equipped, an autoclave type evaporator constitutes a suitable item of equipment for use with high capacity UF<sub>6</sub> containers.

#### Comurhex incident in 1987

This incident occurred on 12th April 1987 in the Comurhex uranium hexafluoride packing unit at Tricastin/Pierrelatte during filling of a type 48Y container from a chamber full of liquid UF<sub>6</sub>. The initial result was a slight leak of UF<sub>6</sub> at the container valve, which was detected by the atmosphere monitoring devices.

The measures taken by the operator, i.e. suspension of filling of the container and connection to a chamber maintained at a low temperature, made it possible to rapidly circumscribe the anomaly. Subsequently, during a team operation to disconnect the container, a large UF<sub>6</sub> leak occurred via the container valve, which was not completely closed (crystallization of UF<sub>6</sub>).

This incident had no significant effect on the staff or the environment and involved the dispersion of some 1200 kg of UF<sub>6</sub> inside the facility and the release into the environment of hydrofluoric acid and products containing uranium (around one kilogramme).

The cause of the first leak was a crack in the packing nut of the container valve. The action taken to limit unintentional release, the injection of CO<sub>2</sub> and the application of wet cotton wadding, helped to create a plug of crystallized UF<sub>6</sub>, making it impossible to fully close the valve which would have completely stopped the incident. Upon uncoupling of the container and fitting of the valve plug, the UF<sub>6</sub> plug failed which was the cause of the main leak.

The lessons drawn from this incident relate to the quality of the equipment used, the suitability of the procedures applied to re-obtain normal operation and the containment provided by the facility.

As concerns the quality of the valve, which was of aluminium bronze (Alloy 636) as specified in standard ANSI 14-1 covering UF<sub>6</sub> container equipment, it was possible, through expert investigations, to attribute the cracking phenomenon observed to the high mechanical stress due to the action of the packing on the valve body, under temperature (expansion coefficient is different between packing PTFE and valve alloy 636).

The intergranular corrosion due to the action of the nascent hydrogen produced by the hydrofluoric acid, resulting from decomposition of the UF<sub>6</sub> on the aluminium bronze, is an aggravating agent.

A modification of the valve standard (material of the packaging, shape of this packaging and its supports) is being suggested to the competent American authorities.

Besides, operation procedures were precised to avoid any excessive stress on the nut and the valve itself, during successive tightening of the nut and thermal cycles in the process, i.e. wrench torque and heating limitations.

As concerns the procedures and the containment of the facility, arrangements have been made to avoid uncoupling of the container if closure of the valve is not ascertained and to improve compartmentalization of the filling unit in which the incident occurred.

Indeed, it would appear on the basis of the different incidents examined above, that facilities, where large quantities of UF<sub>6</sub> are handled, must have suitable levels of containment, consisting of a number of successive barriers. Most of the lessons drawn from these incidents have resulted in the improvement of the containment and even in the installation of additional equipment for leak processing (cf. Eurodif).

The last lesson of the incident is the usefulness of CO<sub>2</sub>, not to stop a UF<sub>6</sub> leak which it is not capable of doing as the heat exchange with the UF<sub>6</sub> is insufficient, but to lay the cloud formed in the building, thus making it possible to see clearly and to neutralize the product on the ground.

.....

**BNS/OECD-NEA Symposium on the  
SAFETY OF THE NUCLEAR FUEL CYCLE  
BRUSSELS, 3-4 June 1993**

**DEVELOPMENT OF THE SILVA PROCESS**

*JP. Pervès, A. Rosengard*

Commissariat à l'Energie Atomique, Direction du Cycle du Combustible  
91191 Gif-sur-Yvette Cedex - France

**Abstract :** A brief description of french approach to long term R & D enrichment and the SILVA programme organization are given. The SILVA process is described : basic principles, laser light-atoms interaction, laser system, separation system, materials. Main facilities and some results are presented as well as some sights on economical targets and safety.

**Résumé :** On donne une brève description de l'organisation du programme SILVA dans le cadre de la R & D à long terme sur l'enrichissement en France. Le procédé SILVA est décrit : principes de base, interaction entre atomes et lumière laser, système laser, système séparateur, matériaux. On présente les principales installations et quelques résultats, avec des aperçus sur les objectifs économiques et les problèmes de sûreté.

## 1. INTRODUCTION

A general energy policy must be based on long term options. It has to ensure an energy supply in sufficient quantity, but at the same time it must be competitive and reliable, in order to avoid crises like the oil crisis and the greenhouse effect.

France has low natural resources (*oil and coal*), and therefore for a long time has had a broad approach for its energy policy : energy saving, a logical use of every source, a wide range of suppliers and reasonable domestic autonomy.

France has therefore developed for the generation electricity a very complete nuclear industry, from mining to reprocessing and radwastes management, and now has a major electro-nuclear park, with 55 power reactors, supplying 75% of the nation's electricity and representing 32% of its energy requirements (*Ref. 14*).

The modern multinational EURODIF enrichment plant in Pierrelatte in the south of the country supplies these reactors with enriched uranium as well as foreign utilities (*30% exports*). It works smoothly and has continuously been improved to reduce operating costs and to gain flexibility and longevity. Investment costs will be recovered at the turn of the century. The plant will be competitive well ahead of an aging production park, with large overcapacity, in other countries.

The world enrichment industry entered a new era two years ago with the collapse of Eastern European political system and its two major consequences for the enrichment business:

- huge stocks of military highly enriched uranium will probably be available for civilian purposes, after dilution. They can represent 10 to 20% of world needs for 10 to 15 years,
- large military production capacities, in USA and mainly Russia, will be oriented toward reactor grade uranium or will have to be shut down: they represent approximatively 8 MSWU/year, or 18% of world capacity.

Meanwhile world needs will increase only slightly during the next 15 years, apart from the Asian Pacific area, but many world governments are becoming well aware of the necessity to progressively resume nuclear energy development worldwide from the year 2000 on.

## 2. FRENCH APPROACH TO LONG TERM R & D ON ENRICHMENT

During the first half of the eighties several processes, including advanced gaseous diffusion, chemical exchange, laser photoionisation and photodissociation, and cyclotronic resonance, were simultaneously under study in France. Today R & D efforts on enrichment processes are solely devoted to laser photoionisation, currently known as SILVA (Ref. 15).

The main reason which justified this choice in 1985 was the fact that a highly selective process, such as SILVA, would probably take the lead over statistical processes such as gaseous diffusion, centrifugation or chemical exchange. This is particularly true in France where the need for new large enrichment capacities looks like it will coincide with the replacement of the EURODIF plant which could take place as late as 2010.

As a result the goal aimed at is no longer to confirm this choice, but rather to develop progressively a high performance process, looking closely at every new technology which might be appropriate in the long term. Special attention is given to the reduction of investment and operating costs for a plant which could be set up progressively, following market needs. Briefly, R & D on SILVA today is oriented toward:

- an extensive analysis of every field of basic research.
- a modular organisation of the process, for both laser and separator sub-systems and related workshops: the benefit of such an approach is :
  - . R & D facilities of reasonable size and construction and experimenting costs,
  - . demonstrations can be achieved separately for each sub-system, the general demonstration being built like a puzzle,
  - . breakthroughs resulting from advanced technology, particularly in the fields of optics and materials, can be integrated more easily and even at a late date,
  - . industrial deployment can be progressive.
- limited fully integrated experiments, oriented towards the separation cell optimization (enrichment and production).
- the development of a general process model, including operational and economical data, fed with qualified physical and chemical models and related computer codes.

The SILVA process is periodically assessed from both scientific and industrial points of view in close cooperation with COGEMA. A general assessment will be made between 1996 and 1997. It will include demonstrations related to each of the main process functions:

- enrichment performances (*product and tail assays, production capacity*),
- handling of uranium fluxes in a separator,
- long term operation of laser chain and laser system,
- reliability of specific components and materials in process conditions,

as well as an evaluation of the economics of an industrial application with qualified and advanced technologies.

The date of construction of a fully integrated demonstration pilot plant, at near production size for the main components and sub-systems, will then be decided, as required by market conditions. It will be set up progressively and will include the most advanced designs.

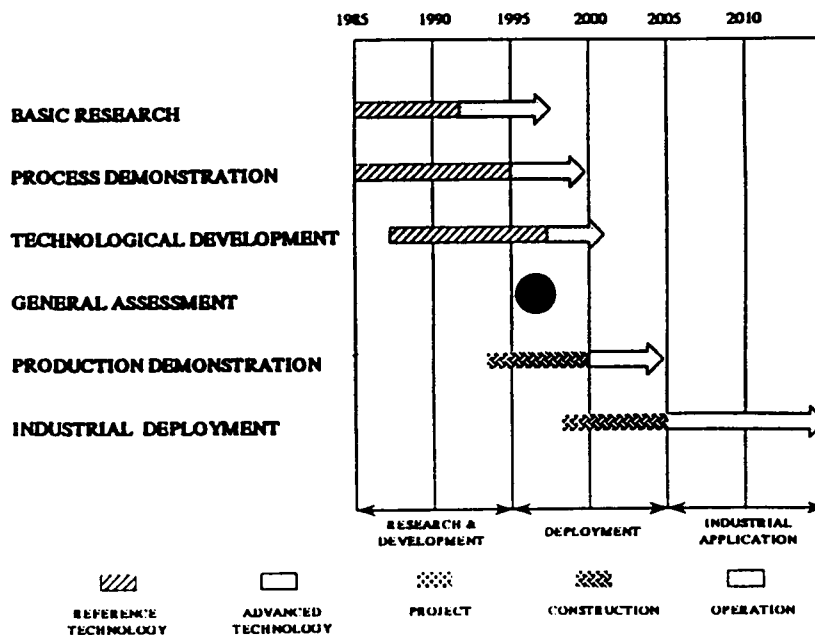
Fig. 1 : SILVA general schedule

### 3. SILVA PROCESS DESCRIPTION

#### 3.1 Basic Principles

The SILVA process rests on the difference in the excitation frequencies of the electronic layers (*electron transition*) between isotopes of an element. Thus, the light emitted by a laser may be tuned exactly on these frequencies resulting in the excitation of the chosen isotope, namely isotope U235. This excitation leads to the ionization of the atom. Subsequently, ions are separated by an electrical field and received on dedicated collectors.

A laser isotope enrichment facility includes :

- a laser unit (*pump and dye lasers*) producing light beams with perfectly tuned wavelengths which raise uranium to the ionized state,
- a separator in which uranium is vaporized. The vapor is irradiated by the laser light, the uranium 235 isotope is ionized selectively and extracted by an electric field.

The two streams of enriched and depleted uranium are collected separately in ingot moulds.

Fig. 2 : Photoionisation of the atomic

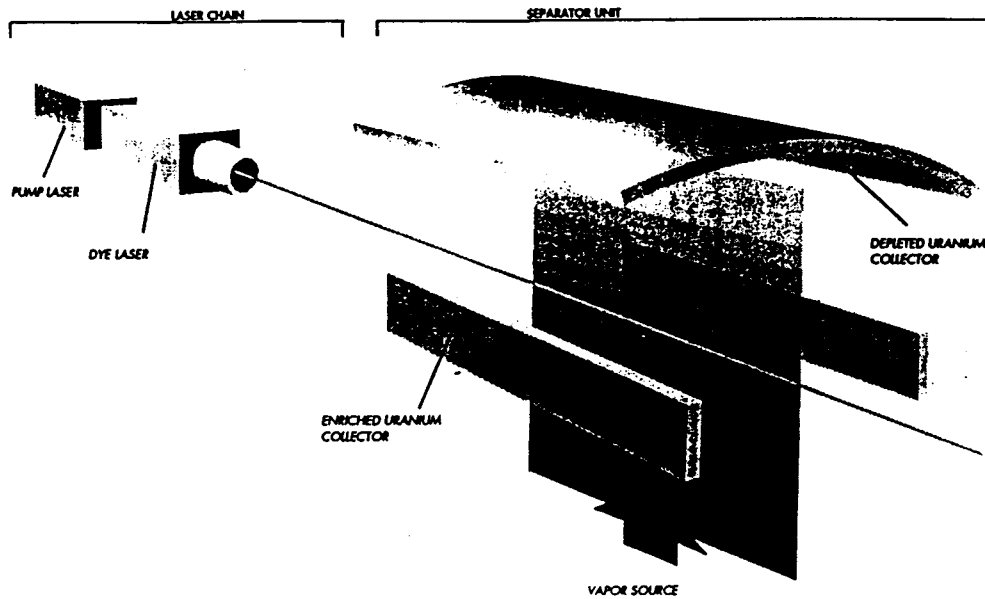

### 3.2 Laser light-atoms interaction

To be ionized, the U 235 atom must receive an energy at least equal to 6,18 eV. This energy is supplied three wavelengths, each contributing 2 eV, located in the red-orange domain ( $0,6 \mu\text{m}$ ). This option is therefore "three-step photoionization scheme". However, a sizeable number of uranium atoms lying at a level slightly above the fundamental (*metastable level*), an extra wavelength is required to carry them through the first step. In a three-step scheme, it is therefore necessary to supply four wavelengths. The choice of the light mix, called photoionization scheme, governs the type and number of laser units to be put in operation and globally the laser power required for a given enriched uranium production. These choices are thus of paramount importance as they bear largely on the final economics of the process.

Figure 3

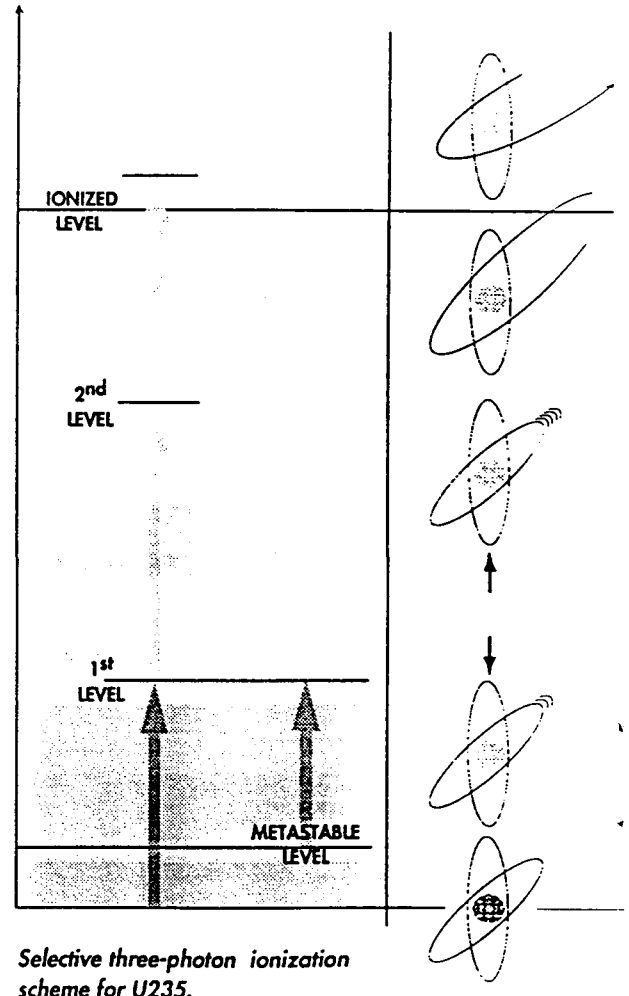

Selective three-photon ionization scheme for U235.



### 3.3 The laser system

Fig. 4 : Schematics of the SILVA laser unit

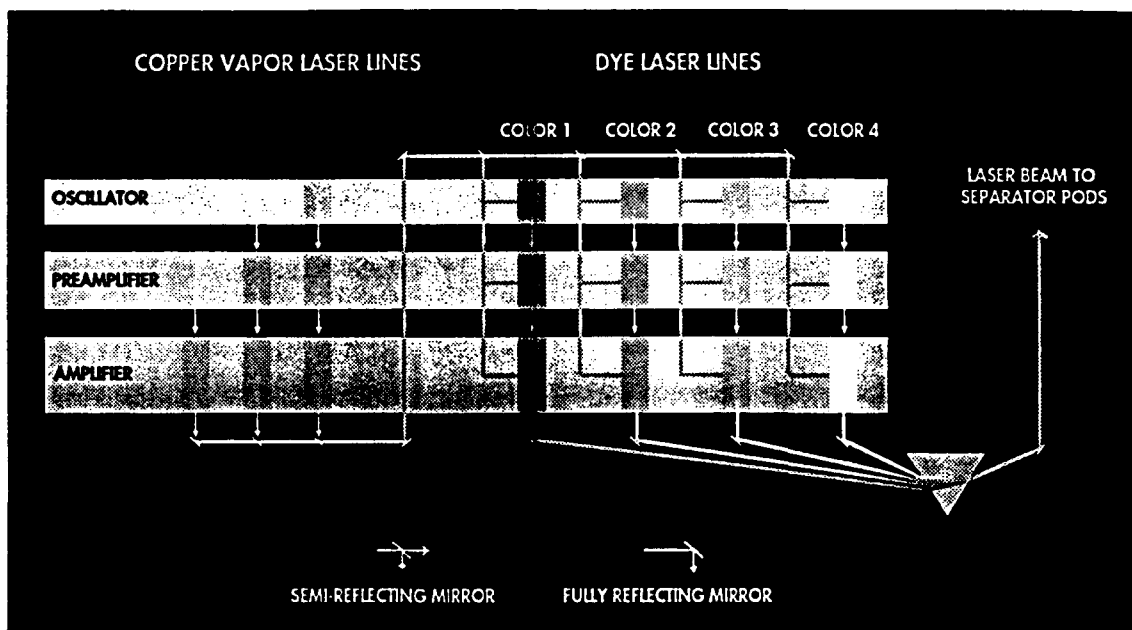

The power required for system operation is supplied by copper vapor lasers selected for their operation at high repetition rate (5 000 pulses per second) and their potential for power scaling up. These lasers, which generate photons with a fixed energy, supply or optically "pump" dye lasers which in turn generate photons with a wavelength exactly adjusted to the resonant energy of uranium 235. For the separator system efficiency, it can be useful to increase the laser system pulse repetition rate to a multiple of the LVC repetition rate (*temporal multiplexing*).

### 3.4. The separator system

Uranium atoms, to be ionized and then separated, must be present as vapor. Thus, metallic uranium, located in a crucible and submitted to a high energy electron beam, is vaporized at a very high temperature (3 000 °C). The electron beam from an electron beam gun located under the crucible is bent towards the surface of the uranium bath by means of a magnetic field. The gun, housed in the separator pod, is connected to a DC high voltage source (*several tens of kilovolts*).

The vapor travels within a vacuum chamber, the separator pod, where the ionized U235 atoms are separated by means of an electric field from the uranium 238 left in a neutral state. The separator has a fourfold role :

- overall enclosure of uranium vapor,
- accurate definition of the volumes devoted to the interaction between vapor and light energy bearing photons,
- condensation as liquids (high temperature) of the streams enriched and depleted in uranium 235.
- recycling to the crucible of the liquid condensed prior to interacting with photons (reflux).

The laser system supplies laser beams through an "optical management system" to a number of separation cells and separator pods.

Fig. 5 : Uranium flow in the separator

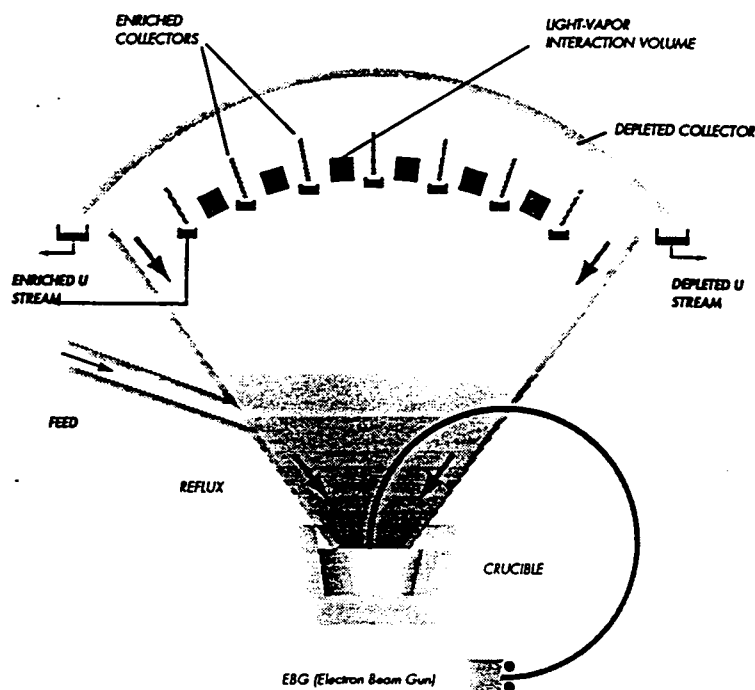

### 3.5 Materials

The design of the separator pod must take into account an operation at high temperature with electrical voltages and a corrosive liquid metal. Temperature and corrosion requirements together with sizeable throughputs in a separator (*in a plant, hundreds of kilograms per hour of uranium to be vaporized*) have led to the use of various materials for collecting and streaming structures. These materials will depend on the nature and temperature of the liquid metal : pure uranium (*melting temperature 1130 °C*) or alloys. For instance the Uranium-Iron alloy has an eutectic point at low temperature (*725 °C, 34 % Fe atoms*). Advantages from low temperatures must be balanced with complexity of alloy management.

## 4. GENERAL OVERVIEW OF MAIN RESEARCHES AND FACILITIES

### 4.1. Basic researches

The SILVA process optimization requires a large number of basic researches : uranium spectroscopy, light matter interaction, evaporation, vapor flow, plasma physics for ions extraction, condensation and collection mechanisms. Some details on this basic researches are available in Ref. 1 to 5.

### 4.2. Technological development

A wide range of experimental facilities have been devoted to component and process function development, in Saclay and Pierrelatte.

#### **Separator system**

Special attention has been given to material testing under process condition. For instance the CORDY facility (Ref. 6) allows testing of various components under realistic vapor conditions, and gives access to corrosion and leaching effects and to flow conditions on long-standing tests .

Uranium vaporisation is studied with various electron beams and crucibles in high power facilities and facilities devoted to various physico-chemical conditions .

Ion extractors and collectors are experimented on dedicated facilities, with high temperature super-structures.

Complete liquid metal management, including uranium source and gestion of the three fluxes of uranium is tested on the MAEVA facility, for long-lasting runs, over 100 hours.

From a general point of view components will be tested in the next years between half and full process scale on these benches.

### Laser system

Several pumping systems are still conceivable for industrial use, including solid state lasers. Nevertheless the main effort has been carried out on copper vapor lasers (CVL), developed by CILAS Company. Fig 6 shows the development schedule, and points out the time necessary to achieve production capability for the standard production of reliable lasers after the first prototype success. Today 100 W CVL are commercialized and 315 W have been obtained on prototype lasers (Ref. 8). The next generation, 400 W CVL, will be using solid state power supplies developed (Ref.9).

Fig. 6 : Development and production of CVL

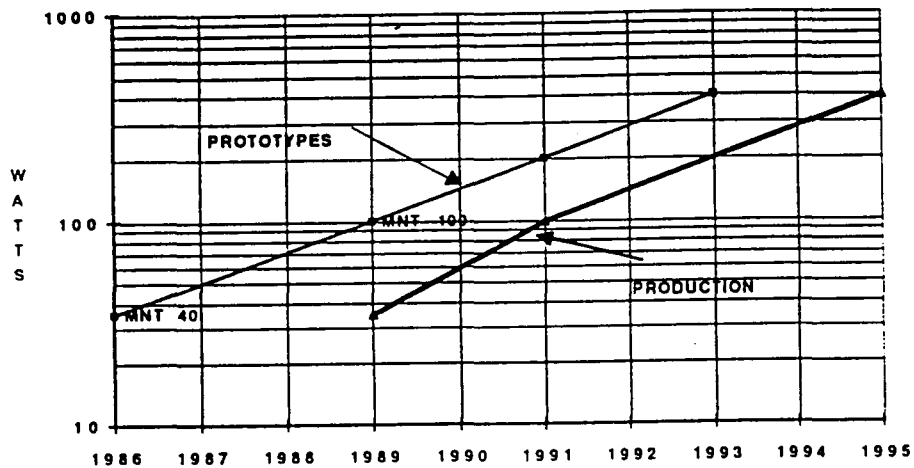

Dye lasers have been conceived by CEA and are experimented on specific laser chains at various repetition rates (Ref. 10). Fig 7 gives the development situation of qualified power amplifiers, this development being adjusted to pilot process facility needs.

Fig. 7 : Dye laser amplifiers development

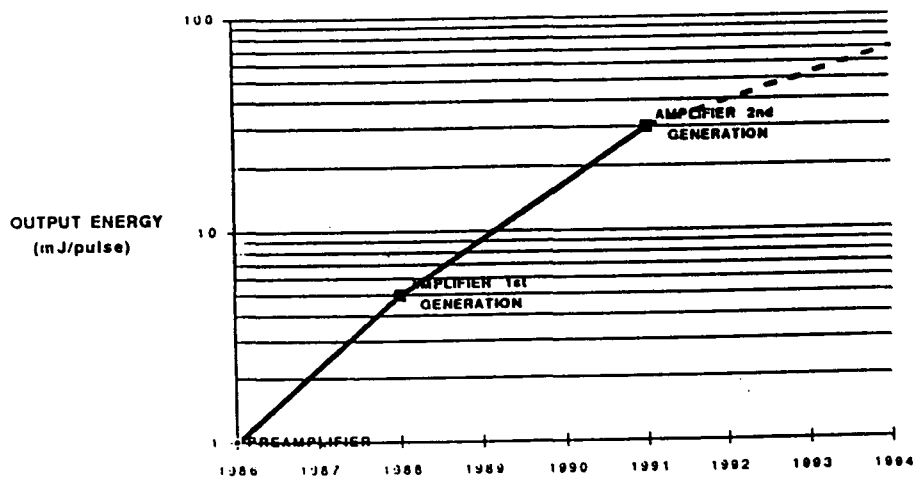

Meanwhile optical components for pumping and adjusted light have been developed in cooperation with university and CNRS laboratories and industrial companies such as SAGEM and MATRA. Specific benches have been devoted to optical components testing (Ref. 11).

#### 4.3. Process Pilot Facility A2

This facility includes a complete four wavelengths laser system, and a separator. It has been working for 6 years and an extension, ASTER, with additive laser power (ten times higher) and a larger separator is under way. Its goal is to test the extractor/collector system at process scale and under representative physico-chemical conditions. The tests involve:

- analytical and parametrical experiments on photoionisation, plasma, extraction and collection,
- separative tests with process vapor densities and laser fluence.

Enrichment assay up to 5,5% and production between 1 and 10 g/h have been achieved.

#### 4.4. LACAN, a general simulation code

The first target of LACAN computer code (Ref. 13) is to simulate global separator performances through a modelisation of the light distribution system and vapor production and selection.

The code has three main applications :

- confrontation to the results of experiments, mainly on the process pilot, for validation of the physical models introduced in this code,
- tool to design new facilities and production plant,
- process and economics optimization.

For this last target technological and operational data are added as well as cost functions and general economical assumption.

### 5. ECONOMY

Our target for SILVA separation cost is 350 F/SWU for a several millions SWU/year plant with a 5 % <sup>235</sup>U product and a waste fraction under 0,2 % in one step. More than 100000 SWU/year per separator pod gives an idea of the high compacity of this process. The SILVA process requires metallic uranium : its production (*UF6 cycle*) could adapt to the present industrial. But it would be more advantageous, starting from uranium concentrates, to go through more direct transformation steps at the front end, and produce directly sinterable oxides at the back end. Such a cycle, shorter than the conventional UF6 way, should, in due time, give an extra economic advantage.

### 6. SAFETY

A part of the research and development programme is dedicated to safety. This programme hinges on following points :

- A modelization numerical code for the evaporators in incidental or accidental situations.
- Experimental test on water- liquid uranium reactions, as they can occur along the cooling system (*for instance in the crucible*).
- Other experimental runs on hot structures and water interactions will soon begin.
- The aerosols generated in evaporators and structures refurbishment facilities are characterized (*size, concentration, etc.*). This work is completed with toxicological investigations : *in vitro (cellular tests)* and *in vivo (rats)*.
- Systematic analysis of the various occurred incidents (*water or air entrance, small uranium fire*).

The general safety rules adequate to industrial SILVA facilities and incidents classification will be established later.

## 7. CONCLUSION

The SILVA program in France is conducted cautiously, step by step, in order to benefit most economically from the most advanced technology.

Close relationship between the Atomic Energy Commission and COGEMA, the world leader in the nuclear fuel cycle industry, ensures a good analysis of the required technical program. The results achieved up to now give them and their industrial partners confidence in the potential success of this innovative process.

## REFERENCES

### SPIES INTERNATIONAL SYMPOSIUM 1993. LASER ISOTOPE SEPARATION (*Janvier 1993*)

1. A. PETIT "The spectroscopy of uranium within the "SILVA" program".
2. R. AVRIL, A. GINIBRE, A. PETIT "On the hyperfine structure in the configuration F3D5/2 of uranium"
3. Ph. KUPECEK, M. COMTE, J. de LAMARE, A. PETIT, "Ionization yield in a three step photo-ionization process of an optically thick atomic column : numerical modelization and experimentation in thulium"
4. JP. MAGNAUD M. CLAVEAU, N. COULON, Ph. YALA, D. GUILBAUD, A. MEJANE, "TRIO-EF a uranium general thermal hydraulic computer code applied to the AVLIS process"
5. F. DONEDDU, "Numerical experiments of ion extraction in laser separation using a particle-mesh simulation"
6. B. LORRAIN, R. SOBRERO, "Presentation of the CORDY pilot plant"
7. M. BERARDO, J. MARCELLIN, "Flows studies on various uranium material systems"
8. J. CHATELET (Cilas) and A. BETTINGER, M. NEU, J. MAURY (CEA), "Copper vapour laser development for SILVA"
9. D. CHATROUX, J. MAURY (CEA) and B. HENNEVIN (GEC-ALSTHOM), "IGBT : a solid state switch"
10. D. DOIZY, J. JARAUDIAS, E. POCHON, G. SALVETAT, "Dye laser chain for laser isotope separation"
11. H. PIOMBINI, C. GALLOU, P. ISNARD, "Visible laser facility for optical components"
12. N. CAMARCAT, A. LAFON, J.P. PERVES, A. ROSENGARD, G. SAUZAY "Atomic vapor laser isotope separation in France"

### OTHERS REFERENCES :

13. S. GOLDSTEIN, JP. QUAEGBEUR, "International Symposium on isotope separation and Chemical exchange uranium enrichment - Tokyo - CEA-CONF 10495 (1990)
14. J-Y. BARRE, "Uranium enrichment : a success today, an asset for the future" USCEA - International Enrichment Conference - Washington (1991)
15. JY. BARRE, JP. PERVES, "La recherche dans le domaine de l'enrichissement SILVA : la séparation isotopique par laser" - Annales des Mines (Octobre 1992).

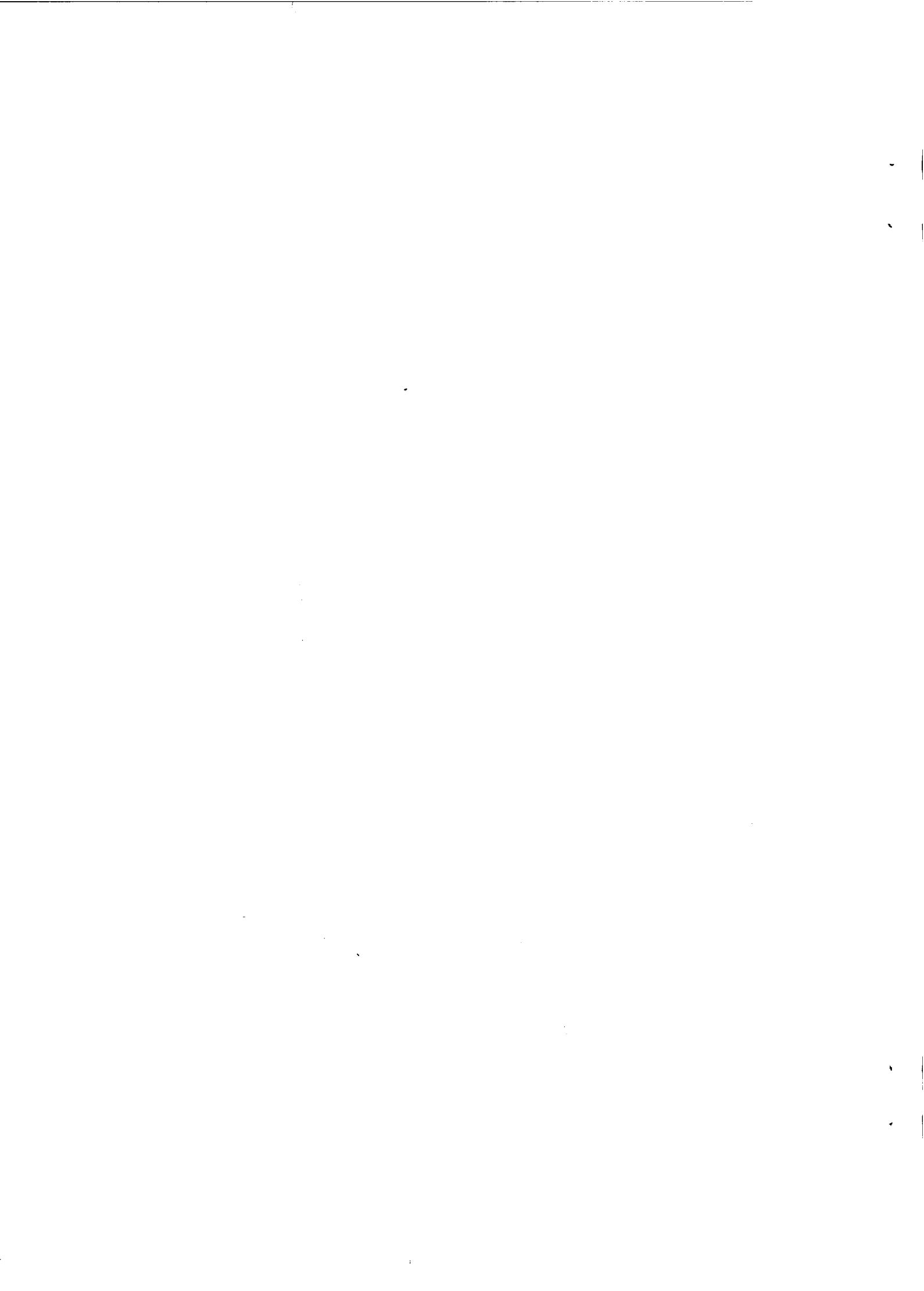



DESSEL, April 14th 1993.  
DA/30/15.645/PVD

BNS/OECD - NEA  
SYMPOSIUM ON THE SAFETY OF THE NUCLEAR FUEL CYCLE  
BRUSSELS 3-4 JUNE 1993

**SOME CONCRETE SAFETY ASPECTS  
OF THE FUEL MANUFACTURING  
AT FBFC International**  
P. VAN DENHOVE, FBFC Int., deputy plant manager.

ABSTRACT:

FBFC International, with its plant at DESSEL, Belgium, performs all the manufacturing steps of the uranium fuel assemblies starting with the low enriched uranium oxide powder, and also the last assembling step of MOX fuel assemblies. More than 13.000 fuel assemblies of several designs, representing about 3,5 million rods or 7.000 MT of heavy metal, constitute the experience of FBFC International. The highest external radiation exposure appears at the final assembling, due to the large quantities of heavy metal present, while internal irradiation could occur at the pelletizing area.

The fissile material present must be managed so as to avoid criticality. In the plant's 30- year lifetime there were no violations of legal limits on workers radiation exposure or environmental releases.

RÉSUMÉ:

FBFC International effectue, dans son usine de Dessel, Belgique, toutes les étapes de fabrication des assemblages combustibles à uranium, au départ de la poudre d'oxyde d'uranium faiblement enrichie, et également l'étape finale (l'assemblage) pour les assemblages MOX. Plus de 13.000 assemblages combustibles de diverses conceptions, soit environ 3,5 millions de crayons ou 7.000 tonnes de métal lourd, constituent l'expérience de FBFC International. Les doses d'irradiation externe les plus élevées apparaissent à l'étape d'assemblage, du fait des fortes quantités de métal lourd présentes, alors que l'irradiation interne peut plutôt se produire au pastillage. La matière fissile présente doit être gérée de façon à éviter toute criticité.

Au cours des 30 ans d'existence de l'usine aucune limite légale, de dose d'irradiation au personnel ou de relâchement dans l'environnement, n'a été dépassée.



**FRAMATOME**  
FABRICATION COMBUSTIBLE

BNS Conference. June 4th. 1993

## 1. INTRODUCTION

### 1.1. FBFC France

FBFC SNC (Franco - Belge de Fabrication de Combustible) is a French company with its seat in PARIS. Its main shareholder and industrial operator is FRAMATOME, with 51% of the stock; the second shareholder is COGEMA with 49%. The main activity is the manufacturing of PWR  $UO_2$  fuel assemblies, with all steps from low enriched  $UF_6$  to the complete fuel assembly; the capacity is about 1.600 MT of U-content per year, with all designs from 14 x 14 to 18 x 18 .

FBFC SNC operates two factories in France (ROMANS - SUR - ISÈRE and PIERRELATTE). The main destination of the production is EDF, but more than 15% of the production goes to other utilities located in Belgium, Sweden, Germany, etc.

### 1.2 FBFC International

FBFC International is a wholly owned Belgian subsidiary of FBFC SNC. FBFC International's plant is located in DESSEL, Belgium, with a capacity of about 500 MT U content per year and a workforce of around 350 persons. The main products, which also constitute the manufacturing steps, are as follows:  $UO_2$  pellets,  $UO_2$  fuel rods, fuel rod - and guide thimble plugs and springs,  $UO_2/Gd_2O_3$  pellets,  $UO_2/Gd_2O_3$  fuel rods, brazed spacer grids, welded guide thimbles, skeletons,  $UO_2$  fuel assemblies. The  $UO_2$  fuel assembly shop is also equipped to perform the assembling of MOX fuel assemblies.

The  $UF_6/UO_2$  conversion, end nozzle and, zircaloy spacer grid manufacturing are performed in the French FBFC - factories.

It should be mentioned that, in the area of safety as in other areas, FBFC benefits from the nuclear experience of its shareholders FRAMATOME and COGEMA, but also from experience exchange between the three FBFC - factories. Finally, the vicinity of FBFC International, BELGONUCLÉAIRE and the MOL NUCLEAR STUDY CENTER facilitates operation and emergency planning.

### 1.3. FBFC International : manufacturing experience

FBFC International has produced more than 13.000 fuel assemblies ready for use in the power plants, but also more than 8.000 control rod or thimble plug assemblies. The 13.000 fuel assemblies represent about 3,5 million fuel rods containing about 7.000 MT of uranium in the form of 1 billion of uranium dioxide pellets. The pellet designs include all types from 14 x 14 to 18 x 18 grids.  $UO_2/Gd_2O_3$  fuel is also manufactured.



The assembly designs fit to all PWR power plants, from the older inconel spacer grids to the recent advanced designs (FRAMATOME's AFA and now AFA 2G, or second generation AFA).

About 400 MOX fuel assemblies were also manufactured, with current designs 17 x 17 AFA, 14 x 14 , and 16 x 16 (AFA or German design).

#### **1.4. Safety Record of the manufacturing plant**

The large quantities listed hereabove were manufactured since the start-up of FBFC in 1973. The plant itself started up in 1961 and operated on a smaller scale, for foreign and indigenous markets, like BR<sub>2</sub>, Venus, Vulcain, sometimes with U metal enriched up to 93% U<sub>235</sub>.

From that start-up in 1961 to the actual situation in 1993 there was no single violation of the legal limits on worker radiation exposure or environmental releases.

## **2. POTENTIAL RISKS AT FBFC INTERNATIONAL**

### **2.1. Specific conventional risks**

Three types of specific hazards not related to fissile material have to be mentioned.

#### **2.1.1. Chemical**

The laboratory reactants require a special safety surveillance. Many chemicals, mostly with H<sub>2</sub>NO<sub>3</sub>, NH<sub>3</sub> and H<sub>2</sub>O<sub>2</sub>, are also present in the wet uranium recycling workshop, where uranium-scrap is segregated from the impurities with a dissolution / precipitation process.

Finally, several reducing furnaces work with H<sub>2</sub>, with the associated precautions.

#### **2.1.2. Zircaloy fire**

Zircaloy can burn in air, specially in the form of powder or chips. Zircaloy shavings are formed at three manufacturing steps: zircaloy bar machining to plugs for fuel rods or thimble guides, zircaloy tube cutting (for example for weld repair or length adjustment), and fuel bundle assembling, due to the friction between fuel rods and spacer grids. Appropriate safety actions mitigate these risks.

### **2.1.3. Radiation sources other than fuel**

Automated processes require several radiation sources : X-rays for welds, neutron - and gammascanning for enrichment and other internal characteristics of the fuel rods, laser sources for metrology or identification engraving.

These sources are managed in a way similar to the non - nuclear industry: shielding, periodical testing, personnel training and monitoring, etc.

## **2.2. Radiation exposure in normal operation**

### **2.2.1. External radiation exposure of workers**

Natural uranium and its daughter products are alpha, beta and gamma emitters. Alpha radiation being cut off by the skin, the beta rays being rather low, the main contributor to external exposure is the gamma radiation. The workshops which are cause for concern are first all storages (powder, pellets, rods and assemblies), with the assembly storage being the main source because of the huge uranium mass available.

Next, the manufacturing areas for pellets, rods, assemblies, and the uranium recycling unit.

MOX fuel is present in the assembling workshop and the assembly storage; the alpha and beta rays are shielded off by the rod cladding, so only gamma rays and neutrons are remaining.

Because of selfshielding effects the neutron contribution at the assembly stage is higher than the gamma rays, this will even increase when the recent ICRP - recommendations will become legal (neutron factor doubled).

### **2.2.2. Internal radiation exposure: contamination**

The main path for contamination is inhalation of airborne particles which then produce lung damage by alpha rays.

The uranium aerosols can occur until the fuel rod is tight, mainly in the powder and pellet-storage and pellet-, fuel rod- and uranium recycling workshops. Here also the last ICRP recommendations tend to strengthen the rules: the maximum allowable concentrations would be divided by a factor of about 3. Preparing to meet these recommendations without sacrificing the flexibility and the competitive edge is one of the top priorities at FBFC.

Maximum concentration limits also exist for wastes and effluents; the peak values reached remain however far below the legal limits: fresh fuel manufacturing sets no challenge for the environment.

The MOX fuel rods arriving at FBFC International have been checked for external cleanliness prior to shipping and do not bring any contamination threat in normal operation.

### **2.3. Incidental situations**

The incidental situations are covered by internal and external emergency plans. Besides the "classical" cases like fire, flooding, etc., two specific nuclear hazards have to be mentioned: contamination and criticality.

#### **2.3.1. Contamination**

As already cited the alpha emitting uranium (long lived, low solubility in oxide form) must be taken into account especially for airborne particles; this concerns the workers more than the environment: natural uranium has a low specific activity.

During incidental situations one or several MOX rods can be broken and release some active material. Here again the aerosol path has to be closely analysed.

However, the MOX is in the shape of sintered pellets, i.e. a solid ceramic, where only a small fraction of the material can become airborne. Here again the environment will receive a smaller challenge than the workers in the immediate vicinity of the incident.

#### **2.3.2. Criticality**

A second specific case is an unwanted criticality, caused by the mass of fissile material present in the workshops and storage rooms, although the enrichments present are low.

The fissile material can be the uranium dioxide, from the powder storage till the assembly storage, but also the uranium solutions at the uranium recycling workshop, or the MOX rods or assemblies.

The moderator involved in the criticality can be water, during cleaning operations, or heating or cooling liquids, or fire extinguishing materials, or organic compounds such as wood or plastics. Even concrete may act as moderator with its content of crystallized water.

## **3. SAFETY MEASURES**

### **3.1. Organisation**

The conditions for a safe operation are derived from external norms and regulations (international, national or local) and from the license conditions. They are translated into internal norms and procedures.

Surveillance on implementation of the operating conditions is performed by the Safety Authorities, the Recognized Supervisory Body and FBFC's Safety Department.

Besides its classical roles of surveillance, training, emergency planning, etc., the Safety Department is currently starting to implement the principles of Total Quality Management : a Safety Assurance Section, in charge of organisation aspects, systematic search for preventive rather than curative actions, small incident reporting and analysis, and integration of first level safety tasks in the other departments.

### **3.2. External radiation exposure**

The monitoring actions concern dose rates and personnel dosimetry (gamma for all plus neutrons for MOX areas); the effect of the sources other than fuel are also integrated.

Shielding is not necessary for low enriched natural uranium; for reenriched retreated uranium, for which FBFC Romans holds a license, some shielding proves necessary.

Individual shieldings like lead skirts, lead gloves and lead glasses are used in the MOX assembly area (manufacture and storage): their shielding efficiency is significant for the gamma rays.

Collective shieldings are also used in the MOX area, mainly consisting of successive layers of plastic, cadmium, lead and aluminum in order to slow down and capture the neutrons and absorb the gammas. Also more and more operations get automated in order to allow separation of operators and fuel. Among the last automations are equipment steered by personal computers, camera surveillance and inspection, engraved bar coding for traceability of fuel rods instead of labeling.

### **3.3. Internal contamination by uranium**

Monitoring is performed by concentration measurements in air and liquids, surface contamination measurement on hardware and personnel, and internal contamination measurement for the personnel. A dynamic confinement is guaranteed by a cascade of underpressures: global workshop underpressures but also local machine extractions.

The collected air will pass through one or more absolute filter batteries. Individual dustmasks are used during special operations like maintenance or cleaning between campaigns of different enrichments.

High frequency cleaning is also used, in function of the accumulated experience. Any progress in the field of air and surface workshop contamination is mainly empirical: only the experience allows to design new equipment; examples are pneumatic  $U_3O_8$  powder transport and freezing of grinding sludge in order to facilitate its handling.

### 3.4. Criticality

All fissile material areas are under surveillance of a centralized criticality detection system; the detection logic is based on the "2 out of 4" principle. There are also individual and area dosimeters. Avoiding criticality first requires a thorough neutron physics study of the workshop configuration; mass and geometrical limitations are derived from this design study. As far as possible such limitations are built in the equipment or automatically warranted.

Also, the quantities of moderator material present must be controlled. Neutron absorbing materials, such as Cadmium or Boron are sometimes used to obtain the required antireactivity.

In the few remaining cases where the safe geometry cannot automatically be warranted, procedures and administrative surveillance have to guarantee the physical separation of material needed to avoid criticality.

### 3.5. Incidental contamination: incident 23/11/92

#### 3.5.1. Fuel assembly bench description: see sketch in appendix

The bench consists of:

- a support bench with clamps to secure the skeleton
- a magazine filled with cleaned rods in their proper locations
- an automatic pulling machine

The pulling bench has first to send pincers through the skeleton. The pincers then grab the fuel rod bottom end plugs to pull the rods into the skeleton.

To avoid damaging the skeleton with the pincers, protective caps have to be placed on the pincers before they enter the skeleton, they are then removed when the pincers are through.

Formerly the caps were removed by hand.

However for the MOX fuel the hands of the operator were receiving a small but definite amount of radiation.

To avoid this FBFC designed an automatic device to remove the caps.

#### 3.5.2. Incident description

The workshop was beginning the third assembly of a MOX reload for EDF.

When pulling the first row of rods into the assembly, one rod was lost by its pincers. The automatic sequence was not interrupted, so the cap removing mechanism began to move to take its position for the next row of rods, hitting the rod remaining half way in the skeleton.

The fuel rod, with approx. 4,5 % Pu, was broken and the grinding dust (the MOX - pellets are dry ground) was blown up by the fuel rod internal helium pressurisation.

The dust was carried away with the ventilation air current and spread around inside the building.

Thanks to the absolute filter system the environment was not concerned by the incident.

### **3.5.3. Incident treatment**

The internal emergency plan was immediately put into action. The national Safety Authorities and the Recognized Supervisory Body were promptly informed, the expert of the Supervisory Body was on site within one hour; the further treatment of the incident was accomplished in full cooperation between FBFC's Safety Department and the Supervisory Body, and the Safety Authority when needed. The whole personnel of the affected building was evacuated and underwent a thorough contamination counting of their belongings and exposed body-parts.

Eight workers showing slight external contaminations then underwent a thorough internal contamination assessment; the external contaminations were easily removed by washing; at the end, only one worker - the operator of the faulty machine - had a significant internal contamination. The cumulated radiation dose which will be received by this operator due to this contamination will however be well under the legal yearly limit of 50 mSv.

The broken rod was removed the very same day by FBFC's own intervention team and stored in a leaktight container.

The following days were devoted to a detailed mapping of the contamination.

The cleaning operations started early december; being only very slightly contaminated i.e. around the severe internal Pu threshold, the uranium (pelletizing and rod manufacturing) areas were easily able to restart in the course of december.

In the assembling hall a first zone was cleaned end of december, then physically separated from the rest, in order to be used as a storage room for the decontaminated material. The bench where the incident occurred was protected by a greenhouse in underpressure: the classical cleaning operations could be performed in the remainder of the assembling hall in parallel to the more difficult thorough decontamination of the assembling bench.

The start - up of UO<sub>2</sub> fuel assembling was allowed mid february 1993. In parallel with this start-up, appropriations associated with the lessons learned progressed, and allowed a restart of the MOX production early april 1993.

#### **3.5.4. Lessons learned and implementation**

The first lesson concerns the design of ventilation systems. The air formerly was impelled towards the assembling area (not contaminated in normal operation), finally went directed to the pelleting areas along with the cascade of air depressions, before extraction and absolute filtration so small but measurable quantities of Pu were found in the pellet and fuel rod areas.

Presently, the fuel rod testing and skeleton area is separated from the uranium area: the assembling area and assembly storage room form new separated compartments, equipped with absolute filters (in series with the existing ones). The extraction systems are located more closely to the potential aerosol sources.

The machines were also equipped with additional electronic and mechanical safety devices. Training sessions including all safety aspects have been organised for the workforce. The assembly workshop being multi-design, check - lists allowing an exhaustive verification of safety and quality start-up conditions for each design have been established.

Risk analysis will be used in order to track the possible combinations of failures. Last but not least, and this is the conclusion, safety is certainly not an item that can be completely solved from the office room, and FBFC wants to implement the Kaizen philosophy to safety: small but continuous improvement steps initiated by the operator level (by individual suggestions or teamwork). Building on experience can be more efficient than expensive new works.

---



# FUEL ASSEMBLING BENCH

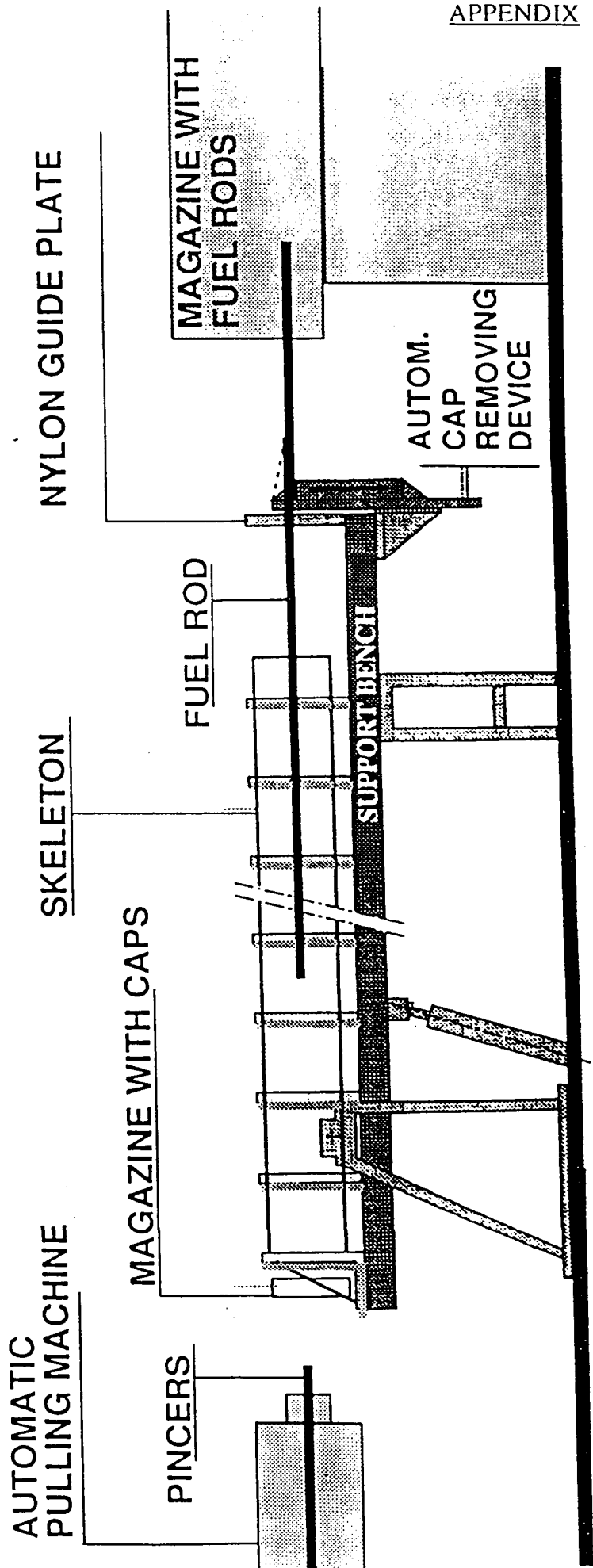





BNS/OECD-NEA Symposium on the  
SAFETY OF THE NUCLEAR FUEL CYCLE  
BRUSSELS, 3-4 June 1993

OPERATIONAL AND SAFETY ASPECTS OF  
MOX FUEL FABRICATION

J. van Vliet - E. Pelckmans  
BELGONUCLEAIRE N.V.

ABSTRACT :

Since the start of the industrial production of MOX fuel at BELGONUCLEAIRE in 1986, about 186 ton MOX involving more than 9 ton plutonium have been manufactured in Dessel. This paper reviews some aspects of MOX fuel fabrication that influence significantly the MOX plant operation and safety. This includes not only the characteristics of the plutonium itself as well as some characteristics of the MOX product but also external factors like the possible regulatory evolution along the lines of the new ICRP recommendations.

RESUME :

Depuis le démarrage en 1986 de la production de combustible MOX à l'échelle industrielle, environ 186 tonnes de MOX correspondant à plus de 9 tonnes de plutonium ont été fabriquées à Dessel. Cette présentation passe en revue quelques aspects de la fabrication du MOX qui influencent de manière significative l'opération et la sécurité de l'usine MOX. Ceci inclut non seulement les caractéristiques du plutonium lui-même ainsi que certaines caractéristiques du produit MOX, mais également des facteurs extérieurs comme l'évolution réglementaire possible dans le sens des nouvelles recommandations de la CIPR.

BNS/OECD-NEA Symposium on the  
SAFETY OF THE NUCLEAR FUEL CYCLE  
BRUSSELS, 3-4 June 1993

MOX FUELS

THE FUTURE MELOX PLANT, DESIGN AND SAFETY ISSUES.

Th. Charles/B. Darbouret  
Institut de Protection et de Sûreté Nucléaire  
Département d'Evaluation de Sûreté  
IPSN/CEA/Marcoule (France)

**Abstract**

French experience of the fabrication of plutonium-based nuclear fuels is considerable. As early as the sixties, the Cadarache plutonium technology workshop began producing the first fuels of this type. A rapid review of the operating experience feedback from this installation is made, covering the fast reactor fuel fabrication lines and a pressurized water reactor MOX fuel fabrication line. As the production capacity of this installation is insufficient to meet the French demand for MOX fuel, the decision has been made to build a new plant. This has a design capacity of 115 tonnes of mixed uranium and plutonium oxide fuel per year, and is under construction at the Marcoule site. The safety principles adopted in this plant, which is named MELOX, are described. Its design benefits from feedback of operating experience from the Cadarache workshop.

**Résumé**

L'expérience française en matière de fabrication de combustibles nucléaires à base de plutonium est importante. En effet, dans les années 1960, l'atelier de technologie du plutonium de Cadarache produisait les premiers combustibles de ce type. Une rapide présentation du retour d'expérience d'exploitation de cette installation, qui comprend, outre des lignes de fabrication de combustibles pour les réacteurs à neutrons rapides, une ligne de fabrication de combustibles MOX pour réacteurs à eau sous pression, est effectuée. La capacité de production de cette installation ne permettant pas de subvenir à la totalité des besoins français en matière de combustibles MOX, la construction d'une nouvelle usine a été décidée. D'une capacité annuelle de production de 115 tonnes d'oxyde mixte  $UPuO_2$ , elle est en cours de réalisation sur le site de Marcoule. Les principes de sûreté retenus pour cette usine, baptisée MELOX, sont présentés. Sa conception bénéficie notamment du retour d'expérience d'exploitation de l'atelier de Cadarache.

French experience in the fabrication of plutonium-based nuclear fuels is considerable. As early as the sixties, the first fuels for the French fast breeder reactor (Rapsodie) were produced in the plutonium technology workshop, called ATPu and located at the CEA research centre at Cadarache. Since then, fuel has been fabricated for the Phenix, Superphenix, PEC (Italy) and PFR (GB) fast breeder reactors. This has involved the processing of more than twenty five tonnes of plutonium. In 1988, a MOX fuel fabrication line for pressurized water reactors was set up; this has the capacity of fifteen tonnes of heavy metal per year.

As the production capacity of this installation was insufficient to meet French demand for MOX fuel, the decision was taken to build a new plant. This plant, which has a design capacity of 115 tonnes of mixed plutonium and uranium oxide fuel per year, is in the process of being built at the Marcoule site.

After rapidly reviewing the experience feedback from the Cadarache workshop, the safety principles adopted in the design of this new plant, named MELOX, are described.

#### **1. ATPu operating experience**

ATPu is part of the Cadarache fuel fabrication complex (CFCa), which also includes a fabrication reject reprocessing unit for the recycling and the packaging of wastes.

This workshop, which was built some thirty years ago, was initially a fast breeder reactor fuel research laboratory. It was subsequently converted for the production of fuels for power reactors, such as Phenix and Superphenix. Numerous improvements were therefore made to attain a safety level corresponding to its function. For example, when extensions were built, the facilities containing plutonium powders were made into fire and containment zones. These zones were then equipped with a carbon dioxide extinguishing system to offset some weaknesses with respect to the design principles currently applied to such facilities. Similarly, the earthquake resistance of the installation was increased when the extensions were made. In view of the methods currently used to allow for the seismic risk, further studies are in progress for hardening the sensitive areas. Thus, this workshop of early design has benefited, with the passage of time and the upgrading of its capacity, from refurbishing which has, in particular, made it possible to improve the containment provided by the building and the allowance for internal hazards, particularly fire, so as to guarantee protection of the environment.

As concerns the protection of staff, containment of the material is ensured by glove boxes. To ensure the detection of any loss of containment as early as possible, (there being 5000 gloves in ATPu), detection devices are placed near the chambers (glove boxes). Similarly, devices for checking the undergloves used by the staff are placed near the chambers to ensure early detection of any loss of leaktightness of a glove. It is noteworthy that, of the whole radiological protection alarms which occur annually, 10% result from changing of gloves or transfer bags, while 60% result from perforation of gloves, despite the research carried out to obtain more resistant gloves. Furthermore, to reduce the risks of the spread of radioactivity during removal from chambers, the use of fixed connecting devices between the containments has been made general, as the process equipment refurbishing has been carried out.

The latter provision is also justified in terms of staff radiation exposure limitation. Indeed, the change of the quality of the plutonium handled, now originating from pressurized water reactor fuel reprocessing, in which the amounts of isotopes 238 and 241 and the neutron radiation are considerably higher than in gas-cooled reactor fuel, have led to the reinforcement of protection against external exposure to ionizing radiation. The gloveboxes were therefore protected with additional shielding on their walls, for example lead glass for protection against gamma and X-rays. Similarly, polyethylene, boron compounds or concrete containing boron was placed around the storage facilities for protection against neutron radiation. Lead oxide is also used in the fabrication

of the gloves, aprons, windows and protective glasses. In view of the nature of the material used, the internal cleanness of the chambers is also extremely important (limitation of retention). At the present time (as shown by the 1992 evaluation); records show that some 7% of the staff receive an annual dose of more than 20 mSv. Whatever the case, a decisive improvement in this field necessitates remote manipulation and a high degree of process automation. It is this requirement which is underlying the refurbishing currently being carried out in ATPu, for example the equipment for receiving materials, unloading and entry into the process circuit. However, as the workshop was not initially designed accordingly, improvements of this type can only be integrated as process modifications are introduced. Furthermore, it is clear that a future reduction in radiation exposure will require allowance being made in the design of the equipment for subsequent work on it, particularly for maintenance.

From the beginning of 1992, an important program is in progress in view to adapt the installation to MOX fuel fabrication, becoming the main CFCA activity. This program concerns at present the elimination of all unemployed irradiating material. It should aim to considerable diminution of the staff integrated doses.

To conclude, concerning the feedback of experience from ATPu, it is significant that this workshop has never been the scene of an accident which has affected the environment. Only local contamination incidents have occurred, essentially on removal of materials or equipment from gloveboxes. These incidents have had no major consequences for the health of the staff. The results are thus extremely positive, but nevertheless they highlight the importance of equipment containment quality and the arrangements to be implemented to minimize the exposure to ionizing radiation.

## **2. MELOX plant safety principles**

Construction of the MELOX plant for the fabrication of plutonium-based fuels for pressurized water reactors was authorized by ministerial decree on 21st May 1990, the licensee being Cogema.

The maximum annual output of the plant will be 115 tonnes of mixed uranium and plutonium oxide fuel, and the maximum quantity of plutonium oxide present must never exceed 14 tonnes. The plutonium handled must not contain more than 3% of americium 241 by weight. And the plutonium 240 content must be at least 17%.

The plant is now under construction and is planned to be commissioned in 1994.

It consists of the following three units :

- a fuel assembly fabrication building, providing the functions of reception of basic materials, fabrication of fuel rods, building of assemblies, checking of fabrication and acceptance testing,
- a building devoted to rejects and waste, including an incinerator for technological waste containing alpha particle emitters and providing the rejects and waste conditioning before expedition to the La Hague COGEMA plant, for plutonium recovery, or to a final storage centre,
- a number of ancillary buildings, providing functions such as the supply of electrical power, the staff access and the safeguard system operation.

The fabrication process adopted is derived from those which have been in use over the last fifteen years in the Belgonucléaire (Dessel, Belgium) and Cogema (ATPu) plants. It is very similar to that used to produce uranium oxide based fuel for pressurized water reactors. In particular, the mixed oxide pellets are produced by mixing uranium and plutonium oxide powder, the mix initially having a high plutonium content of between 25 and 30% (mother mix), which is then diluted with uranium oxide to obtain the desired proportion (between 3 and 11%).

The products used in the plant are uranium dioxide powder derived from natural uranium, which is normally depleted, or uranium obtained by the reprocessing of spent fuel, plutonium dioxide powder and different structural materials (fuel assembly frames and cladding).

The design objectives of the plant were the following:

- making allowance for feedback of operating experience from similar installations, such as ATPu,
- compliance with current safety criteria,
- maximizing recovery of plutonium from the technological waste produced by the plant, particularly by the use of an incinerator. Similarly, fabrication rejects are required to be processed in other suitable installations to recycle the plutonium and uranium contained in them.

These goals led to the laying down of the following safety principles.

## 2.1 - Nuclear hazards -

First of all, the bracketing properties of the nuclear materials used must be determined and used as the basic assumptions to establish the design basis with regard to the nuclear hazards. These characteristics essentially relate to the proportions of fissile isotopes and plutonium 240 concerning the criticality hazard and the proportions of uranium 232, plutonium 236, 238 and 241, americium 241 and residual fission products concerning the other components of these hazards.

It was therefore decided to use as a design basis spent light water reactor fuel with a burn-up of 33,000 MWd/t cooled for 6 years, and make additional studies for fuel with a burn-up of 45,000 MWd/t cooled for 2 years. To this, the following limits were added :

- a maximum americium 241 content of 3% by weight (this limit is reached either for a spent fuel with a burn-up of 33,000 MWd/t cooled for 6 years or for a spent fuel with a burn-up of 45,000 MWd/t and cooled 5.8 years),
- a fission product content (mainly Ru 106 and Rh 106) of 37,000 Bq/g of plutonium for 90 % of batches and 296,000 Bq/g of Pu for 10 % of batches,
- for thermal studies, an "envelope" spent fuel leading to a specific power of 19.9 W/kg of plutonium,
- for criticality studies, a maximum uranium 235 content of 1.2%, the reference plutonium composition being of 71% of plutonium 239, 17% of plutonium 240, 11% of plutonium 241 and 1% of plutonium 242.

### 2.1.1 Radioactive substance dispersion hazard

This hazard is addressed by placing physical barriers between the radioactive material and the staff and the environment, associated with a ventilation configuration ensuring a suitable negative pressure in the facilities.

Thus, static containment is provided by three barriers between the material and the environment. For powders, these are the containers or chambers of the glovebox type, the process or storage facilities and finally the building itself. The internal layout of the building is thus determined accordingly, separating the staff trafficways from the materials as much as possible. The containment chambers are quite big (several m<sup>3</sup> to several tens of m<sup>3</sup>) and are of leaktightness class 2 (leak rate between  $5 \times 10^{-4}$ /h or  $10^{-3}$ /h). In practice, the aim is to get a leak rate less than  $2.5 \times 10^{-3}$ /h). The containment chambers operating with powder or pellets are kept under nitrogen gas (case of grinding, mixing, granulation, pressing, sintering, aspect control gloves boxes). Furthermore, transfer between process and storage equipment is via fixed connections to minimize the loss of containment risk associated with such operations.

The dynamic containment provided by the ventilation system creates a series of pressure differentials ensuring a movement of air preventing the spread of radioactive substances from the parts of the installation with the highest risk of the dispersion towards those with the least. The rooms and equipments belong to containment classes (C1, C2, C3 and C4 classes) on the basis of the permanent and accident situation contamination level, for the purpose of assigning pressure differential levels and a number of filtration stages. The values of negative pressures and the number of filtration stages according to the classes are as follows :

containment class	Negative pressure in Pa	Number of absolute filter stages
C2 (corridors)	- 60 to - 100	1
C3(room with glove boxes)	- 120 to - 180	2
C4 (glove boxes)	- 400 to - 700	3

Four ventilation systems are provided :

- a very high negative pressure system for class C4 containment chambers (under nitrogen or under air),
- a high negative pressure system for the ventilation of class C3 rooms and cooling of storages,
- a mean negative pressure system for the class C2 rooms.

So, the air extracted from the rooms containing containment chambers passes through three filtration stages before release. In addition, arrangements are made to ensure that the ventilation is permanent, essentially by adequate redundancy of the electrical power supplies.

The overall objectives of these measures is to guarantee that contamination of the premises is zero during normal operation. An air radioactivity monitoring network and associated alarms ensure early detection of an abnormal situation.

#### 2.1.2 External ionizing radiation exposure hazard

The hazard is due to emissions of X-rays (Pu238, 240 and 242), gamma rays (Pu, Am241, U232, Tl208) and neutrons (spontaneous fissions and alpha particle/neutron reactions) from the materials handled.

During the plant design studies, the objective was set of limiting to as low as reasonably achievable the number of members of the staff liable to receive a full-body dose of more than 5 mSv per year under normal operating conditions. Protection against this hazard is based on:

- placing suitable shielding between the staff and the material, on the basis of workstation studies, associating protection as close as possible to the sources in the chambers with additional protection on the walls of the chambers,
- a high degree of automation or mechanization of the means of production to keep the operators distant from the sources of radiation. The equipment is thus monitored from rooms independent of the production rooms (transmission of information and video images). For example, the fuel manufacturing building includes 6 control rooms for the process),
- allowance, from the design stage, for the operation liable to be carried out on equipment to limit their number and duration (work zone accessibility and visibility constraints, standardization of equipment, design of mechanical equipment in the form of assemblies of replaceable modules, providing special means for carrying out work etc.).

All the operating staff are equipped with gamma and neutron dosimeters.

### 2.1.3 Criticality hazard

Study of this hazard is based on the reference composition of the radioactive materials and the plutonium contents of the mixes of powders mentioned earlier. The composition results in a significant margin as compared to standard MOX fuel.

The study is carried out using the principles laid down in the basic safety rule concerning the avoidance of the criticality hazard issued by the safety authorities. This rule specifically provides that:

- no single failure may be liable to result in a criticality accident,
- if an accident may result from two failures, it must be proved that the two events are totally independent, of sufficiently remote probability and that each can be detected within due time for taking action by a reliable monitoring system of a suitable nature.

Criticality and monitoring modes are determined for each part of the plant. These include:

- mass and moderation for the part where powders and sintered products are used, introducing the workstation concept,
- geometry for the storage of pellets and for the assembly and associated storage of rods and fuel assemblies,
- mass for the incinerator.

Thus, one or more limitations are imposed per workstation or item of process of equipment.

In addition, the plant is to be equipped with a criticality accident detection network.

### 2.1.4 Hazard associated with spontaneous heating

This hazard is allowed for in the storages of plutonium (mainly because of the plutonium 238 and americium 241 content).

They are protected against by a cooling ventilation.

### 2.1.5 Hazard associated with radiolysis

This hazard is very important in aqueous plutonium solutions, but it may also occur in the presence of organic compounds. The plant does not handle great quantities of plutonium solutions. This hazard is however to be considered for technological waste storages and fabrication rejects likely to contain added organic additives. Studies are in progress on this question.

## 2.2 - Non-nuclear hazards -

These are of two origins: internal to the installation, resulting from the products and processes utilized, or external, resulting from the nature of the site. Both can have nuclear consequences.

### *Hazards of internal origin*

#### 2.2.1 Fire and explosion hazard

This must be considered to be a major hazard for such an installation as it is liable to defeat the containment and cause releases to the environment.

Control of the fire hazard depends on the suitability of the arrangements taken to minimize the risk, to detect the outbreak of a fire and to mitigate the consequences. Thus, an effort is first made to reduce the fire load densities of the facilities and to utilize materials with favourable fire reaction and fire propagation properties. Thus, electric cables are of C1 type, avoiding the fire propagation.

The facilities are of course monitored by an automatic fire detection system triggering an alarm in a surveillance post where there is an emergency team. In view of the restrictions imposed by the criticality hazard, action can be taken using low hydrogen content extinguishing powders, carbon dioxide or Halon. It must also be pointed out that the presence of an inert atmosphere (nitrogen) in the process chambers constitutes a positive factor as regards the fire hazard.

- In the rooms containing significant amounts of fissile material in glove boxes or with a high fire load density, a CO<sub>2</sub> fixed extinguishing system has been installed. This is the case for rooms intended to milling, mixing, granulation, pressing, sintering, grinding and sorting rooms. This system includes two storerooms containing 2,000 kg of CO<sub>2</sub>, located inside the building.

- Lastly, it has been set up an additional extinguishing system, which can be supplied from outside the building. This system is connected above the nozzles of the fixed system.

Notwithstanding, allowance for the hazard in the design of the installation is essentially reflected in the way of the facility rooms are arranged, particularly those where powders are handled, to form fire and containment zones. A fire is thus maintained within the corresponding fire and containment zone, as well as the associated radioactive dispersion. In the MELOX plant, these zones are capable of containing an internal fire for at least two hours. This time is compatible with the present fire load density. A fire and containment zone is entered via ventilated airlocks with very high efficiency filtration at the ventilation inlets (air supply) and outlets (air exhaust), to counter radioactive dispersion, as well as fire doors and fire dampers in the ventilation ducts (normally associated with special treatment of all wall penetrations), for fire zoning. In addition, the control of the ventilation system in the event of fire can be pre-determined, by means of automatic reactions (shutting down the air supply) and manual.

Finally, to maintain extraction of the air from the zone affected by the fire for as long as possible, the plant extraction network is arranged to ensure dilution of the hot air extracted so as to protect the last very high efficiency filtration level before release to the environment (the dilution factor is between 8 and 10 according to the system). It is thus accepted that the very high efficiency filtration of the air will be lost at the point where it leaves the zone, in order to provide smoke-venting and to maintain a negative pressure in the room.

In addition, the temperature strength of the extraction ducts of the high negative pressure system is justified by calculation up to 200 °C temperature, between the room to the plenum.

A fire jeopardizing the integrity of a fire and containment zone is taken as a design basis accident for the plant to demonstrate the validity of the choices made.

As regards the internal explosion hazard, associated with the use of hydrogen in the sintering furnaces, the use of a mixture of argon with 5 to 10% of hydrogen is postulated, the mixture being made outside, and the presence of gas detectors in the facilities where the hazard is present and the ventilation conditions allowing dilution in the event of leakage.

### **2.2.2 Loss of power supply. Safeguard supply**

In addition to the normal power supply, the MELOX plant has at its disposal :



- one distribution train, supplied by a diesel generator, ensuring the standby power supply of the equipments related to the safety and operability of the plant,
- two redundant and independent safeguard trains, supplied by two diesel generators "A and B" to guarantee that :
  - the negative pressures of C3 class rooms and C4 class containment chambers are maintained (high and very high negative pressure systems are operating continuously),
  - certain plutonium storages (assemblies, PuO<sub>2</sub> containers, rods) are cooled.

### **2.2.3 Other hazards**

The other internal hazards (chemistry, electrical etc.) are circumscribed by rules corresponding to general labour regulations.

#### *Hazards of external origins*

### **2.2.4 Seismic hazards**

The Safe Shutdown Earthquake (SSE) adopted for the site is of an intensity of VIII-IX on the MKS scale, with two resonance spectra:

- one type-1 spectrum (shallow earthquake) set at 0.3 g,
- one type-2 spectrum (deep earthquake) set at 0.2 g.

These spectra are used as the design basis for the items of the installation important for safety (containment concerning environment and prevention of criticality hazard). The principles selected for the design basis of the equipments consist in :

- ensuring the ventilation of the C3 class rooms further to an earthquake (the high negative pressure system is thus calculated accordingly),
- ensuring the subcriticality conditions for the equipments containing Pu,
- ensuring the safeguard power supply (A and B trains).

### **2.2.5 Risk of flooding**

The risk results from the presence of a large river: the Rhône. The flood level of this river allowed for is the once-in-a-thousand-year level plus 15%, i.e. 37.5 m NGF.

In actual fact, the buildings are on a platform graded at 40 m NGF.

### **2.2.6 External explosion hazard**

This risk results from river transport on the Rhône. The maximum plausible accident is the explosion of a barge for the transport of hydrocarbons with empty tanks inadequately ventilated.

The resulting pressure wave, of around 45 mbar, is allowed for in the design basis of the civil engineering structures.

### **2.2.7 Aircraft crash hazard**

As concerns the aircraft crash hazard, the regulatory objective adopted is that the design of a workshop be such that the global probability of it causing unacceptable damage to the environment does not exceed  $10^{-6}$  per year.

As for MELOX the calculated probability of a military or commercial aircraft crash is sufficiently remote, the only allowance made in the design is for the local impact of an aircraft of the Cessna 210 type on the fuel fabrication building.

Finally, as concerns waste management, the option taken up consists of minimizing the quantities of plutonium leaving in waste. This essentially involves the construction of an incinerator for the technological waste containing alpha emitters and the recovery of the plutonium contained in the ash. The incineration process is the direct calcination : burning with air excess, post-burning in a SiC chamber, three filtration stages, gas washing.

In conclusion, the above-mentioned safety principles and the acceptability of the consequences of the accident situations likely to affect the installation (essentially fire in a room where plutonium powders are handled) have resulted in a French government authorization for the construction of the installation.

To date, apart from waste building which is under construction, all the buildings are constructed, the equipments are under installation or even being tested.

Another safety assessment will be necessary before commissioning, based on the proof that these principles have been allowed for in the construction of the installation, demonstration operating safety, tests results and implementation of the above-mentioned waste management policy. This assessment is expected early in 1994 and commissioning is planned in october of 1994.

BNS / OECD - NEA Symposium on the  
SAFETY OF THE NUCLEAR FUEL CYCLE  
BRUSSELS, 3 - 4 June 1993

**SAFETY RECORD OF THE GERMAN FUEL FABRICATION  
FACILITIES**

Wolfgang Thomas  
Gesellschaft für Anlagen- und Reaktorsicherheit (GRS) mbH  
(Germany)

Abstract

More than twenty years of uranium oxide and uranium-plutonium mixed oxide (MOX) fuel element fabrication in Germany show a remarkably good safety performance. Mean individual doses are less than 10 % of the annual limit. Also the collective doses are moderate. A higher degree of automation and improvements of shielding against neutrons are desirable for industrial scale MOX fuel fabrication. An overview of experienced discharges and relevant incidents is presented.

Resumé

Plus de vingt ans de fabrication des combustibles à uranium oxyde et à oxyde mixte (MOX) en Allemagne montre une remarquable bonne performance de sécurité. Les doses individuelles ont été moins de 10 pour cent de la limite annuelle. Aussi les doses collectives ont restées moderates. Concernant une fabrication MOX industrielle plus de automation et une amélioration de la protection contre la radiation neutronique sont recommandées. L'expérience des effluents et des incidents rélévantes est présentée.

## 1. Nuclear Fuel Fabrication in Germany

Manufacturing of nuclear fuel elements started in Germany with the operation of the NUKEM facility at Hanau in 1962. Basic chemical conversion processes and mechanical techniques were developed and implemented for a great variety of nuclear fuel elements: metallic high-enriched fuel elements for research reactors, low enriched uranium oxide fuel for LWR and high temperature reactor fuel elements based on thorium and uranium of high or intermediate enrichment. In 1969 a large-scale fabrication facility for LWR uranium oxide fuel went in operation with a chemical conversion capacity of nearly 900 t U/a. This plant formerly named as RBU, now operated by SIEMENS uses the AUC wet conversion process for  $UO_2$  powder production. Including two production sites at Hanau and Karlstein the SIEMENS Brennelemente-Werk has delivered the main share of  $UO_2$  fuel elements for the German nuclear power program.

As a consequence of the abandonment of the HTR in Germany and the very small market for research reactor fuel elements NUKEM gave up nuclear fuel element fabrication in 1989. At Lingen, Lower Saxony, EXXON Nuclear installed a LWR- $UO_2$ -pellet and fuel element production with a capacity of 400 t/a. This facility started operation in 1979 and is now operated by Advanced Nuclear Fuel GmbH (ANF). It is planned to complete the facility by adding a dry conversion route and powder production line.

The manufacture of plutonium to mixed oxide fuel (MOX) began 1965 at Karlsruhe with a small production line. 1971 the production was transferred to Hanau, where a MOX fabrication facility with two production lines went into operation in 1972. This facility, the ALKEM, included a wet oxalate conversion process for the conversion of plutonium nitrate delivered by the Karlsruhe pilot reprocessing plant. The ALKEM-facility was designed to fabricate FBR- and LWR-MOX fuel elements. The capacity of this plant now operated by SIEMENS is approximately 25 - 35 t MOX/a for LWR-fuel elements depending on the type of fuel element and the batch size. A separate fissile material storage building has been added which houses the stores for  $PuO_2$ , MOX and Pu-solutions. This building is designed and constructed for protection against extreme external events including crash of a fast flying military aircraft.

A new MOX fabrication plant with a capacity of 120 t MOX/a is presently under construction adjacent to these existing facilities /1/. This plant is designed for MOX fuel production by the OCOM-process starting from a mechanical mixing of master blend with approximately 30 % plutonium content. In a second blending step the desired LWR-MOX-plutonium content of 4 - 6 % is reached. This new production building also designed to withstand airplane crash has been erected. Presently the installation of the gloveboxes holding the technical equipment is under way. Construction and operation licence for the whole new plant has been issued in 1991, but presently only small progress is achieved due to difficulties with the authorities in Hesse after the social-democratic-green coalition came into office. The new facility is limited to a licensed inventory of 2 500 kg of Pu. The existing ALKEM production facility is intended to be used in the future only for waste treatment and uranium processing with a limiting value of 1 kg Pu. Table 1 gives an overview of the currently existing fuel manufacturing facilities in Germany.

Table 1: Nuclear Fuel Fabrication Facilities in Germany

Facility, Site	Start of operation	Product	Capacity
SIEMENS AG, Hanau UO <sub>2</sub> -Production	1969	UO <sub>2</sub> -fuel elements for LWR	900 t/a (conversion) 720 t/a (pellets)
SIEMENS AG, Karlstein UO <sub>2</sub> -Production	1966	UO <sub>2</sub> , Gd-Oxide	
ANF, Lingen	1979	LWR-UO <sub>2</sub> fuel elements	400 t/a
SIEMENS AG, Hanau MOX-Production	1972	MOX-fuel elements	25-30 t/a
New facility		MOX-fuel elements (LWR)	120 t/a

## 2. Safety Requirements

Nuclear fuel production facilities have to be licensed according to § 7 of the Atomic Energy Act of 1976 principally in the same way as a nuclear power reactor. The radiological safety criteria are based on the ICRP-recommendations and the EURATOM-directives. The main radiation dose limits in Germany as laid down in the Radiation Protection Ordinance of 1989 are listed in Table 2 /2/.

Table 2: Main Annual Radiation Dose Limits

	Annual Radiation Dose Limit, mSv/a			
	Employees 18 or over	Direct Radiation	Population Aerial Discharges	Liquid Discharges
Whole body effective dose	50	1.5	0.3	0.3
Individual organs and tissues, lens of the eye	150		0.9	0.9
Thyroid	150		0.9	0.9
Bone Surface, Skin	300		1.8	1.8
Hands, Arms Feet	500			

Notes:

- (1) For employees a total whole body lifetime dose of 400 mSv has not to be exceeded.
- (2) The limit of whole body effective dose for direct radiation includes contribution from discharges.

For MOX fuel fabrication the annual limits of intake for plutonium and americium are of great importance. Our Radiation Protection Ordinance requires an inhalation annual intake limit for Pu or Am of 100 Bq. For plutonium in form of PuO<sub>2</sub> the limit is 400 Bq.

The licensing procedure for fuel cycle facilities follows a deterministic approach. Technical safety criteria for uranium and plutonium fuel fabrication have been established including definitions of design basis accidents /3, 4, 5/. For these events a dose limit of 50 mSv effective whole body dose outside the facility shall not be exceeded. Extremely rare events exceeding the design basis accidents regime are taken into account in proportion to risk reduction. Process and storage buildings containing considerable amounts of plutonium therefore have to be designed and built to resist earthquake, pressure waves from external chemical explosions and airplane crash from a military aircraft.

### 3. Occupational Exposure

Uranium fuel element fabrication:

The following tables show the collective doses and the mean annual individual doses from UO<sub>2</sub> fuel element production at the SIEMENS uranium production at Hanau. There is no specific trend observable, the collective doses typically sum up to 1 - 2 man-Sv/a. The mean annual individual doses are 1 - 3 mSv/a. The contribution of effective dose due to incorporation is significant and has to be added to the measured external radiation exposure.

Table 3: SIEMENS UO<sub>2</sub>-Fuel Fabrication, Annual Collective Doses

	Collective Doses, man-Sv			
	1989	1990	1991	1992
Effective Dose	0.568	1.503	0.901	0.720
Effective Dose from Incorporation	0.618	0.840	0.293	0.168
Additional Incorporation from abnormal Operation	0.348	0.310	0.148	0.229

Table 4: SIEMENS UO<sub>2</sub>-Fuel Fabrication, Average Annual Individual Dose

	Individual Dose, mSv			
	1989	1990	1991	1992
Effective Dose	1.17	1.78	0.90	0.81
Effective Dose from Incorporation	1.07	1.00	0.33	0.19

Occupational exposures at the ANF fuel assembly production are very small. The collective dose typically is below 0,1 man-Sv/a, the mean individual doses are between 0.5 and 1 mSv/a.

**MOX fuel production:**

The integral MOX fuel production between 1969 and 1992 amounts to 26 000 fuel rods for FBR holding 5.8 t heavy metal with 1.4 t of Pu-fiss and to 80 000 fuel rods for LWR corresponding to 158 t heavy metal with 4.5 t of Pu-fiss. Fig. 1 shows the annual fuel rod production for 1980 - 1992. In July 1991 a contamination incident occurred. Due to interdiction by the State authority production was prohibited and only resumed for a short period in 1992 to finish two fuel elements from the already fabricated master blend. Therefore the occupational doses in 1991 and 1992 are not representative. Occupational doses at the SIEMENS MOX fabrication are shown as collective and mean annual individual doses in the following figures 2 and 3.

**Figure 1: SIEMENS MOX-Fabrication, Number of Fabricated Fuel Rods 1980 - 1992**

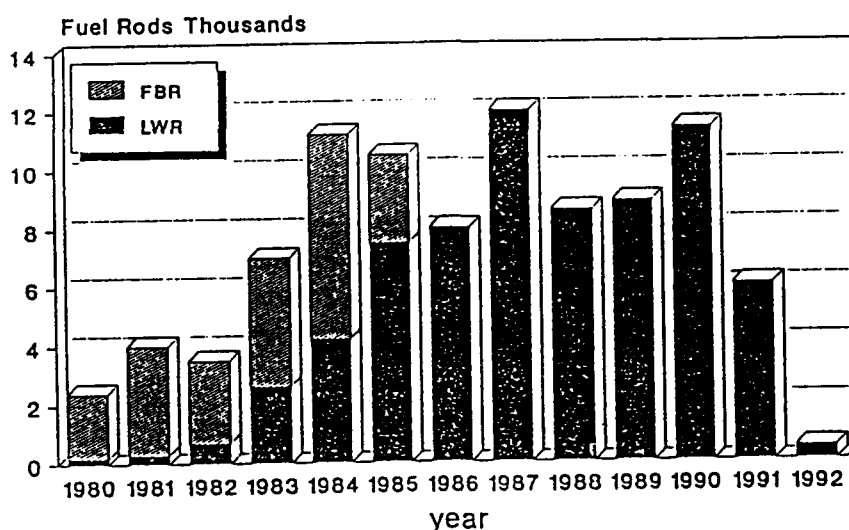

**Figure 2: SIEMENS-MOX-Fabrication, Annual Collective Dose**

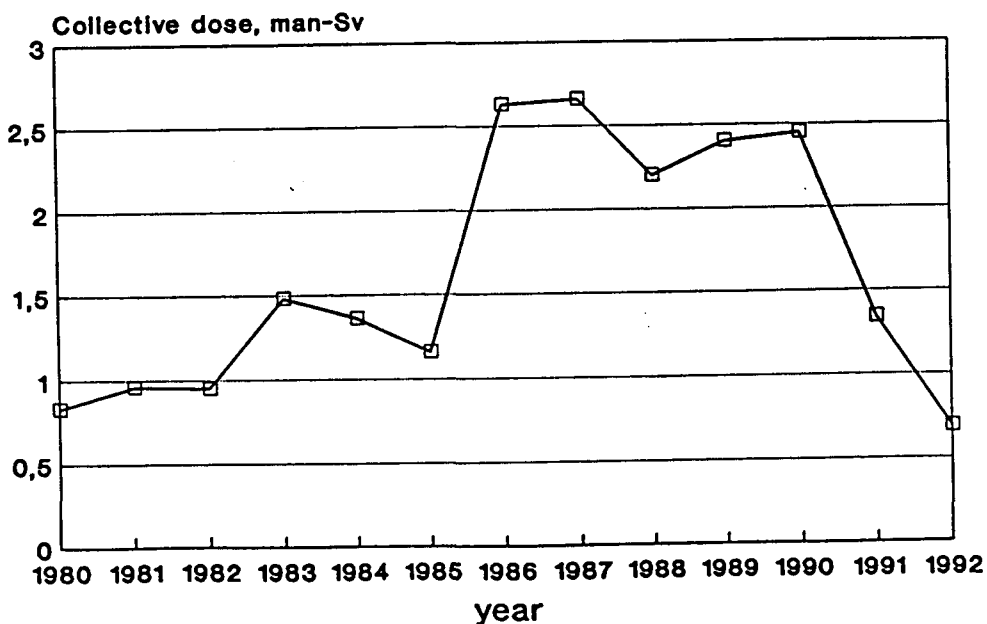
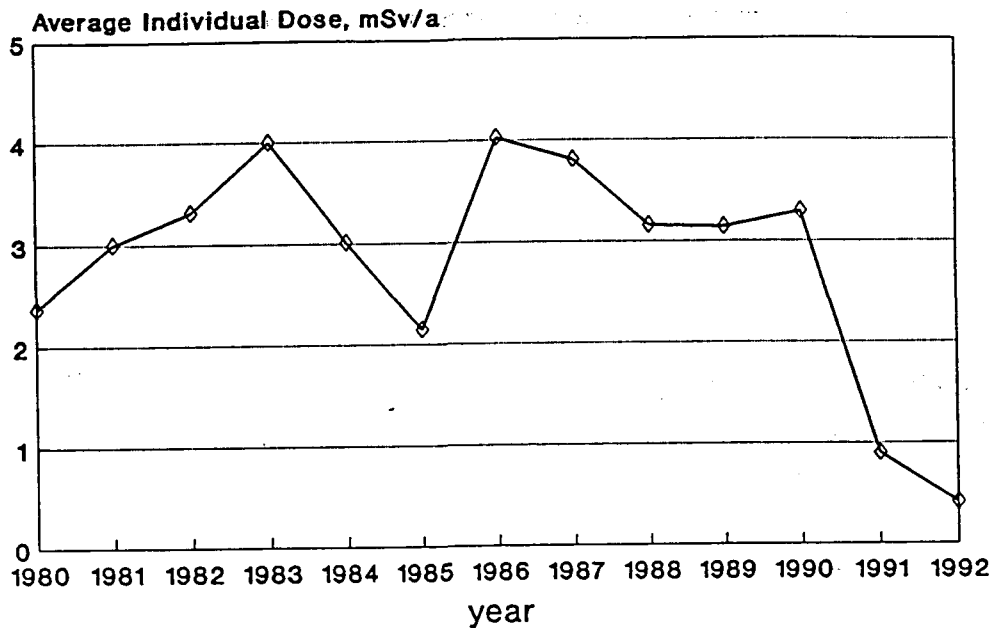

Figure 3: SIEMENS MOX-Fabrication, Average Annual Individual Dose



The increase of the collective dose from 1985 to 1986 mainly can be contributed to the increase of plant personnel engaged for the expanded LWR-MOX production. To a smaller extent the change of plutonium isotopic composition with increased radiation source strength may be relevant. Also since that time the neutron dose is included in the dose ratings.

Fig. 4 gives a distinction of the exposures of plant personnel and contracted persons.

Figure 4: SIEMENS MOX-Fabrication, Annual Collective Dose for Plant Personnel and Contractors

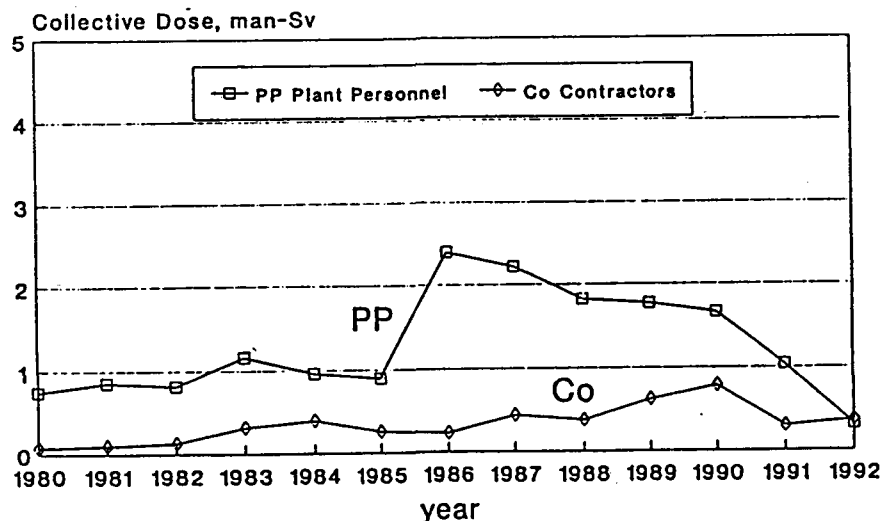

Whereas the mean values of individual doses in MOX fuel production typically are 3 - 4 mSv/a and far below present limits (50 mSv) and the recommended new ICRP-limit (20 mSv), there is a considerable variation of exposure for different workplaces and activities (Table 5). For a large-scale fabrication of MOX with increased neutron source strength improved shielding, remote handling and automation have to be foreseen especially for powder-pellet production and plutonium stores.



Table 5: Dose Contributions from Typical Activities (Three years average, 1988 - 91)

Activity	Collective Dose mSv/a	Average Individual Dose, mSv/a
Storage of fissile material	48	5.7
Powder-pellet production	877	9.7
Fabrication of rods, assemblies	119	3.8
Analytic laboratories	170	3.2
Chemical processing, waste treatment	208	3.1
Maintenance	196	1.6

#### 4. Discharges

Uranium fuel fabrication:

Aerial discharges of alpha activity from SIEMENS uranium fuel production range typically between 20 and 50 MBq/a (Authorized limit 250 MBq/a). Compared to the discharges of the seventies a reduction by a factor of 5 - 10 has been achieved. A similar trend can be observed for the liquid discharges (Fig. 5).

Figure 5: SIEMENS UO<sub>2</sub>-Fabrication, Liquid Discharges

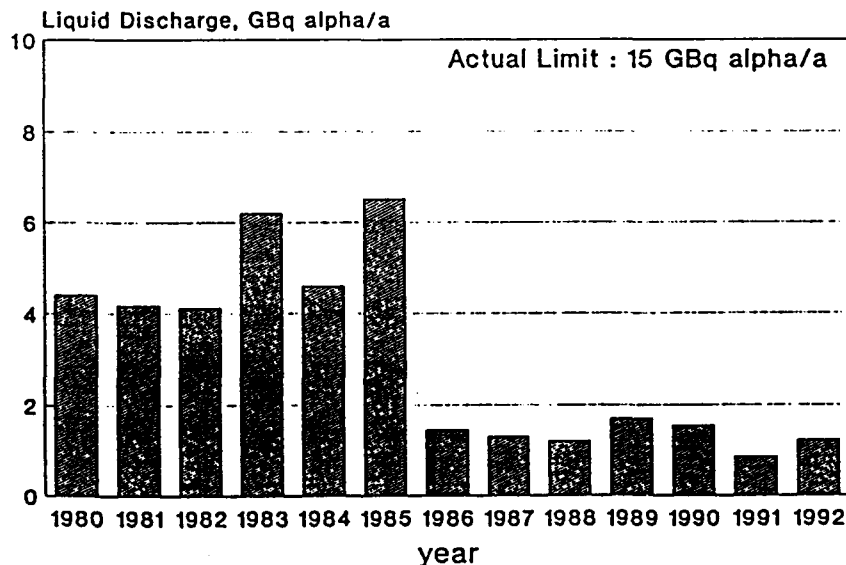

MOX fuel fabrication:

MOX fuel fabrication facilities are equipped with multiple stages of HEPA filters. Therefore aerial discharges of alpha activity are very low (less than 0.1 MBq/a). Liquids with alpha contamination generally are not discharged, but mainly added to cementation of solid waste. Only waste water with a contamination below 0.67 kBq/m<sup>3</sup> can be discharged. Total annual release of alpha activity is about 1 - 3 MBq/a.

## 5. Incidents

According to a Federal Ordinance unusual events and incidents have to be notified to the State authorities. These notifications are collected and carefully investigated for possible improvements by backflow of experience. The total number of these notifications is not very relevant since most events had no or only minor safety significance.

In uranium fuel production four incidents should be mentioned due to their safety relevance and the lessons to be learnt.

- In 1980 the RBU-1-plant was in operation for three days without any filtration of uranium dust in the off-gas ventilation. A simultaneous break of two filter banks remained undetected. The monthly discharge limit for alpha activity was exceeded.
- In 1987 a large  $UF_6$ -release occurred during maintenance work at the autoclaves. 50 kg of  $UF_6$  were released within the conversion plant causing intensive decontamination work. The personnel and the environment were not affected. Technical improvements have been installed at the autoclaves to prevent these releases.
- In 1990 an off-gas scrubber exploded due to chemical reaction of accumulated ammonium nitrate and nitrite. The explosion of the slurry was initiated by a hot-running loop pump. Considerable damage resulted to the installations of the scrap recovery section of the SIEMENS conversion plant. A description of this incident is given in /6/.
- Scrap material from a research institute was dissolved at the NUKEM uranium scrap recovery facility in 1987. Due to insufficient declaration and control the plutonium content of the scrap material remained undetected. The facility was contaminated by plutonium traces, 68 persons got small plutonium incorporations with a maximum dose of 110 mSv. This event shows the importance of a strict separation of uranium and plutonium scrap material treatment and also the need for fissile material control for MOX fuel production.

Contrary to the public opinion the experience with German MOX fuel production over 20 years demonstrates a high safety standard with only minor incidents. No major accident occurred as anticipated as design basis accident in the licensing procedure like criticality, explosion or fire. Typical incidents which took place repeatedly were:

- Plutonium incorporations due to defective gloves or during handling incidents
- Wound contaminations during maintenance and repair
- Small contaminations at waste treatment or due to leakages.

Only in two cases since 1980 the annual limit of intake for plutonium was slightly exceeded.

## 6. Conclusion

Experience over more than 20 years with uranium and plutonium fuel element fabrication in Germany shows a remarkably good safety record. Occupational doses for  $\text{UO}_2$ - and MOX fuel fabrication are comparable. The mean individual doses are 2 - 4 mSv/a and far below the annual dose limits. Nevertheless improvements of better shielding, remote handling and automation are desirable for industrial scale MOX fuel fabrication. Discharges from fuel manufacturing generally are small and have only minor radiological impact. Important lessons to be learnt from incidents are improvements to prevent  $\text{UF}_6$ -releases esp. during repair at autoclaves, a strict control of scrap recovery activities, separation of uranium and plutonium fissile material and the prevention of accumulation of ammonium nitrate or nitrite. The glove-box technique for MOX production should be improved to automation. Activities using the gloves should be restricted only to process control, quality assurance and non-routine operations.

## 7. References

1. J. Krellmann, "Plutonium Processing at the SIEMENS Hanau Fuel Fabrication Plant", Nuclear Technology, vol. 102 p. 18 (April 1993)
2. Strahlenschutzverordnung vom 30. Juni 1989
3. Bundesminister des Innern: Sicherheitsanforderungen für Kernbrennstoffversorgungsanlagen. RS-AGK-5-510321/2 (Juni 1983)
4. Sicherheitsanforderungen für die Herstellung von LWR-Brennelementen mit niedrig angereichertem Uran. GRS-A-1460 (Dezember 1991)
5. Sicherheitsanforderungen für die Herstellung von Uran / Plutonium-Mischoxid-Brennelementen. GRS-A-1462 (Dezember 1991)
6. OECD-NEA, "The Safety of the Nuclear Fuel Cycle, 1993



**BNS/OECD-NEA Symposium on the  
SAFETY OF THE NUCLEAR FUEL CYCLE  
BRUSSELS, 3-4 June 1993**

**Present Status of the Hanau MOX Fuel Fabrication Facility  
with Emphasis on Safety Issues**

**G. Brähler  
SIEMENS AG, KWU  
Fuel Fabrication Facility, Hanau, Germany**

**Abstract:**

Layout and design principles of both the MOX plants in the fuel fabrication facility in Hanau are described. The experience in the production of more than 180 t of MOX fuel in the existing plant is presented, this is the basis for the erection of a new plant with an annual throughput of 120 t heavy metal. The main safety aspects (radiation protection, contamination control, safety against accidents, criticality safety) are presented. Thanks to the high degree of automation, a collective dose rate of under 1 Sv/y is expected, protective measures against accidents guarantee the safe observation of limit values.

Production in the existing plant as well as the erection of the new plant are being drastically obstructed by the authorities of the State of Hesse.

**Résumé:**

Le présent document décrit l'arrangement et les principes de conception des deux unités de fabrication du combustible MOX, à l'usine d'Hanau. On y présente l'expérience acquise à travers la fabrication de plus de 180 t de combustible MOX dans l'unité existante; cette expérience sert de base à la construction d'une nouvelle unité, dont le débit annuel sera de 120 t de métal lourd. Les principaux aspects relevant de la sûreté (radioprotection, contrôle de la contamination, sécurité vis-à-vis des accidents, sûreté-criticité) sont abordés. Grâce à un degré d'automatisation élevé, on escompte une dose collective inférieure à 1 Sv par an; les mesures de protection prises pour empêcher les accidents et limiter leur conséquences garantissent de manière certaine le respect des valeurs limites.

Les autorités du Land de Hesse entravent lourdement la production dans l'unité existante et la construction de la nouvelle unité.

The SIEMENS MOX fuel fabrication facility in Hanau (formerly ALKEM) actually consists of two parts:

- existing plant

- throughput 20 t HM - 25 t HM in thermal MOX/a
- the present production lines will be decommissioned when the plant under construction is put into operation

- plant under construction

- throughput 120 t HM in thermal MOX/a
- scheduled for operation with Pu in August 92, delayed by "law enforcement towards abandoning of nuclear power" by the government of the State of Hesse.

In the following the main characteristics and experience with regard to the two plants are presented.

### 1. Existing plant

The original purpose of ALKEM was - beside R + D-work - to convert Pu nitrate from the Reprocessing Facility Karlsruhe as well as PuO<sub>2</sub> from French reprocessing plants into fuel for the German fast breeders (KNK, SNR 300) .

At a rather early stage thermal Pu recycling became interesting, and actually the fabrication of thermal MOX from PuO<sub>2</sub> ex UP 1/2 is now the primary business operation.

#### 1.1 Fabrication Processes

The existing plant is characterized by the following fabrication processes:

- production of highly soluble MOX via the "Optimized Co-Milling" process (OCOM) from PuO<sub>2</sub> and UO<sub>2</sub> ex AUC. Alternatively MOX powder can be produced via the AU/PuC-Co-conversion process in a 150 kg Pu/a-plant from Pu nitrate (e.g. from scrap) (Fig. 1)
- TIG and resistance pressure welding for fuel rods
- assembling of PWR, BWR and FBR fuel assemblies

#### 1.2 Layout and Design Principles

##### Operational Safety

For the safe handling of Pu in a MOFFP the greatest care is paid to the protection of the working staff against chronic or accidental radiation exposure from external radiation fields or the intake of radioactive material, and to avoid dispersion and release of Pu-aerosols from the plant. To ensure this protection the following safety measures are applied:

- The plutonium and plutonium containing material is strictly confined inside airtight glove boxes, which are under constant underpressure.

- All glove boxes are located within additional zones also with tight barriers. The plant exhaust systems provide for a stepwise decrease of the air pressure in the direction of the areas with higher contamination risks. The atmosphere in all zones is exchanged 2 - 8 times an hour.
- There are separate ventilation systems for each glove-box-line and building. The exhausted air from the boxes and all working areas passes through several absolute filters connected in series before leaving the building. With these measures the amount of Pu which is released into the atmosphere with the ventilation air under normal operational conditions is negligible. In the SIEMENS plant the released Pu over the past few years did not reach 1 % of the maximum permissible value.
- The atmosphere inside the working rooms and all air streams of the plant are continuously monitored for contamination. In addition, to ensure early detection of radioactivity dispersion all equipment as well as hands, feet and clothing of each worker are permanently checked. No contamination is allowed outside the glove boxes.

With respect to external radiation the following items should be mentioned:

The production lines have been built up in such a way, that most of the process steps are mechanized, but manual working inside the glove boxes by the staff still necessary and external radiation was the main contribution to the radiation exposure of personal.

The radiation hazard depends on the isotopic composition of the plutonium. At the beginning of MOX-fabrication in the MOFFP in Hanau Pu from fuels with relatively low burn up was handled. Therefore different sorts of lead-shielding on the outside of the glove boxes, lead-containing gloves and windows - especially in the conversion and powder preparation area - was sufficient for adequate decrease of the gamma-radiation rate.

The radiation increased with higher burn up of the fuel. Particularly from the increasing contribution of neutron radiation, considerable dose problems arose. But these problems could be solved by developing special gel-filled shieldings, in the form of movable constructions.

Although increasing radiation source strength and increasing throughput all in all it could be ensured that the individual dose of the workers, with few exceptions, did not exceed 10 mSv/a. The mean dose of all exposed persons always lay in the region of 5 mSv/a.

However, considering the further increase of burn up, recycled Pu, the dose problems for hands and forearms during manual operations in glove boxes and the generally reduced radioprotection limits, shielding alone could not be the solution for a modern fabrication plant with high throughput. Therefore strict automatization of all routine fabrication processes was unavoidable.

But improvements like this could not be realised in the existing plant, because of licencing complications.

Keeping glove boxes clean - facilitated by the low dust generation of the processed MOX with  $UO_2$  ex AUC - is a very strong measure to reduce personel doserates.

Criticality safety is achieved by applying the principles of safe geometry, neutron poisoning, moderation control, and only in cases of non-standard handling by safe masses. The double fault principle is strict practice.

The criticality alarm system consist of a number of  $\gamma$ -detectors. The system alarms, if two detectors measure a  $\gamma$ -dose rate resulting from 5 E18 fissions.

### 1.3 Experience

The throughput, accumulated from 1966 to 1992, is as follows:

- Pu fissile: 5,817 kg total, 1,357 kg fast, 4,460 kg thermal
- Heavy metal: 163,862 kg total, 5,883 fast, 158,029 kg thermal

with a maximum of fast fuel in the years 81-85 and an increasing throughput of thermal MOX, e.g. from about 5 t/a in the 70's to more than 20 t/a in '87-90.

The Pu vector was changing at this time, with the following band-width [%]:

Pu 238	0.02 - 1.5	
Pu 239	50 - 91	
Pu 240	8 - 31	Am: 0 - 1
Pu 241	0.7 - 15	
Pu 242	0.07 - 7	

Especially the rising Pu 238 and Pu 241 values, due to the change from Magnox-Pu to high burn-up LWR-Pu, caused a strong increase in  $\gamma$ - and n-source strength.

Counter measures have been taken and are described above, as a result the collective annual effective doses could not only be kept at a low level, but even reduced by a factor of 0,7 between 1986 and 1990 ( $\gamma+n$ -Dosis). These values correspond to an annual throughput of 23 t MOX, respectively 850 kg Pu tot. Incorporation never significantly contributed to personnel doserates, a result of strict contamination control.

### 1.4 Status

On 17.6.91 an incident occurred:

In the central storage facility a contamination occurred, caused by a leak in the double foil covering of a can containing MOX powder. 5 persons incorporated activity, a yearly effective dose of 38  $\mu$ Sv resulted for the highest exposed person, this is 0,075 % of the maximum permitted value.

The whole plant was shut down by the green Hesse Ministry of Environment and despite the fact that an overpack was developed to avoid future damaging of foils, up to the present date restart has not been permitted.

In our opinion this is illegal practice.

The relevant courts will decide on the subject, a first decision was reached in April '93. It was in favour for Siemens.

The plant is emptied from Pu, operation could be restarted.



## 2. Plant under construction

In 1981 it was decided, to erect a new MOX plant in order to meet the changing requirements with regard to throughput, fuel burn-up and safety issues. The main guideline was to keep to the proven philosophy and basic techniques and to improve economics, quality assurance, radiation protection, safety and security.

### 2.1 Processes

In the new plant nearly the same production processes will be used as in the existing plant.

### 2.2 Layout and Design

The basic principles of

- contamination control with

- the three-barrier concept including special ventilation systems and exhaust air filtration, (Fig. 2)
- the separation of process and supply systems,
- intensive contamination monitoring,

- criticality safety with

- a Pu-Vektor 95% Pu 239, 5% Pu 240
- priority of technical measures instead of administrative ones
- double failure principle

are just the same as described above for the existing plant.

Dramatical improvements can be shown for

- radiation protection and
- safety against accidents.

This will be presented in the following chapters:

### 2.3 Radiation protection, Dose-Minimization

The calculation of personnel doses are based on the following isotopic composition (reference Pu vector):

Pu 238-242, %: 1.5/58.6/23.8/11.0/4.8/Am 241 0.3

This vector corresponds to a burn-up of 32 GWd/t.

For the plant design the radiological relevant source strength was set at 125 % compared to this reference, the Am-value to 1.75% (maximum permitted 3%).

The maximum value of the personnel effective dose for normal operation was set at 10 mSv/a.

This aim is reached with the aid of the following technical improvements:

- connection of all Pu-bearing systems from PuO<sub>2</sub> inlet to rod outlet, pneumatic powder transport (possible due to the excellent flowability of UO<sub>2</sub>-powder ex AUC) with a new developed pipe-transportation method for two-materials-mixtures; belt-transportation of pellets
- fully automated processes, sampling included (Fig. 3)
- operation control from central control rooms
- use of shielding within the glove boxes, combined n/γ-shieldings (PE+lead+neutron absorber) in steel claddings
- use of double walled glove boxes, filled with hydrogenous materials
- possibilities to empty systems for maintenance and repair

- minimization of contamination of glove boxes by the use of tightly sealed equipment
- use of shielded vehicles for transport of fuel rods and assemblies

The required 10 mSv/a will be well observed, and the collective dose will not exceed 1 Sv/a.

This value corresponds to an annual throughput of 120 t HM with a mean Pu-content of 7.2%.

## 2.4 Safety against accidents

The Radiation Protection Ordinance requires, to proof that the radiological consequences as a result of accidents for people living around a plant, are below certain levels, e.g. 50 mSv effective dose equivalent.

The following accidents are taken into account for the new MOX plant at Hanau:

- Internal events  
fire (local, fire in HEPA-filters), criticality ( $5 \times 10^{18}$  fissions) leakage (powder and solution), crash of Pu-bearing containers, failure of auxiliary systems, explosion
- External events  
earthquake, high tide, storm, lightning, external fire, pressure wave (external explosion) and airplane crash

Depending on the probability of occurrence, the events are handled in various ways:

- probability  $> 10^{-6}$  Design Basis Accidents:  
The radiological impact must be calculated, the exposure must be below the legal limits, and requirements of minimization must be fulfilled.
- probability  $< 10^{-6}$  Accidents:  
No calculation of radiological impact is necessary, but measures to reduce radiation exposure are required.

For the calculation of the radiological impact not only the above described isotopic composition of Pu is used, but a more conservative one was also calculated:

	Reference	Conservative
Pu-238	1.5 %	3.87 %
Pu-239	58.6 %	74.38 %
Pu-240	23.8 %	5.0 %
Pu-241	11.0 %	13.75 %
Pu-242	4.8 %	-
Am-241	0.3 %	3.0 %

The calculated radiological impact for the design basis accidents with possible Pu-release is as follows (effective dose equivalent, Sv):

Fire in HEPA filters	2.7 E-11
Criticality	3.9 E-3 (from Iodine)
Leakage	2.2 E-10
Crash of glove box	3.7 E-15
Earthquake	1.2 E-7

## 2.5 Special Aspects of Safety against Accidents

In the following some accidents of special interest and measures for avoiding and minimization of radiological impact are discussed in more detail.

### Earthquake

The basis for calculations is an earthquake with a strength of 6-7 on the MSK-scale. This leads to an horizontal acceleration of 2-2.45 m/sec<sup>2</sup> at frequencies between 3 and 10 s<sup>-1</sup>.

The measures to avoid/minimize emission of Pu are:

- the design of the buildings (steel concrete, two shells) (Fig. 4)
  - the glove boxes are stable, some of them (with high inventory) remain operable
  - no criticality can occur
  - a fire after earthquake is excluded by several measures, among them the automatic shutdown of the power supply and the interruption of the gas supply
  - to avoid spreading of contamination and to cool high Pu-inventory, an underpressure is kept in the corridors and in the storage rooms.
- An emergency exhaust air system with its own diesel generators will be used.

### Fire

Numerous measures are taken to avoid fire in the plant and to minimize consequences, among them:

- strict partitioning of the plant into fire zones, automatic separation of connections (pipes, ventilation systems) in case of fire
- automatic operation of extinguishing systems (sprinkler, gas), started by fire detectors
- fire detectors in glove boxes
- an own specially equipped fire brigade

### Aircraft Crash, Pressure Wave

The probability of an aircraft crash is well below 10<sup>-6</sup>, nevertheless the building is designed against this accident.

The 1.80 m - 2 m steel-concrete and the two shell structure are proof against penetration of a military jet.

The impact of a pressure wave (external explosion) is covered by the design against aircraft crash.

## 2.6 Radioactive Effluents

Finally, some data concerning radioactive effluents from normal operation of the plant (maximum permitted per year), the monitoring methods and the radiological impact on persons outside the plant are shown:

### Airborne effluents

- 5.55 E5 Bq  $\alpha$ -activity, aerosols
- 3.7 E12 Bq Rn 220
- continuous monitoring of exhaust air with ABPD-devices at different stages of the ventilation systems, continuous dust sampling from stack air
- 3.8 E-6 Sv, effective dose equivalent, 50 years integrated at the highest exposed point near the fence

**Liquid effluents.**

- 4.44 E7 Bq  $\alpha$ -activity
- continuous collection of all effluents in tanks, sampling, measurement and release by radiation protection staff; no decontamination of contaminated effluents, treated as radioactive waste
- 2.8 E-9 Sv, effective dose equivalent, 50 years integrated

**2.7 Status**

Start of production was scheduled for August 92, and until the beginning of 1991 construction work was on time.

However everything changed with the election in the Hesse State in January 1991, after which a social democrat/green government declared stopping the production of MOX fuel elements in Hanau as an aim as well as the shutdown of the nuclear power plant Biblis.

The authorities began what is called "law enforcement towards abandoning of nuclear power". The result: Today 90 % of the new plant is finished and the future will also depend on the result of "the energy consensus debate".

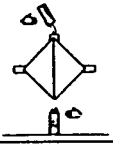
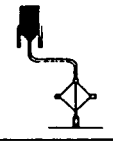
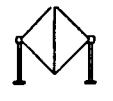
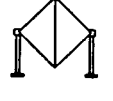
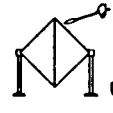
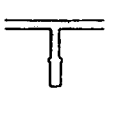
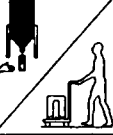
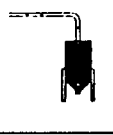
Existing Plant		New Plant	
Figure	Description	Figure	Description
	manual input of powders		pneumatic powder transport from intermediate storage or material entrance
	mixing operation		mixing operation
	manual sampling, manual transport of samples to the laboratory		automated sampling; transport of samples by pneumatic dispatch system
	manual filling in cans; partly removal from glove box system and transport to storage area		pneumatic powder transport to pressfeed storage

Comparison of Automation  
Example: mixing

Fig. 3

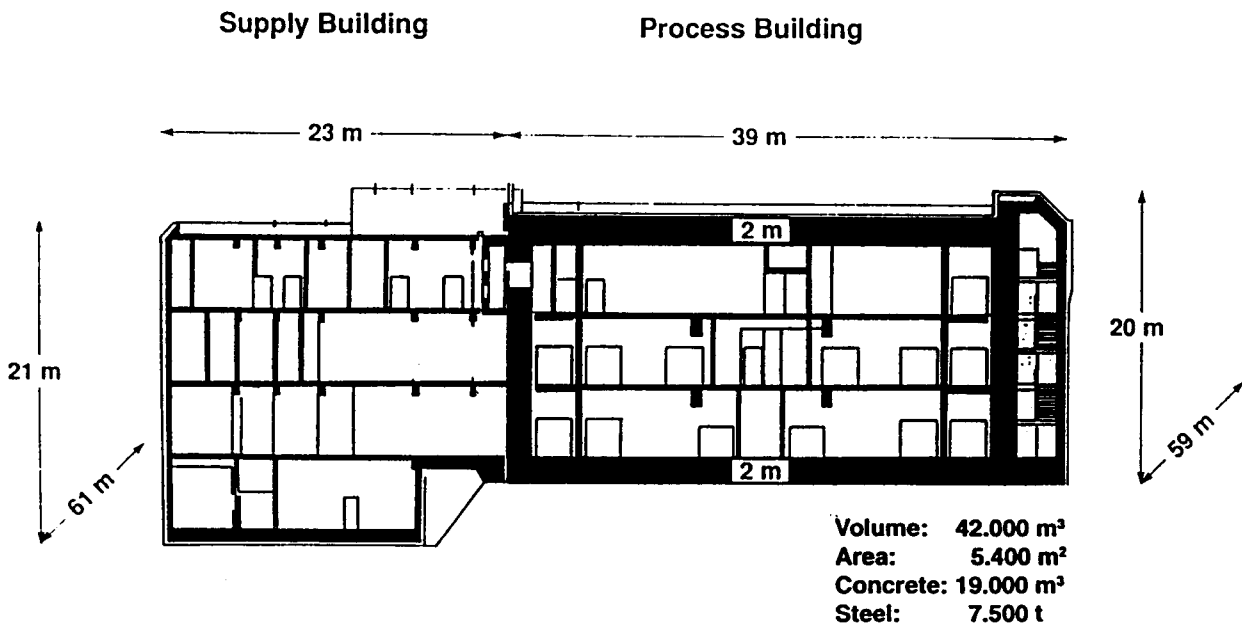

New Plant: Buildings

Fig. 4

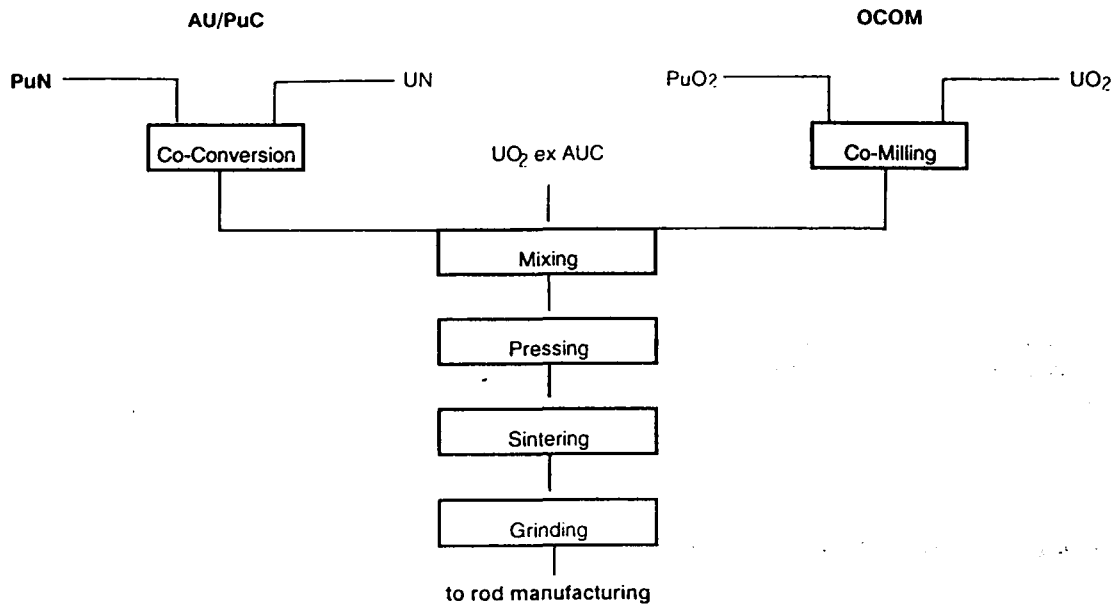

New Processes for Fabrication of Soluble MOX-Fuel

Fig. 1

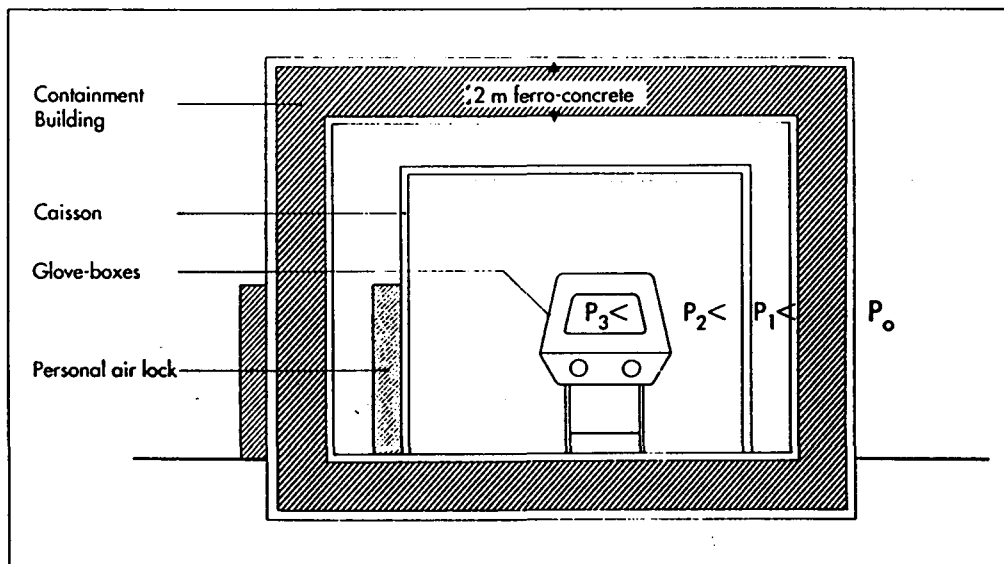

Barrier Concept for the Mixed Oxide Processing Plant with Graduated Decreases in Pressure

Fig. 2

**BNS/OECD-NEA Symposium on the  
SAFETY OF THE NUCLEAR FUEL CYCLE  
BRUSSELS, 3-4 June 1993**

**SAFETY RECORD OF THE FRENCH  
REPROCESSING PLANTS**

*J.P. Mercier*

*Département d'Evaluation de Sûreté,  
Institut de Protection et de Sûreté Nucléaire,  
Commissariat à l'Energie Atomique,  
Boîte Postale 6,  
92265 Fontenay-aux-Roses,  
FRANCE.*

**RESUME**

En France, le retour d'expérience est très important pour le dimensionnement, la surveillance et la conduite du procédé en vue d'une amélioration continue de la sûreté. Ce retour d'expérience représente une base essentielle, qui complète et conforte celle des règles nucléaires ou objectifs de sûreté déterministes et probabilistes pour l'évaluation de la sûreté des installations. La conception des nouvelles usines de traitement du combustible irradié (UP3-A et UP2-800) fait apparaître des améliorations notables de la sûreté.

**SUMMARY**

In France, feedback from experience is very important in the design, the surveillance and the control of the process, with a view to the continuous improvement of safety. This feedback represents a vital component, which adds to and enhances the nuclear rules and the deterministic and probabilistic safety objectives for the safety evaluation of the installations. The design of the new reprocessing plants (UP3-A and UP2-800) brought about considerable improvements in safety.

## 1. REPROCESSING PLANTS IN FRANCE.

Reprocessing of irradiated fuel is the key activity of the fuel cycle with uranium and plutonium recovery. It has been an industrial activity for more than thirty years in France : the first large reprocessing plant, UP1, started activity back in 1958 on the Marcoule site in the South of France. UP1 was originally designed to process fuel from plutonium producing reactors on the Marcoule site (reactor G1 followed by reactors G2 and G3). Since they were commissioned at the end of the fifties, all the facilities have been modified and extended to receive and process gas-cooled, graphite moderated reactor fuels and fuels from the fast breeder reactor Phenix. The first industrial vitrification facility for high activity waste was completed at Marcoule in 1978 ("Atelier de Vitrification de Marcoule" : AVM).

UP1 has reprocessed today more than 5000 tonnes of gas cooled reactor fuel and is continuing activity on French and Spanish fuels of this type.

Based on experience gained from the Marcoule plant, in the sixties, a second plant UP2 has been built at La Hague.

Plant UP3-A was commissioned by stages between 1989 and 1990. For at least 10 years, it will be devoted entirely to reprocess  $UO_2$  fuel assemblies belonging to foreign electricity companies.

Plants UP2 (400 tonnes per year) and UP3-A (800 tonnes per year) on the La Hague site have already reprocessed more than 5000 tonnes of gas-cooled reactor (GCR) fuel (up to 1987) and 4800 tonnes of fuel from light water reactors (LWR).

The extension of the existing plant UP2 (400 tonnes per year) to UP2-800 (800 tonnes per year in 1993) will be put into service at the end of 1993.

The fissile and non-fissile radioactive materials treated in such facilities undergo changes of their physical and chemical form by the application of different processes. The principal transformations consist of shearing of the spent fuel assemblies and dissolving them in nitric acid (facility T1), followed by removal by solvent of the uranium and plutonium from fission products (facility T2) and packaging of these materials (the uranium in facilities T3-T5 and the plutonium in facility T4).

The spent fuel reprocessing plants consist of a number of facilities in which the radioactive materials are subjected to specific treatments. The main potential risk associated with industrial reprocessing lies in the fact that all the radioactive materials are divided between these numerous facilities. From the safety point of view, reprocessing is the most complex part of the entire fuel cycle.

This presentation describes some of the main features of safety experience feedback in the French reprocessing plants.



## 2. SAFETY ASSESSMENT OF REPROCESSING PLANTS.

For the major nuclear facilities, three key safety functions are identified in safety organization :

- the operator, which has responsibility for its facility,
- the safety authority : the Nuclear Facilities Safety Directorate ("Direction de la Sûreté des Installations Nucléaires" : DSIN). DSIN reports to the Minister of Industry and to the Minister of Environment,
- the technical expertise in safety : the Institute for Nuclear Safety and Protection ("Institut de Protection et de Sûreté Nucléaire" : IPSN) is the organization which carry out research and development programmes, and provide the ministerial departments and related organizations with safety evaluations and other types of expertises in the field of nuclear protection and safety.

The safety assessment of the reprocessing plants is conducted within the framework of safety reports and their examination. The responsibility for these studies and their presentation is thus primarily borne by the builder or operator, i.e. COGEMA (Compagnie Générale des Matières nucléaires). These reports are then analysed and deductions made from them by IPSN, which presents its judgement to the government authorities so that the appropriate decisions can be taken. In addition, several IPSN engineers work at La Hague ; they determine which tests are important from a safety point of view, attend these tests and analyse their results.

As an example, examination of the preliminary safety report of plant UP3-A at La Hague began in 1979-80 ; it was followed by a licence to create this basic nuclear facility being granted in May 1981. This first examination was followed by many other safety studies about the plant, from 1981 to 1992.

A nuclear facility can be considered to be safe if the arrangements taken in its design, construction, operation and decommissioning make it possible to ensure:

- protection of workers and members of the public from ionizing radiation during normal operation,
- prevention of accidents and mitigation of their consequences.

It is therefore necessary that each facility be designed, built and operated in such a manner that :

- the conditions characterizing the normal operating domain of the workshop are maintained,
- any excursions outside this domain can be controlled.

The safety assessment of reprocessing plants is based upon three complementary approaches :

- compliance with the rules and regulations of the profession,
- analysis of the potential risks, performed using deterministic methods or probabilistic methods (when the reliability data allow sufficiently accurate calculations to be made),
- review of experience feedback.

### 3. IMPORTANCE OF EXPERIENCE FEEDBACK AND SAFETY IMPROVEMENTS.

#### 3.1. Radiological protection of operating staff.

##### 3.1.1. Staff radiation exposure results.

Experience shows that :

- methods for calculating shielding equipment used at the design stage include large safety margins,
- the personnel exposed to the lowest radiological hazard are those working in high activity workshops, whereas those who work in medium activity workshops are most exposed. This is explained by the fact that in plant UP2, part of the upkeep and maintenance operations in medium activity workshop involves contact, which is, of course, not the case for high activity workshops. This demonstrates, *ipso facto*, that the part of the exposure received in the presence of fixed biological protection is negligible.

The legal limits for the equivalent whole body dose of staff working in an ionizing environment have been fixed at 50 mSv/year. At the present time, the average annual dose per staff member for the La Hague establishment is approximately 1.5 mSv for the whole organism (0.15 rem), the collective dose amounting to approximately 7 man.Sv for the whole organism (700 man.rems) over one year. These values concern all of the staff monitored by the Radiological Protection Service (including the staff of non-COGEMA companies) and cover all of the activity of the establishment, including the parts where dismantling is taking place. The values for the operation itself are therefore lower than the values shown above (in particular, the value of the collective dose affecting the operation of reprocessing plants is less than 5 man.Sv).

##### 3.1.2. Exposure reduction.

The exposure of the personnel decreases from year to year as a result of the introduction of improvements into the methods of UP2 plant operation. Improvements of the same nature are being introduced into the operation of UP2-800 and UP3-A plants and the STE3 effluent treatment station ; in addition, other innovations which make maintenance and repair operations easier have also been introduced.

#### 3.2. Experience relating to the containment barriers.

The first barrier is composed of the equipment of the process (piping, instruments etc.) and of any systems directly associated with these (in particular the vents of equipment). The process installations for gases from this equipment form an integral part of this barrier. The integrity of this first barrier is subjected to special surveillance. The principal means provided in the context of this surveillance are the following :

- high level alarm and means of taking samples in the drip-trays sumps,
- arrangements for introducing endoscopes and cameras into certain cells,
- means of flushing the drip-trays and verifying, by sample taking, the level of contamination after flushing,
- checking the radioactivity of heat transfer fluids,
- surveillance of the level of contamination of the air extracted from the space adjacent to the first barrier,
- continuous surveillance of the gaseous effluents.

The second barrier is made up by the walls of the red area and the associated devices (in particular ventilation and protection against alpha, beta, gamma and neutron radiation), which contribute to ensuring protection against radiation, and also to the containment of the radioactivity whenever the integrity of the first barrier is no longer certain. The integrity of this second barrier is also afforded with special monitoring.

To these two containment systems is also added, mainly for the purpose of surveillance and of limiting the consequences of incidents on the environment, a system surrounding the whole plant, which amounts to the general surveillance of the site.

The confinement system installed at the UP2 plant has proved its worth, even with the ventilation halted (including one during more than one day in 1980), since all of the rare contamination incidents which did arise were easily controlled.

The system of barriers installed in the new installations take account particularly of the experience gained on the UP2 plant, by effecting an improvement in particular by the complete separation of the gaseous effluents from the process and by the ventilation of the buildings.

On the new plants, no significant contamination incident was detected, in spite of several unplanned halts of the ventilation system.

### **3.3. Emergency Plans.**

The emergency plans do not play a direct role in the assessment of the suitability of the design arrangements. The purpose of the emergency plans is to establish the management system and resources for countering unforeseen situations or severe beyond-design-basis accidents which can have consequences for the site and/or the surrounding area.

These plans have never been called into action since their creation for lack of need.

Nevertheless, full size emergency exercises, with the setting up of crisis cells and the participation of the authorities, and with evacuation of staff, are carried out periodically on the basis of a supposed accident scenario.

### **3.4. Feedback of experience related to incidents.**

The following table summarizes the incidents declared by the COGEMA establishment at La Hague between 1978 and 1989.

**Incidents at the La Hague COGEMA establishment  
from 1978 to 1992.**

YEAR	NUMBER OF INCIDENTS
1978	7
1979	5
1980	6
1981	8
1982	4
1983	3
1984	6
1985	8
1986	8
1987	3
1988	3
1989	3
1990	3
1991	3
1992	4
<b>FOR 15 YEARS</b>	<b>80</b>

Of these 80 incidents :

- 64 occurred during normal operation of the facilities, most being caused by equipment failures,
- 11 occurred during normal operation of the facilities, but happened during maintenance operations,
- 5 occurred during inter-campaign shutdown, during maintenance operations.

The great majority of the 80 incidents declared in 15 years by the COGEMA establishment at La Hague have had no notable radiological consequences ; but the following incidents need to be mentioned :

- on 6<sup>th</sup> January 1981, a fire broke out in a graphite waste storage silo (originating from gas cooled reactor fuel) and resulted in a limited release (several curies), mainly of caesium, into the environment. In new plants (UP3-A and UP2-800), radioactive waste (originating from light water reactor fuel) is packaged as it is produced, which avoids the accumulation of waste in dispersable form.
- May 1986 : exposure of three workers of an external company (non COGEMA) during work on pipes connected to tanks containing high activity solutions.

The main significant event to affect the UP2 plant and which could give rise to feedback to the UP3-A plant, was the complete loss of electric power after a fire in an area which was

common to the power sources (normal and standby) and the command wiring (15<sup>th</sup> April 1980). The main lessons drawn from this incident are the following :

- The main electric station of the establishment was recast in an attempt to achieve two independent paths, for both power and control feeds, each capable of full-power operation. This arrangement has now been in service for several years.
- The principle of separation into two independent paths has been used right up to the main distribution boards in the new-generation units.
- In the case of functions which, if lost, could lead to serious consequences (cooling of the ponds, cooling of the fission products concentrated solutions, sweeping out of radiolysis gases, cleaning out of the centrifuge setting tank etc.), a final local backup arrangement involving redundant diesel generators, independent of the main system feeding the plant, was installed in the new plants.
- It was noticed that the speeds of temperature raising in the fission product concentrated solution intermediate storage tanks and in the ponds were considerably lower than those expected from the design calculations. In fact, a large margin exists between the design thermal powers and those which are actually called for in the working plant.

### **3.5. The importance of safety experience feedback : safety improvements.**

The lessons drawn from these various incidents have enabled major insights, and have resulted in corrective action to further reduce their frequency and consequences.

In general, a considerable effort has been made to incorporate the experience from the UP2 plant in the design of the UP3-A and UP2-800 plants, in particular by the setting-up of working groups (consisting of the main contractor, the operator, the sponsor of the process, the engineers) to reflect on themes related to quality of the process and safety .

Improvements in the safety assessment of new reprocessing plants (UP3-A and UP2-800) arose from having set the highest safety standards for these plants, with the use of high technology, some of it specific to the reprocessing field, but much involving other sophisticated technologies such as computers, electronics, new maintenance concepts, advanced mechanics and new materials (the use of zirconium to make the large dissolvers is just one such example).

As examples of feedback from safety experience, the principal improvements relate to the following fields :

- The reliability of electrical power supplies is set to a very high level, so that an incident such as the power blackout of plant UP2 that lasted several hours on 15<sup>th</sup> April 1980 is now more unlikely,
- Functioning takes place under remote control (from a centralized control room in the case of plant UP3-A). This sophisticated control system allows to supervise all the events occurring in the plant and to take the remedial actions as required by the situation. Only some locally controlled operations still exist in lightly-exposed areas (such as preparation of new packages for waste).
- Sampling during normal operation is carried out using automatic devices, with no break in the confinement or protection against radiation,

- The organization of confinement of radioactive materials and of ventilation networks is improved :

- . more rigorous continuity of primary containment,
- . complete separation of ventilation arrangements for equipment, in the primary containment system and the second system.

- In the packaging of plutonium oxide, aluminium boxes enveloped in vinyl polychloride are replaced by welded stainless steel casings, which is a more reliable solution.

- More effective radiological surveillance devices are used.
- Maintenance operations can be carried out under normal conditions, i.e. without exceeding the exposure limits of the zone involved, due to :
  - . the thorough preparation of operations in radioactive environment for maintenance and repair,
  - . modular design enabling the defective standard equipment (pumps, valves, stirrers and probes of mixer-settlers, shielded filters, parts of sampling benches, ejector nozzles) and the waste removal bins to be replaced and removed directly to zone 3 (yellow area) without loss of confinement and with protection against radiation by means of mobile equipment replacement casks (MERC).

The special equipment of zone 4 (red area) requiring maintenance (for example the shearing device and the vitrification devices) are designed so that maintenance can be carried out by remote manipulation in zone 4, essentially by means of specialized cranes installed in zone 4, which can themselves be serviced in a garage from zone 3 (yellow area). Certain workshops (shearing and dissolution, packaging of technological wastes AD2 and dry unloading T0) are equipped with heavy remote-controlled manipulators, which were specially developed and can be serviced and repaired in zone 4.

- The waste are packaged as they are produced :
  - production of very high activity glass (facility T7) retaining more than 99% of the fission products and alpha activity in a small volume (0.15 m<sup>3</sup> per tonne of reprocessed uranium),
  - production of bitumen in a new liquid waste treatment station (STE 3) which came in operation in 1989,
  - production of cemented process waste holding the metallic parts of the fuel assemblies (end-pieces and hulls), in the T1 facility,
  - production of cemented technological waste and compacted drums in a new building (AD2) which came in operation in February 1990.

This packaging of radioactive waste as they are produced is an important innovation which avoids the accumulation of waste in dispersable form. The waste are produced in accordance with a set of specifications drawn up in advance ; conformance of waste packages to the specifications is checked as part of a product quality control programme, largely based on process operation quality control.

- Reduced average exposure of staff and reduced releases of liquid and gaseous effluents demonstrate the effectiveness of this safety feedback .

A great step forward has been made in the design, construction and operation of UP3-A plant, which can be considered as the most advanced reprocessing plant actually existing. The experience feedback will naturally continue to be used with a view to further improving the safety of the operation.

#### **4. UP3-A STEP BY STEP START UP AND UP2-800 COMMISSIONING.**

##### **4.1. UP3-A step by step start up.**

There were two main steps in the commissioning process : "inactive" commissioning, which involves testing the plant with non-radioactive materials ; and "active" commissioning, in which radioactive materials are introduced.

At the end of the construction phase, a smooth transfer was completed from the construction teams to the test teams. The continuing assistance of the former was used for the necessary adjustments and modifications, which gave a supplementary guarantee for the safety of the plant.

Commissioning a nuclear plant incorporating many chemical and mechanical processes must be carefully planned and integrated into the construction programme. A stepwise approach was used in order to achieve maximum confidence in the plant. Between the various stages of commissioning some improvements were made to the facilities.

From the beginning of the test programme, future COGEMA operators were progressively introduced into the test team. During this period, these future operators worked closely with the designers, equipment makers and constructors in the conduct of the tests. This ensured a smooth transfer of the facilities to the future operating teams and provided a key part of the training programme. During these tests, the personnel acquired visual, and practical knowledge of the equipment housed in the high-activity cells, which are no longer accessible after "active" start up.

UP3-A's normal operating team consists of about 400 people. Of these, 25 % are experienced individuals from the UP2 facility and the remainder are new staff recruited for UP3-A.

The first zirconium dissolver of facility T1 arrived at the La Hague site in the second half of February 1990, and the second arrived during March. Facilities T1, T2, T3, T4 and T5 were thus ready to begin full operation in August 1990. The vitrification facility T7 was commissioned in 1992.

##### **4.2. UP2-800.**

In order to meet the need for reprocessing of Electricité de France (EDF) fuel in the future COGEMA has decided to increase the nominal annual capacity of the UP2 plant to 800 tonnes. A number of new buildings have been constructed, some of which are already in operation:

- the new La Hague pond (NPH) and the new flask unloading facility came into operation in 1981,

- R1 building will perform shearing and continuous dissolution of the fuel, starting end of 1993.
- R2 building will house the first solvent extraction cycle with partitioning of uranium and plutonium. It has the same status as the R1 building.
- R7 started operation in June 1989 and produces glass holding the fission products from the irradiated fuel. This facility has three vitrification lines and is currently vitrifying the backlog of UP2 fission products concentrates that have been stored during the past plant operation.

However, the UP2-800 plant will still make use of some of the older units for uranium and plutonium purification (MAU, MAPu), as these units were capable of such high throughput. They will be replaced by a new workshop (R4) at the beginning of the 21<sup>st</sup> century.

For the design, manufacture and commissioning of the new units of the UP2-800 plant, feedback is used very widely, in particular that acquired recently during the operation of the UP3-A plant (improvements made during the step by step start up).

## 5 - CONCLUSION.

In France, the reprocessing facilities in operation or under construction are relying on a very extensive experience accumulated over the past 35 years. Feedback is considered to be very important in the design, the surveillance and the control of the process, with a view to the continuous improvement of safety.

Improvements in safety have been introduced especially due to the standardization of equipment, to the methods used for preparation of interventions in a radioactive environment, to the use of mobile equipment replacement casks (MERC) for repair and maintenance operations, and to the continuous and improved training of staff. The reduction in the average individual dose to staff over time also demonstrates the effectiveness of this feedback system.

In the next few years, safety issues will centre around:

- the assessment of the safety of the new workshops (R1 and R2) of plant UP2-800 and review of the safety options of the workshop R4 project,
- bringing up to standard the older workshops of plant UP2 which are to be integrated in plant UP2-800, particularly as regards confinement and ventilation, fire risk avoidance, reliability of the electrical power supplies and for pond NPH contingent additional parasismic work,
- the future of the other older installations,
- improvement of radioactive waste management in the plant, particularly with a view to reducing its volume,
- depleting and packaging the backlog of waste (particularly sludges, hulls, end fittings and resins),
- problems raised by the reprocessing of MOX fuel (mixed uranium plutonium oxide).

Monitoring of the plants operation from the safety viewpoint must be continued (incidents, dosimetry balances, radioactive effluents and waste production balances, and quality of operation) with particular reference to licensing of industrial operation of the new plants ("active" commissioning of UP2-800 is planned for the beginning of 1994).



**BNS/OECD-NEA Symposium on the**  
**SAFETY OF THE NUCLEAR FUEL CYCLE**  
**BRUSSELS, 3-4 June 1993**

**ENVIRONMENTAL SAFETY OF REPROCESSING**  
**The experience of la Hague**

Jacques SIMONNET  
COGEMA  
Branche Retraitement  
Chef du Service Qualité-Sûreté

Abstract :

The choice of a specific fuel cycle depends on several different factors : economics, security of supply, environmental impacts, but also safety features. A really sound and accurate assessment of all those factors can only be based upon industrial experience and repeated records of performances. Namely, reprocessing of LWR fuels has now come of age and exhibits meaningful safety records, which are shown in this paper. From a broader viewpoint, it will be hinted, too, that the attractive safety features of reprocessing not only lie in its process performances, but also in its contribution to an overall fuel-cycle option, which ensures recycling of nuclear materials, as well as a safe disposal of wastes, 99% of the activity being vitrified.

Résumé :

Le choix d'un schéma de cycle du combustible dépend de nombreux facteurs : économie, sécurité d'approvisionnement, impact sur l'environnement, et aussi sûreté des installations. Une évaluation vraiment solide et précise de ces différents facteurs ne peut être fondée que sur une expérience industrielle et sur des données concrètes prouvées. Dans cet esprit, le retraitement des combustibles issus des réacteurs à eau ordinaire a atteint sa maturité et démontre un niveau de sûreté significatif qui est mis en avant dans cet article. Dans une perspective plus large, il est également montré que l'intérêt du retraitement en matière de sûreté ne tient pas uniquement au procédé, mais aussi à sa contribution à une option de cycle du combustible complet, qui permet le recyclage des matières nucléaires, ainsi que le stockage sûr des déchets, 99% de l'activité étant vitrifiée.

# ENVIRONMENTAL SAFETY OF REPROCESSING

## The experience of la Hague

### 1. UP3 PLANT PERFORMANCE

The UP3 plant successfully started low-capacity operations in August 1990, and is ramping up according to schedule, with 350 MTU reprocessed in 1991, 450 MTU in 1992, and nominal capacity to be achieved in the 1994-1995 time frame. The design fuel burn-up for UP3 was 43,000 MWd/MTU ; minor modifications will soon allow the plant to reprocess fuels with burn-ups in excess of 50,000 MWd/MTU. MOX fuel can also be reprocessed, as was demonstrated for the first time in November 1992 with MOX from the German Wurgassen reactor. This will be implemented in sister plant UP2-800, now under commissioning.

Plant operations have met or exceeded all performance criteria for personnel exposure, effluent releases and waste volumes :

- **Personnel Exposure** : The average annual dose to operating personnel was 0.46 mSv in 1992, below COGEMA's design criteria of 5 mSv/yr and well below the maximum allowable dose of 50 mSv/yr. Specific personnel exposure has been reduced by a factor of 30 in the last 15 years to the current level of 0.15 man Sv/MWe for the La Hague site, to which the UP3 plant contributed only 4%, largely due to the remotely maintainable facility design and to the extensive use of automation in plant operations. (See Fig. 1 & 2).

Figure 1

 **ANNUAL EXPOSURE OF WORKERS IN CHARGE OF PLANT OPERATION AND MAINTENANCE**



Figure 2

 **OCCUPATIONAL EXPOSURE**  
Annual dose compared to production

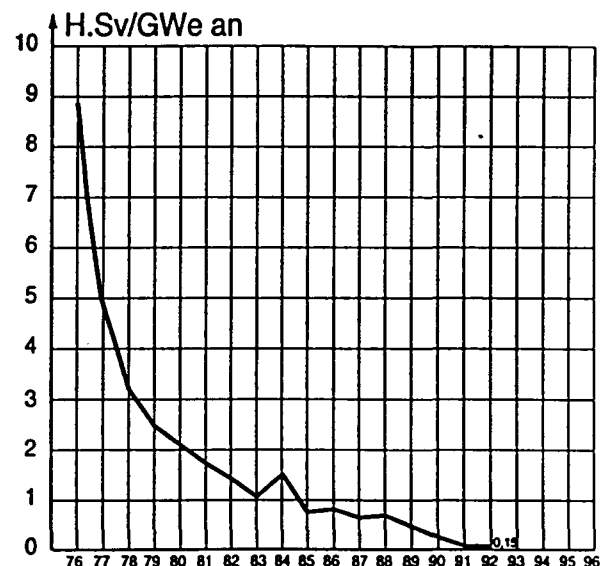

- **Radioactive Effluent Releases** : Although the UP3 and UP2-800 plants quadruple the reprocessing capacity of the La Hague site, effluent release limits were not raised by the regulatory authorities (See Fig. 3). Liquid effluent activity released to the sea continued to decline after UP3 start-up : the 2.9 curies of alpha activity in 1992 were more than fifteen times below the annual release limit, while the 2,607 curies of beta/gamma activity were more than fifteen times lower than the release limit (See Fig. 4). Modifications are taking place for further reductions.

Figure 3

**COGEMA-LA HAGUE RELEASES**  
(in % of allowable limits)

(in metric tons)	1990	1991	1992
Production	525.7	662.5	672.4
Capacity	1600	1600	1600

GAZEOUS RELEASES

	1990	1991	1992
$\alpha$ $\beta$ Aerosols	0.029	0.035	0.014
85 Kr	3.06	21.08	19.84
Halogenes	7.36	21.23	10.37
Tritium	1.15	1.24	1.38

LIQUID RELEASES

	1990	1991	1992
$\beta$ (except tritium)	18.47	6.82	4.50
Tritium	8.81	12.73	10.19
137 Cs + 90 Sr	12.86	16.05	9.32
$\alpha$	21.71	8.94	6.29

Figure 4

**RELEASES TO THE SEA**

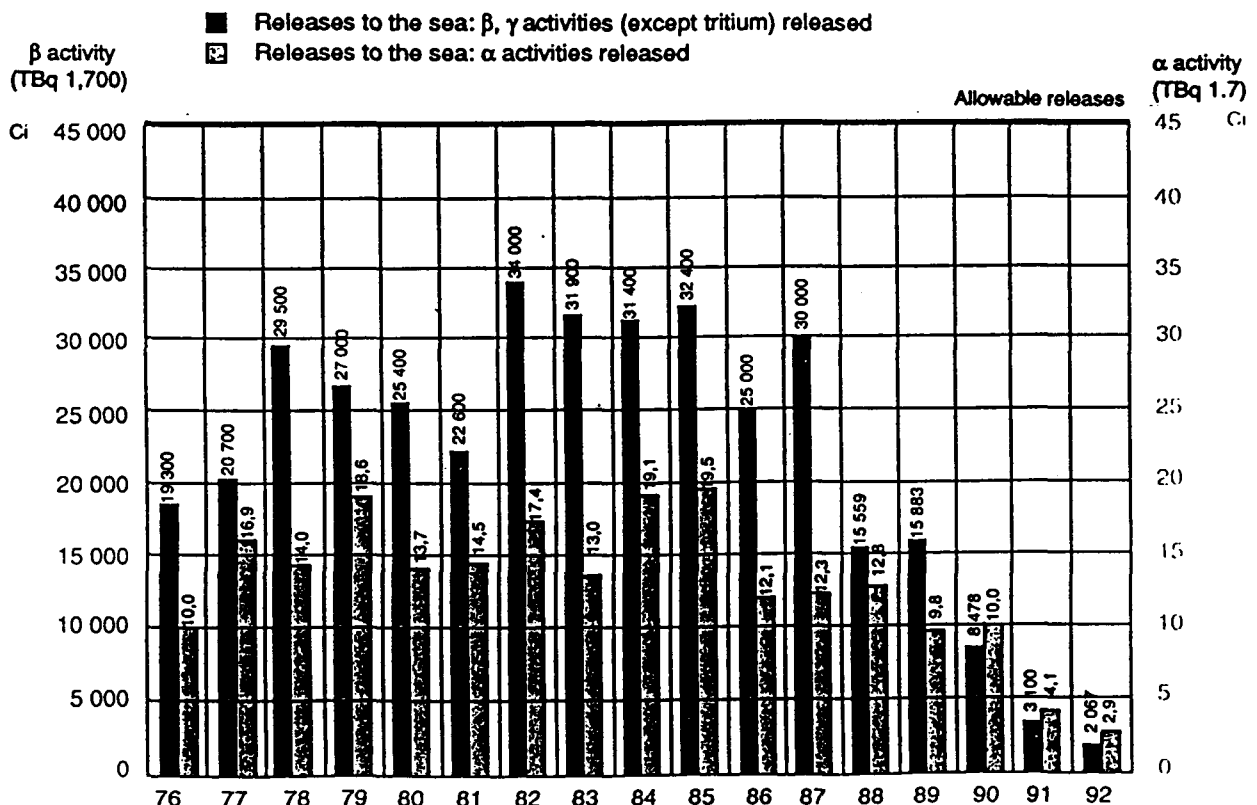

### - On-line waste conditioning

More than 99% of the activity is conditioned in glass, using the vitrification technology developed in France and implemented in the AVM facility at Marcoule, in R7 and T7 facilities at La Hague and in the Windscale Vitrification Plant at Sellafield. The final product, the fission product glass, is today the only HLW waste form licensed by the French regulatory body and foreign clients. Its confinement qualities are based on the over 15 years qualification programmes performed at CEA and on the active quality control and quality assurance programmes set forth by the operators of the vitrification facilities. The medium and low-level effluents are treated by precipitation, decantation and filtration. The resulting active sludges are conditioned in bitumen and produce Intermediate Level Waste. The quality of the bitumen waste form has been demonstrated after a comprehensive characterization programme performed by the CEA and acknowledged by the French Safety Authorities and foreign customers. The hulls and end-pieces separated from the irradiated fuel are conditioned by cementation, a process which was licensed by the French regulators, while Cogema continued investigating alternative possibilities (fusion and compaction). The other wastes, obtained at the reprocessing plant, originate not from the fuel itself but from the reprocessing operations, are called "technological waste". They are conditioned in concrete, a major part of it producing packages acceptable in a surface repository in France.

- Waste Volumes : Only 1.4 m<sup>3</sup>/tU of high-level and transuranic waste were generated by UP3 operations, compared to the 3 m<sup>3</sup>/tU initially estimated, while low-level waste, at 1.4 m<sup>3</sup>/tU, is half the original estimate. By 1995, HLW will have been reduced to 1 m<sup>3</sup>/tU with known technologies and processes ; the goal for the year 2000 is to reduce this to 0.5 m<sup>3</sup>/tU with improved immobilization processes (See Fig.5).

Figure 5



### **VOLUMES OF RESIDUES GENERATED IN UP3 BY tU (after conditioning)**

	Type of products	Solidification method	Specification UP3-UP2-800	Actual (1991)	Expected (1995)	Expected (2000)
Waste not compatible with current surface storage standards	Fission products	Glass matrix	130 l / tU	115 l / tU	115 l / tU	115 l / tU
	Hulls and end-fittings	Concrete	600 l / tU	600 l / tU	< 600 l / tU	150 l / tU
	Bitumen waste	Bitumen	630 l / tU	450 l / tU	0	0
	Technological residue	Grouted asbestos Concrete overpack	1700 l / tU	200 l / tU	200 l / tU	< 200 l / tU
	<b>TOTAL</b>		3060 l / tU	1365 l / tU	< 915 l / tU	< 465 l / tU
Surface waste	Technological residue	Grouted fiber Concrete overpack	3800 l / tU	1400 l / tU	1400 l / tU	< 1400 l / tU

(\*) extrapolation to 800 t/year throughput and same level of technology

As evidenced by all those results, the industrial mastery of reprocessing of LWR fuels has been achieved in the Cogema plants at La Hague. No significant incident in the operation has been observed. The excellent performances open the way to further waste minimization, concentrating the maximum possible activity in the glass.

## **2. SAFETY FEATURES OF THE RECYCLING OPTION**

Reprocessing spent fuels, instead of burying them directly, achieves two goals :

- the recycling of energetic materials,
- the safe conditioning of radioactive wastes in a minimal volume of package.

Turning towards the safety and well-being of future mankind, it should be generally accepted that we must both spare energy resources of the earth and refrain from accumulating plutonium in the underground. Recycling plutonium and reprocessed uranium is consistent with such a philosophy.

The environmental safety of the recycling option does not imply reprocessing only, but also :

- fuel fabrication
- MOX in-core management in LWR
- storage and transport of plutonium
- waste disposal

The available experience from several countries, on MOX fuel fabrication, transportation and management in reactor, gives full assurance about the safety of recycling on a wider scale. However, the waste disposal issue involves much higher stakes as to environmental safety, and it will be commented hereafter.

On Figure 6, masses to be buried are compared, respectively in the reprocessing and in the open cycle option. It shows that, by recycling once, plutonium mass is approximately halved, while uranium mass is divided by eight. Repeated recycling of plutonium, eventually followed by combustion in a fast-breeder, would further dramatically decrease quantities to be disposed of, for a given production of electricity.

The long-term safety of deep underground repositories is currently characterized in two ways :

- 1) The quasi-deterministic impact by release of radionuclides to the biosphere, after a very long time of migration : in the evaluation of such radiological impacts, the groundwater behaviour and the solubilities of radionuclides are determinant.
- 2) The hypothetical contact between man and the buried waste, in case of cataclysm or of human intrusion, which involves the total potential radiotoxicity of the waste at the time of contact. This radiotoxicity, beyond a century, is mainly dependent on the content of waste in plutonium and other actinides.

Figure 6



## REPROCESSING / OPEN CYCLE COMPARISON

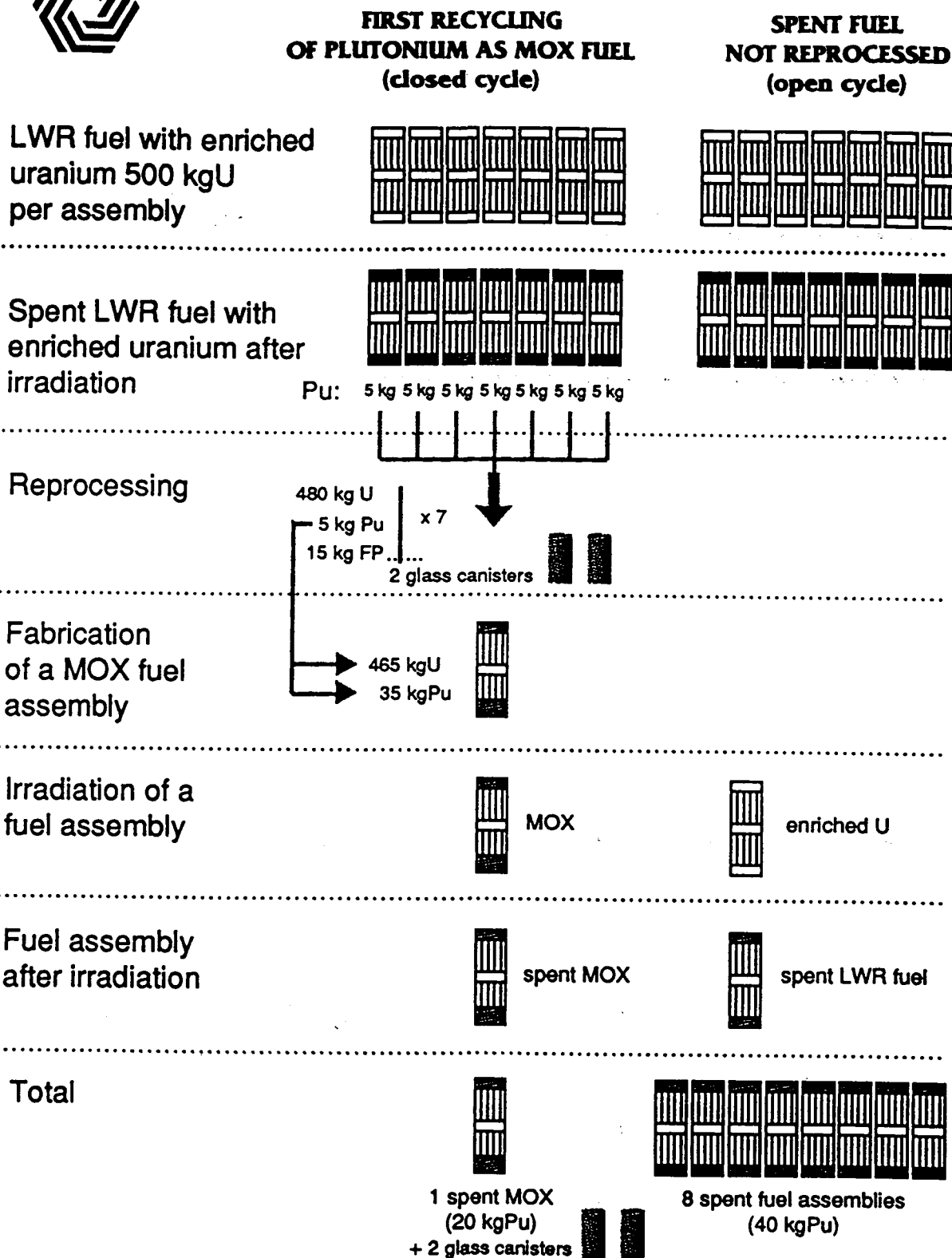

**Nota: 1 g of plutonium = 1 ton of oil**

Figure 6



## REPROCESSING / OPEN CYCLE COMPARISON

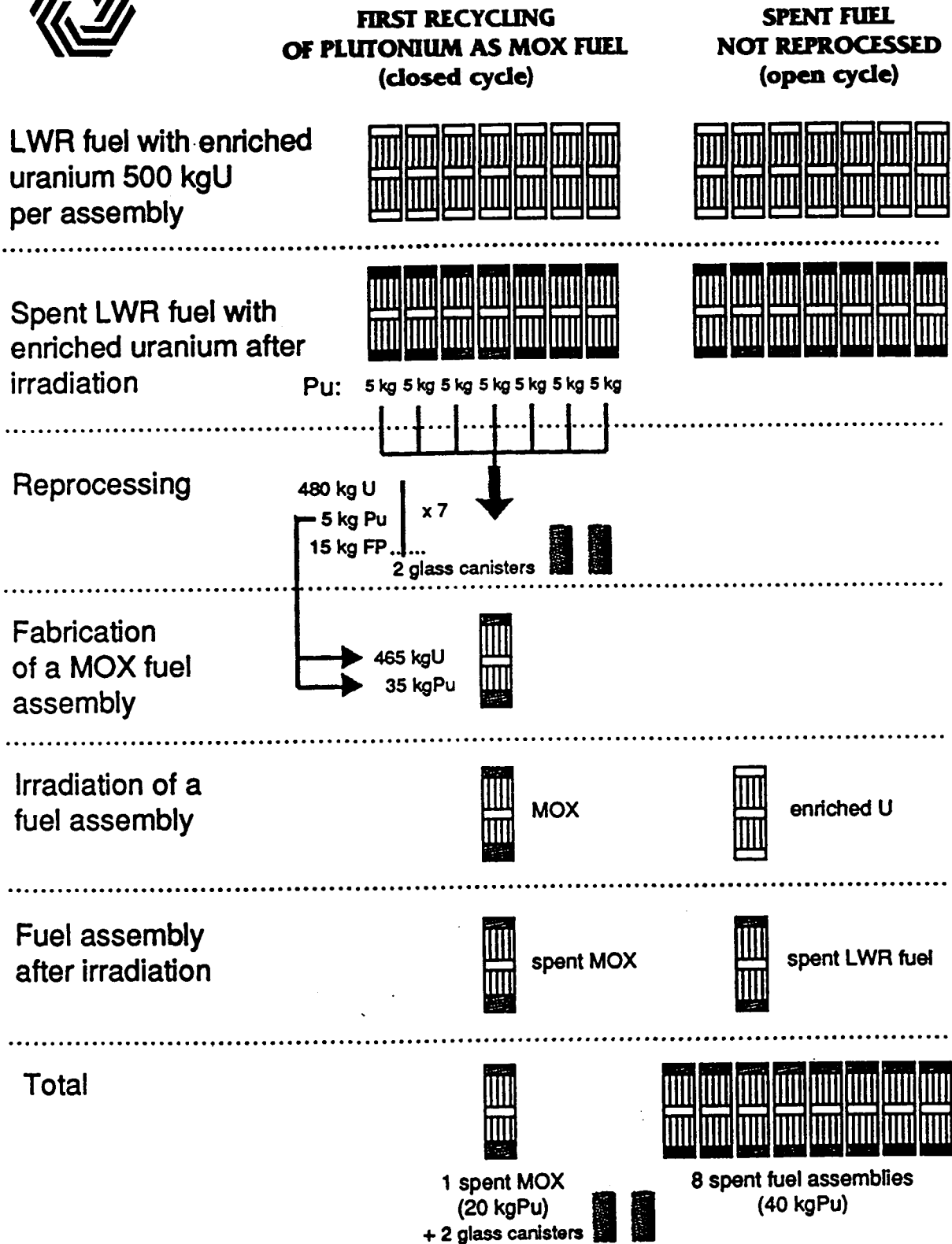

**Nota: 1 g of plutonium = 1 ton of oil**

In the first approach, the beneficial effect of reprocessing on the safety of geological repositories is well established, since the glass matrix is recognized as a very efficient barrier against the leaching and migration of fission products. Indeed, according to experts' studies, the radionuclides would not come back to the biosphere before 400 000 years.

Before such a late term, mankind's historical fate might introduce unexpected perturbations, because of crucial energy needs, of military ambitions, or simply because of died memories or sheer carelessness. As a consequence, the potential radiotoxicity might be the governing safety factor to consider first. In this second approach, the beneficial effect of reprocessing and recycling would be two-fold :

- reprocessing decreases the waste radiotoxicity, compared with direct spent-fuel disposal,
- reprocessing prevents from building up plutonium mines underground.

The latter point seems quite significant, for the known presence of products of high value might considerably increase the risk of a human intrusion after a few centuries, when the activity of fission products is no longer dissuading enough.

Of course, the quest of a minimal radiotoxicity would drive to the separation and recycling of other actinides : americium, curium and neptunium. This is still a matter of research, for example in the program SPIN, of CEA in France. We reproduce here two figures from CEA presentations, which illustrate the effect of actinide separation on the waste potential radiotoxicity, under two assumptions of separation efficiency : a decontamination factor of the glass set equal to 10 or to 100 (Figures 7 & 8). Fig.7, compares the evolutions of total radiotoxicity in several cases, where as Fig.8, focuses on the specific contribution of actinides in spent fuel and in glass.

Figure 7

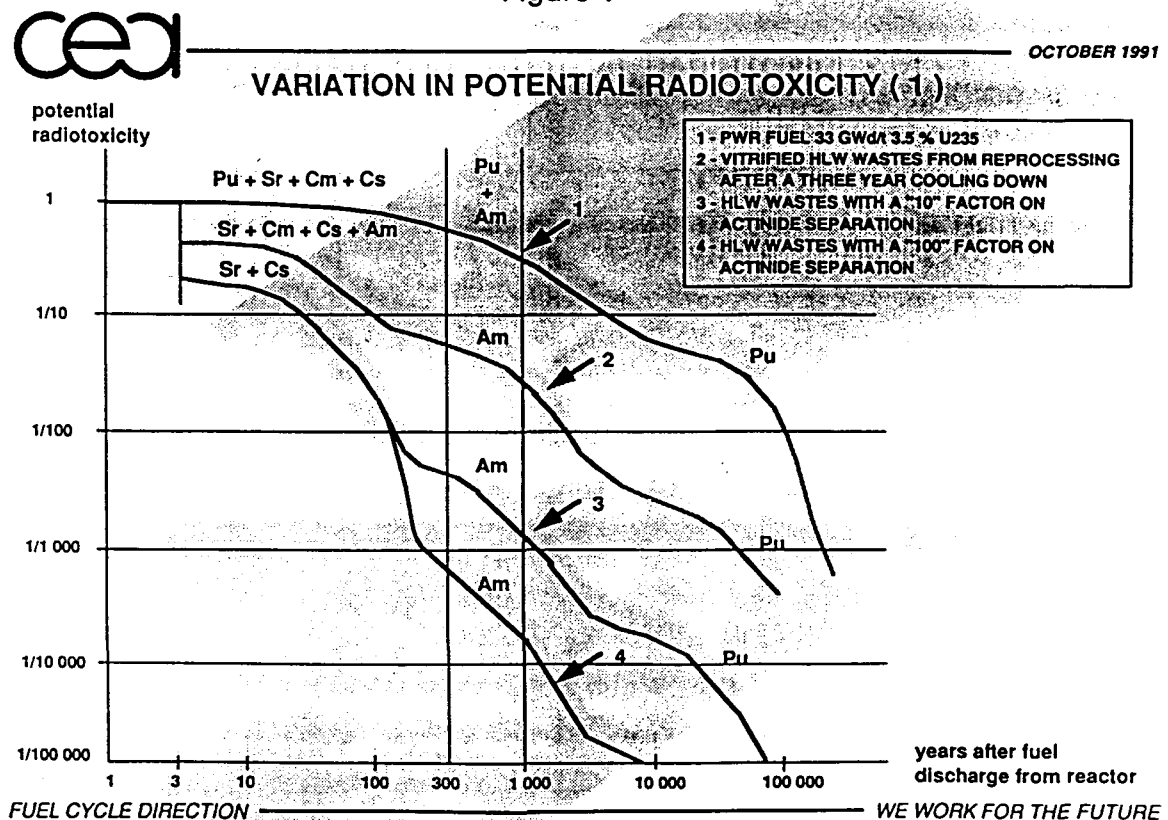



VARIATION IN POTENTIAL RADIOTOXICITY ( 2 )

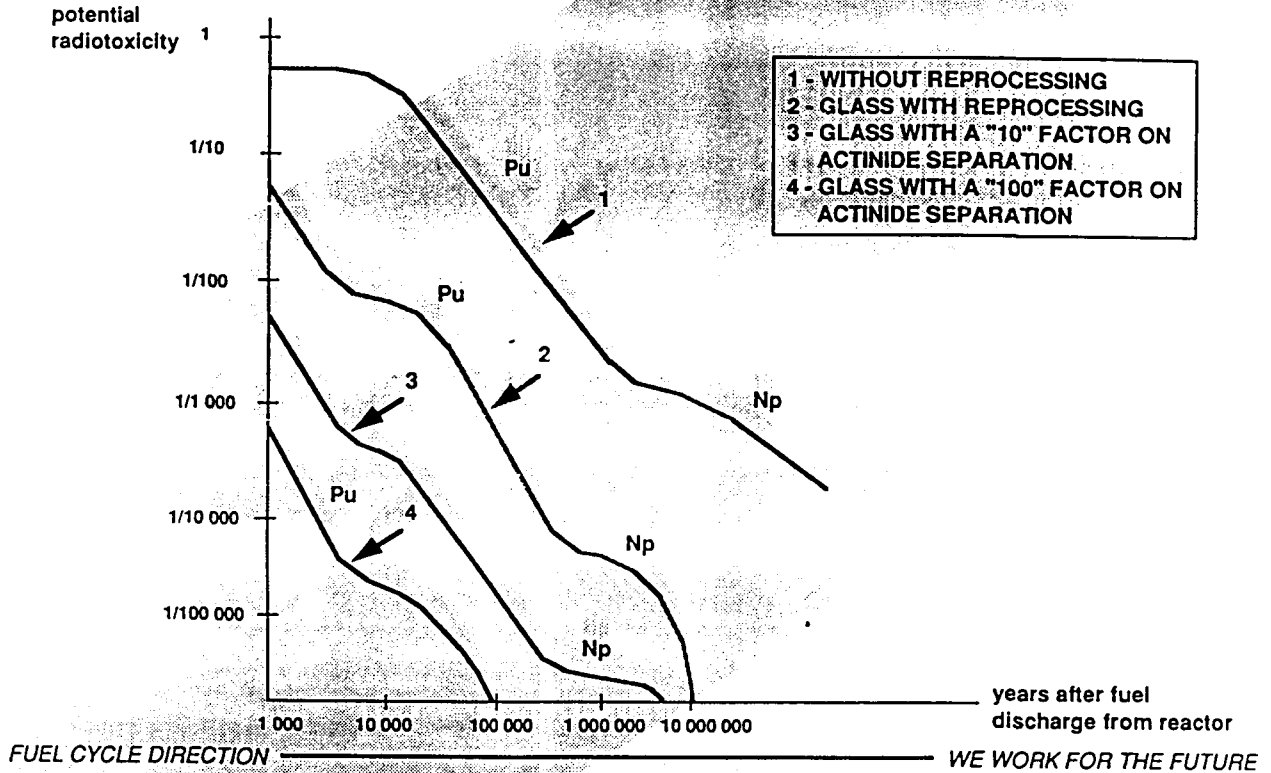

**CONCLUSION**

The very good records displayed by the La Hague reprocessing plant, as concerns safety, are essential for workers as well as for neighbours of the plant ; but also, they confirm the recycling strategy as a matter of fact. Man can live with plutonium, as long as he handles it on a proper way, and this is surely safer than to pretend to forget it underground.

THE UNIVERSITY OF CHICAGO

1950

DEPARTMENT OF CHEMISTRY

RESEARCH REPORT

NO. 100

BY

ROBERT M. HARRIS

AND

WILLIAM R. HAYES

**BNS/OECD-NEA Symposium on the  
SAFETY OF THE NUCLEAR FUEL CYCLE  
BRUSSELS, 3-4 June 1993**

**THE THERMAL OXIDE REPROCESSING PLANT AT SELLAFIELD  
'STATE OF THE ART' SAFETY ANALYSIS**

by

**J B Taylor  
G T Sheppard**

**BRITISH NUCLEAR FUELS plc**

**Abstract**

The Thermal Oxide Reprocessing Plant at BNFL Sellafield is a major investment which will take the science and technology of nuclear fuel reprocessing into the twenty first century. An overview of the plant and process is given and the magnitude of the civil structure indicated. The safety of THORP has been fundamental to all aspects of its design construction. The 'state of the art' safety methodology adopted to assess the radiological safety of the plant with regards to the workforce and public risk is demonstrated. For both normal and fault condition the adopted safety criteria is shown to be met with an adequate margin.

**Résumé**

L'installation de retraitement d'oxyde thermique (THORP) de BNFL à Sellafield constitue un investissement d'importance qui fera entrer la science et la technologie du retraitement de combustible nucléaire dans le vingt-et-unième siècle. Un aperçu global de l'installation et du processus est donné et l'ampleur de la structure civile est indiquée. Tous les aspects de la construction du projet de THORP reposent sur le concept de sa sécurité. La méthodologie de sécurité de l'état de la technique, adoptée dans le but d'évaluer l'installation sur le plan de la radioprotection à l'égard des risques auxquels sont exposés les employés et le public est démontrée. A la fois en état normal et en état de panne, on démontre que les critères de sécurité adoptés sont satisfaits avec des marges suffisantes.

## 1. INTRODUCTION

1.1 The safety analysis carried out on BNFL's Thermal Oxide Reprocessing Plant (THORP) could be considered to represent the coming of age of safety methodology on a nuclear reprocessing plant. For THORP, the assessors brought together 'state of the art' concepts in the approach to safety evaluation for a potentially hazardous plant. The approach influenced the mechanical, process and civil design ultimately leading to a facility that demonstrably meets its documented Design Principles and safety design criteria with regards to the protection of the public and work force.

1.2 The Thermal Oxide Reprocessing Plant (Figure 1) is the second major generation of irradiated nuclear fuel reprocessing plant to be built on the Sellafield site in the United Kingdom. The main building of the THORP complex is shown in Figure 1. THORP will receive enriched uranium fuel principally from Light Water Reactors (LWR) in Japan and Europe and Advanced Gas-cooled Reactor (AGR) in the United Kingdom. The design and construction of the Head End and Chemical Plant has cost about £1500M.

1.3 The conceptual design of the plant started in 1974. Following the successful outcome to a Public Inquiry detailed design commenced in 1983. Civil construction commenced in 1984 and commissioning is now in progress. The plant will be operational in 1993.

1.4 As the detailed design commenced a team of safety assessors and managers was put in place to service the project. The primary aim of the team was to demonstrate adequacy of safety at various stages of design, construction and installation to satisfy the Company's safety criteria and the requirements of the Regulatory Authorities. The safety assessment has generated extensive safety documentation with the design phase culminating in the THORP Design Safety Report.

1.5 The objective of this paper is to discuss the THORP design safety case with regard to the following topics.

- Plant areas of primary interest to safety assessors.
- The safety analysis methodology adopted.
- The major hazards identified.
- Examples of the assessed risk from the hazards.
- The extent and dimension of plant and the safety analysis.

1.6 Located to the south of THORP (Figure 1) is the THORP Receipt and Storage Facility which began operation in 1988. This plant is essentially a flask receipt, fuel removal (in bottles or containers) and fuel pond storage plant. The Safety Cases required for the design and operation of this section of the plant have been completed previously, and are not further considered in the THORP Design Safety Report or indeed, further in this Paper.

## 2. PLANT AREAS

2.1 The safety assessment for the THORP has been both extensive and detailed with all plant areas which could potentially carry radioactive material being examined. This paper is however, confined to those areas which the safety assessors would consider to be the most radiologically significant under both normal and fault conditions. Typically they are plant areas handling material of relatively high specific activity, or handling significantly large volumes of active effluents.

2.2 The THORP plant can be considered as the following principal areas (Figure 2).

- Head End Plant
  - i) Mechanical
  - ii) Chemical
- Chemical Primary Separation Plant
- Uranium Purification
- Plutonium Purification
- Uranium Finishing Plant
- Plutonium Finishing Plant
- Plutonium Store

2.3 Head End Mechanical: This plant has four main components; a Feed Pond Area, a Fuel Elevator, Fuel Shearing Cave and a Basket Handling Area. Fuel will be brought under water from the THORP Receipt and Storage Building in its multi element bottle (LWR fuel) or its fuel element container (AGR). Following venting and flushing operations the bottle/container is to be opened and fuel removed. It is then monitored to determine its history. The fuel is located on an elevator and is raised along a biologically shielded track out of the pond water and onto an incremental feed ram in the Shear Cave. Here the fuel is moved forward to be guillotined by a vertically acting shear. Small lengths (25mm - 100mm) of fuel and associated end fittings are guided into a basket located in one of three available dissolvers. On completion of the hot nitric acid dissolution process, (7M nitric acid), the basket with its stainless steel (AGR) or zircaloy (LWR) hulls (the remains of the fuel cladding) is withdrawn from the dissolver and taken to the Basket Handling Area. Here the contents will be monitored to determine an acceptable level of residual fuel.

2.4 Head End Plant Chemical: Following clarification, by centrifuge, the dissolver solution will be conditioned and placed in buffer storage tanks in preparation for feeding forward to the Chemical Separation Plant. Processes in the Head End Chemical Section wash the centrifuge solids and wash coarse fines removed from the dissolvers in preparation for dispatch from the plant. Liquid waste arisings from various activities in Head End are received, sampled and directed to an appropriate waste treatment process. The plant has a dissolver off gas treatment plant for NO<sub>x</sub> gas and carbon 14 removal.

2.5 Chemical Separation Plant: The primary objective of this plant is to separate the contents of the dissolver solution into its constituent parts; fission product, plutonium and uranium. This employs a Purex-type extraction process using tributyl phosphate diluted with odourless kerosene (TBP/OK). In addition it is required to collect, chemically treat (as required), monitor and discharge the associated effluents. The Primary Separation Plant in the Chemical Separation area will carry out the initial separation of fission products from the uranium and plutonium (Figure 3). This is achieved by use of two pulsed columns in series, HA and HS. The dissolver feed solution is fed into the highly active (HA) column where uranium and plutonium nitrates, in the solution, are extracted into a rising stream of organic solvent. The majority of fission products remain with the aqueous phase which is taken from the column as highly active aqueous raffinate. The solvent stream carrying uranium, plutonium and some residual fission products passes to the highly active scrub (HS) column. Here the solvent stream is scrubbed with clean nitric acid to remove residual fission products.

Two further pulsed columns LBX and LBS, are used to separate the uranium and plutonium. In the LBX column uranous nitrate, stabilised with hydrazine nitrate, is used to change the valency state of the plutonium from Pu(IV) to Pu(III) in the solvent phase. This permits plutonium to be back extracted into an acid aqueous stream, since Pu(III) is inextractable into the solvent. The uranyl nitrate in the solvent stream passes to mixer settlers where residual plutonium is removed (then returned to LBX column). The uranium bearing LBX solvent product is contacted with a reducing scrub solution in the LBXX mixer-settler to remove residual plutonium. The product is then treated with a dilute nitric acid back-wash in a second mixer settler the 1C. The uranium transfers to the aqueous phase and passes to the uranium purification cycles.

The LBX plutonium bearing aqueous stream passes to the LBS column where it is scrubbed with clean solvent to remove residual uranium. This stream passes back to the LBX column for uranium recovery. The plutonium nitrate solution passes on to an OK Wash pulsed column to remove residual solvent. The plutonium nitrate then passes forward to the plutonium purification cycle.

2.6 Uranium Purification: The uranium solution from the 1C mixer-settler is conditioned, heated and passed to the uranium purification mixer-settler. Here uranium, together with fission products and actinides transfer back to the solvent phase when contacted with TBP/OK. This solvent is then treated with hydroxylamine nitrate and dilute nitric acid. Any residual plutonium is reduced to a trivalent state and taken into the aqueous stream. To prevent uranium passing to the aqueous stream additional contacting with TBP/OK occurs. Finally the solvent, containing uranium, is transferred to an additional mixer settler and treated with dilute nitric acid to bring the uranium into an aqueous phase as uranyl nitrate to pass to uranium finishing.

2.7 Plutonium Purification: The plutonium bearing stream from the 1BS column is treated to destroy the hydrazine stabiliser and convert Pu(III) to Pu(IV). The liquid is transferred to a column denoted PP1. Here plutonium is extracted into 30% TBP/OK solvent which rises to the top of the column, being scrubbed with nitric acid as it does so and overflows into a second column PP2. Here the liquid is treated with hydroxylamine and dilute nitric acid reductant, the plutonium is reduced from Pu(IV) to Pu(III) and transfers to the aqueous phase and is washed with odourless kerosene. The plutonium nitrate passes, via an evaporation stage, to plutonium finishing.

2.8 Uranium Finishing: The function of the Uranium Finishing plant is to concentrate dilute uranyl nitrate following its purification and convert it to uranium trioxide powder which is packaged for transport. The basic route is to concentrate by evaporation and thermally denitrate the uranyl nitrate concentrate to uranium trioxide. The trioxide in powder form will be discharged to drums remotely which will then be lidded and sealed.

2.9 Plutonium Finishing: The function of the plutonium finishing cycle is to convert plutonium nitrate, arising from the plutonium purification cycle, into plutonium dioxide. The basic route is to take plutonium nitrate arising from the purification cycle, condition it to ensure the plutonium is in a quadrivalent state, and mix with oxalic acid to precipitate plutonium oxalate. After filtering and drying the resulting powder is calcined at high temperature to convert the oxalate to dioxide. The dioxide powder is then packaged for storage. A purpose built store is available for plutonium dioxide packages. This store has been designed to be operated remotely with minimal operator intervention.

2.10 The initial requirement for THORP is to reprocess 7000 t(u) of fuel in about 10 years. The mechanical Head End batch processes are designed for a throughput of up to 7 t(u) per day. The continuous operation Chemical Separation Plant has a design throughput of up to 5 t(u) per day.

There is liquor storage capacity between these plant sections to minimise operational interaction. The reference fuel has the following characteristics

- Fuel rating < 40 Mw/t(u)
- Irradiation < 40 Gwd/t(u)
- Initial Enrichment < 4% U235
- Cooling period 5 years > 5 years

### 3. SAFETY METHODOLOGY

3.1 The safety analysis for THORP employed a 'State of the art' approach to risk assessment from potentially hazardous plant culminating in the THORP Safety Case. The aim of the Case has been to demonstrate that the operation of the plant represents an acceptable risk to the workforce and members of the general public under both normal plant operation and potential fault conditions.

3.2 Due to the extent and complexity of the THORP project the plant was conceptually broken down into manageable areas/processes for safety assessment. For each area a team was assigned and maintained to ensure expertise was established for a specific area/process. Particular attention was given to interfaces between areas/processes.

3.3 The safety methodology for THORP has consisted of a self consistent set of logical steps composed of:

- establishing acceptable radiological design standards and criteria for both normal operations and fault conditions.
- assessment of the operation under normal operating conditions.
- fault/hazard identification.
- safety assessment for the plant under fault conditions.
- sensitivity analysis on the safety analysis.

Throughout the safety analyses consideration was given to available design alternatives to ensure failure frequencies and risks from potential faults were ALARP. Where appropriate cost benefit analysis has been employed to demonstrate the principle. The safety methodology has been supported by a comprehensive quality assurance programme on the methods used, the software employed and the results generated. A generalised flow diagram of the safety methodology is given in Figure 4.



#### 4. CRITERIA

4.1 Radiological standards and criteria against which to judge the acceptability of risk from plant to the workforce and public, under both normal, potential fault conditions and external hazards have been established by BNFL. Due consideration was taken of the recommendations of the ICRP<sup>(1)</sup>, other relevant international agencies and the deliberation of the NRPB<sup>(2)</sup>.

4.2 For normal operation of the plant, criteria are available for judging the adequacy of risk to the operators and workforce associated with the plant. The primary criteria for the operators on THORP are set down as worker average annual dose and maximum individual dose targets. The adequacy of the plant under normal operation is judged against these targets. Similarly, annual dose targets for members of the public due to exposure from the normal operation of THORP are established. The safety of the plant under normal operating conditions is judged against these primary dose criteria. For both the workforce and members of the public due regard is taken to ensure doses are as low as reasonably practicable (ALARP). In addition cognisance is taken of the requirements of the Certification of Authorisation for effluent discharges, granted by government departments.

4.3 For fault conditions that could potentially arise on plant, criteria have been developed to judge the acceptability of risk from the Sellafield site. An appropriate allocation of the site risk, for fault conditions, has been assigned to the THORP. The underlying criteria are that the summed risk of death from operations on the site to members of the public should be less than  $10^{-6}$  per year and that the summed risk of death for a worker on a plant should not exceed  $10^{-5}$  per year. Due consideration is given to aerial and marine discharges under normal and fault conditions and the consequence to the critical groups evaluated.

4.5 In addition to meeting frequency and risk targets identified in the criteria, the actual failure frequencies and risks from potential faults are evaluated to be ALARP, all relevant factors being taken into consideration.

4.6 In assessing the ALARP principle for routine occupational radiation exposure, available design alternatives have been viewed against their potential for radiation dose reduction. Where necessary cost benefit analysis has been employed, adopting appropriate monetary evaluations of the man Sv.

---

(1) International Commission on Radiological Protection

(2) National Radiological Protection Board (UK)

## 5. NORMAL OPERATIONAL RISK

5.1 The risk to the workforce from whole body radiation exposure (annual maximum and average dose) has been evaluated on THORP by a comprehensive examination of the proposed operating routine and maintenance requirements for equipment on the plant. A computerised software package has been developed which produces a predictive annual dose budget for the plant. Predicted maximum and worker group average annual whole body dose is calculated automatically. The package can be used as a design tool to identify operations which could lead to potentially 'high' operator doses, or worker groups who are particularly vulnerable, to accumulating 'high' doses, by the nature of their work. The ALARP principle may then be adopted to identify engineering or operational solutions to reducing doses.

5.2 For extremity doses, specific analysis has been undertaken in the area of highest operator intervention. Extremity doses were calculated on the basis of measurements on existing operational plant. For THORP, experience from operational plant, in general, demonstrates that extremity dose targets will be achieved.

5.3 Worker inhalation dose can be judged to be optimised to meet the appropriate criteria, due to enhanced design and operational features to be employed in THORP. Such features include defence in depth arising from purpose designed ventilation systems, high integrity plant and equipment carrying active material, adequate health physics control and instrumentation, encompassed by a comprehensive building evacuation procedure in the unlikely event of airborne contamination being detected. These features will reduce further the already low levels of inhalation dose experienced on operational plant.

5.4 The risk criteria for the public, (critical groups), during normal operation has been established as an annual dose target for THORP. This represents some fraction of the site risk, for the normal operation of the plant. To evaluate this risk consideration is given to the chronic long term exposure of the critical groups from routine aerial and marine discharges from the plant. The dose impact by these two discharge routes are independent and the critical groups addressed are distinct. Interacting dose contributions are negligible.

5.5 Environmental modelling techniques, that are well established for the Sellafield area, are used to predict annual chronic exposure doses to the critical group from the two discharge routes. In these analyses due consideration is given to the effects of weather conditions, the geometry of THORP building and the height of the discharge.

5.6 As the plant has developed safety analysts, in conjunction with engineering teams, have evaluated the results of the predicted risk to the critical groups against the adopted criteria. The ALARP principle has been adopted by quantified cost benefit analysis, where appropriate, to evaluate expenditure on effluent discharge reduction plant. The ALARP principle has also been used when considering the integrated UK, European and World dose from normal operation of the THORP.

## 6. FAULT/HAZARD IDENTIFICATION

6.1 To evaluate the risk to the workforce and the general public (critical groups) from the THORP under potential fault condition it has been fundamental to the safety analysis to have a rigorous hazards identification assessment.

For the Hazard Identification there have been five main methods for identifying the potential hazards arising from THORP operations:

- Review of Literature
- Prior operating experience
- Hazard and Operability Studies
- Individual Safety Professional Assessment
- Research and Development.

A literature review to identify inherent hazards presented by the materials to be handled in the THORP process was both wide and in depth. Similarly, a vigorous review of operating experience has been carried out on Sellafield and other facilities. These reviews are identified in the Safety Case and the THORP design incorporates improvements over existing plant from the operating experience with these plants.

One of the more important routes to hazard identification has been the THORP Hazard and Operating Studies. These studies have been carried out in two stages, HAZOP I and HAZOP II. The HAZOP I examined the plant area by area to identify potential generic fault conditions. The HAZOP II is a detailed rigorous examination of each line, vessel and instrument for potential fault conditions. Similarly batch processes on THORP were examined by the HAZOP II method. Where required actions were placed on designers and safety assessors to resolve the implications of identified potential fault conditions.

This detailed and comprehensive examination of the design, item by item or operation by operation by the HAZOP team is the foundation for the confidence that a thorough examination has been undertaken to identify hazards or operability problems in the THORP design.

Throughout the THORP safety assessment, individual assessment by safety professionals has been used to complement the other hazard identification techniques and forms an important contribution to the detailed accident risk assessment.

Extensive research and development has been undertaken to increase the understanding of the behaviour of process and equipment when subject to both normal and maloperation. The use of such work to understand the behaviour of the shear machine, the dissolver, the pulsed columns and the evaporators and many other areas is reported in the Safety Case. Such work has assisted in making deterministic safety demonstrations. The work has also assisted in defining those faults which could result in hazards and which have then been assessed using probabilistic risk assessment (PRA) methods.

Extensive research and development has also been undertaken to understand, and quantify the operators behaviour during control of the plant under normal and maloperation conditions. The development of the THORP Human Factors Assessment Strategy commenced in 1987. The strategy has been specifically refined and tailored to the THORP project.

There is confidence that the strategy has addressed all relevant Human Factors assessment areas within the scope of the THORP Safety Case, and the assessments have had significant impact on certain design and operational characteristics of THORP.

## 7. SAFETY ASSESSMENT

7.1 For the assessment of the risk from THORP the best available 'state of the art' techniques have been used. The assessment of hazards is primarily based upon:

- deterministic arguments, (Figure 5) and/or
- probabilistic risk assessment (Figure 6)

In order to dismiss or, define and quantify, particular fault paths and scenarios the safety arguments cover normal plant operations and fault or incident conditions. For normal operations and very frequent events like start up, shut down and washout, a deterministic argument is employed. These operations must be shown to have such robust safety features that no combination of conditions within the operating limits (and in practice in large regions outside them) is physically capable of presenting a hazard.

7.2 The robustness of the process under normal operating conditions is established by determining the critical values of the physical and chemical properties which bound safe operating regimes. For example, should containment form an essential safety feature, its response to any challenge should be fully understood and known to be adequate beyond any reasonable doubt. Defining and establishing this safe operating envelope forms the basis of the deterministic element of safety assessment.

7.3 If the process or design variables are allowed to breach this envelope, confidence in safety decreases and, in certain circumstances, if the condition is allowed to continue, the process may become inoperable or dangerous. Two main groups of events leading to such conditions are considered.

These are:

- i. fail-danger pathways within the plant and
- ii. extreme external events such as earthquakes and flood.

#### The Deterministic Approach (Figure 5)

7.4 The definition of the safe boundaries of operation for particular hazards is generally achieved from available literature or from research work. Work has been done to support most of the hazard assessments for THORP (eg criticality limits, explosive concentrations of hydrogen, hydrazoic acid and carbon monoxide; limiting behaviour in certain equipment such as pulsed columns, dissolvers, evaporators etc, and physical data on chemicals, reactions, equipment materials etc). The resulting data have been used to demonstrate the robustness of the operations in THORP not only for normal steady operating modes but also for start-up, shut-down and for recovery from maloperations. The operating conditions are such that the plant stays well within safe boundaries of operation and that substantial safety margins are maintained. Some safety arguments are wholly deterministic in nature.

7.5 Where extreme fault combinations result in the operating conditions deviating outside the safe operating regime then probabilistic risk assessment (PRA) has been employed.

The PRA techniques adopted are designed for two main purposes:-

- i. The identification of potential hazard scenarios (ie single event or combinations of events leading to a hazard).
- ii. The estimation of the frequency or likelihood of the identified hazard scenarios.

7.6 The available hazard identification and analysis techniques fall into two main categories - 'interpolative' techniques such as Fault Tree Analysis (FTA) and 'extrapolative' techniques such as Failure Modes and Effects Analysis (FMEA) and Event Tree Analysis (ETA). HAZOP studies and professional assessment combine aspects of both techniques.

Interpolative techniques consider the "ultimate hazard", and identify the potential faults which could cause this hazard. Extrapolative techniques consider the initiating faults (or types of

fault) and identify the potential hazards which could result. The approach adopted on THORP is a combination of extrapolative and interpolative techniques designed to exploit the advantages of each.

7.7 Having identified potentially significant hazardous conditions, the frequency of the hazard has been estimated using Fault Tree Analysis (FTA). FTA is considered to be the most effective technique for the evaluation of hazard rates. Fault Tree Analysis has therefore been used extensively in the THORP safety analysis to estimate frequencies of hazards and scrutinise sequence logic and sensitivities.

7.8 A Fault and Protection System Schedule has been generated which brings together the interpolative and extrapolative methods applied in PRA, and the hazard identification process. The result is a systematic consideration of the potential causes of identified hazards, coupled with a quantified estimate of the hazard consequences and frequency. The schedule catalogues the PRA cases put forward for THORP. In addition the production of the schedule has constituted a further assessment of the process.

7.9 The safety analysis is supported by a reliability data base and a consequence data base. A system of justification and use ensures that each use of the data from the data bases is recorded and its particular application justified. In addition human error data has been generated in a consistent fashion and its application justified and recorded.

7.10 Using 'interpolative' and/or 'extrapolative' techniques the hazard frequency of the identified hazards have been evaluated. Using the consequence data base, or specific mathematical modelling, the discharge of radiological significant isotopes to the environment are determined. The environmental models established for Sellafield, to consider acute release of activity, have been used to evaluate the time averaged dose/risk to critical group members of the public. Similarly using hazard frequency data the annual risk to the workforce on the plant has been determined. The summed time averaged annual risk or summed hazard frequency for the critical group or workforce has been generated and compared with the adopted criteria. Where it has been indicated during the evolution of the design that criteria may be breached or ALARP consideration determine, the safety assessors and design engineers have acted either to reduce the frequency of potential hazards or taken design steps to reduce further the consequence.

## 8. MAJOR HAZARDS IDENTIFIED

8.1 The five complementary approaches detailed in Section 6.1, for the identification of hazards, cumulatively represent an extensive and comprehensive approach to the examination of THORP. These methods have identified the following events as potential hazards in some or all of the THORP plant areas:-

- Criticality
- Fires/Explosions
- Loss of Containment
- Impact Damage
- Abnormal Discharge
- Extreme External Hazards

In addition, certain generic failures/hazard causes have been included in safety case hazard analyses. The most notable examples are Control and Human Factors.

8.2 These hazards have been rigorously analysed in plant areas and for plant processes where they have been identified as occurring. The resulting derived frequencies for the hazards have been evaluated, with the consequence of the hazard, to contribute to the time averaged annual risk (workforce and critical group).

## 9. ASSESSED RISK (FAULT CONDITIONS)

By employing the safety methodology outlined in Section 3 to the identified hazards, the risk to the public and workforce from that hazard on THORP has been deduced. Further, the summed risk/frequency of events are evaluated across THORP. Table I and II give typical examples of some of the assessed risks from specific hazards. Assessments are undertaken only to that level needed to demonstrate satisfying limiting criteria. Pessimisms remain within the analyses, that allow reductions in the assessed risk to be demonstrated if necessary.

## 10. SENSITIVITY

Throughout the safety analysis the derived hazard frequencies and consequence analysis has been subjected to sensitivity analyses. This has been done to establish the major elements of an event sequence contributing to the event frequency or to determine the factors are the major elements within a consequence analysis. By identifying these elements be they hardware, human interventions or common cause failure, the sensitivity of the results to changes data in those elements has been evaluated. Further, such analysis is taken further when the Safety Case analysis (fault trees) are rigorously examined prior to plant commissioning. During the production of the THORP's Operational Safety Assessment further sensitivity analysis will be carried out to identify where the plant may need operating rules or additional safety mechanisms.

## 11. THE DIMENSIONS OF THE PLANT AND SAFETY CASE

The £1500M investment in THORP Head End and Chemical Separation Plant has been reflected in the magnitude of the civil engineering, the mechanical and electrical installation, a comprehensive research and development programme and extensive expenditure on safety analysis. To bring the Plant to an operational status has required excellence in Project Management with a supporting level of excellence from the contributing management teams, analysts and engineering disciplines. To put some perspective on the project, Table III gives an overview of the engineering dimensions of the THORP plant. Table IV gives an overview of the extent and current cost, to date, of the safety analysis on the Project. In each case the expenditure in resources and funds is given for the period 1983-1991.

## 12. CONCLUSIONS

12.1 THORP, as a second generation nuclear fuel reprocessing plant, is a comprehensive facility. It is designed to take whole irradiated fuel elements and to process them to produce a uranium product, a plutonium product, and effectively manage its solid, liquid and aerial wastes. Physically THORP is a large structure and at the forefront of nuclear technology, and it is technically sophisticated.

12.2 During its design and construction the radiological safety implications of the plant and its processes have been rigorously examined by accepted safety methodology. Indeed the most advanced techniques available for safety assessment and evaluation have been employed. This has led to the evolution of a facility engineered to meet the design safety standards and principles with some margin. The outcome of the safety case has demonstrated that the plant will meet, for both normal operation (Table I) and identified fault sequences (Table II), the Plant's safety criteria. The Plant, through its safety analysis, demonstrably presents an acceptable annual risk to the workforce and the public within the scope of its proposed fuel specification and throughput.

12.3 Finally, throughout the safety analysis full cognizance of the requirements of the regulatory authorities and government ministries has been taken. Exchanges of information with these bodies has been carried out to ensure that the adopted criteria encompasses and meets agreed requirements.



Table I Normal Operations - Assessed Risk Against  
Primary Risk Criteria for THORP

Criteria	% Usage (1)	Comment
<u>General Public</u>		
Critical Group Dose from aerial releases < 50 uSv.y <sup>-1</sup>	50	(25 uSv.y <sup>-1</sup> ) equates to a risk of death of < 10 <sup>-6</sup> y <sup>-1</sup>
Critical Group Dose from liquid release < 50 uSv.y <sup>-1</sup>	50	(25 uSv.y <sup>-1</sup> ) equates to a risk of death of < 10 <sup>-6</sup> y <sup>-1</sup>
<u>Workforce</u>		
Average external whole body dose per worker 5 mSv y <sup>-1</sup>	70	Estimated range 2.0 - 5.3 mSv y <sup>-1</sup> Simple average taken to indicate approximate % usage
Maximum individual dose (internal plus external) 15 mSv y <sup>-1</sup>	50	Maximum is for Head End Mechanical Maintenance Engineers

(1) Rounded numbers

Table II Potential Fault Conditions - Assessed Risk  
Against Primary Risk Criteria for THORP

Criteria	THORP Allocation (1)	% Usage (2)	Comment
<u>General Public</u>			
Time averaged CEDE (3) to the Critical Group (Sv. y <sup>-1</sup> )	4 x 10 <sup>-6</sup> (4)	19	Equates to a risk of death of approximately 1 x 10 <sup>-8</sup> y <sup>-1</sup>
Accumulated frequency (y <sup>-1</sup> ) of events giving a consequence greater than 100 mSv to the Critical Group	4 x 10 <sup>-6</sup> (4)	0.3	Equates to a risk of death of << 1 x 10 <sup>-9</sup> y <sup>-1</sup>
The frequency (y <sup>-1</sup> ) of an individual event giving a short term consequence of greater than 100 mSv at 3 km from Plant	< 10 <sup>-6</sup>	0	
<u>Workforce</u>			
Building evacuating - Contamination	4 x 10 <sup>-2</sup>	19	
- High dose rating frequency (y <sup>-1</sup> )	4 x 10 <sup>-2</sup>	11	
High dose > 100 mSv frequency (y <sup>-1</sup> )	4 x 10 <sup>-4</sup>	22	Equates to a risk of death of < 1 x 10 <sup>-9</sup> y <sup>-1</sup>
Prompt death frequency (y <sup>-1</sup> )	< 10 <sup>-6</sup>	0	

(1) Allocation of the Sellafield site criteria

(2) Rounded numbers

(3) Committed Effective Dose Equivalent

(4) Includes a factor for averaging over wind direction

Table III Overview of the Engineering Dimensions of THORP

Key Quantities

General

Concrete poured	190,000 m <sup>3</sup>
Reinforcing	40,000 t
Main Frame Steelwork	19,000 t
Stainless Steel Pipework	234,000 m
Carbon Steel Pipework	82,000 m
Major Vessels	3,000
Minor Vessels and Plant Items	11,500
Ventilation Ducting	42,000 m
Electrical and Instrument Cabling	3,000,000 m
Sub Stations and Switch Boards	45
Main Computers	15
Zonal Computers	90

Building

Building Approximate Size	260m x 120m x 48m
Chimney Height	120 m
Room Spaces	2,032
Building Cladding	58,000 m <sup>2</sup>
Stainless Steel Cladding	23,000 m <sup>2</sup>
Construction Personnel (typically)	3,500

Table IV Overview of the Safety Analysis Dimension of THORP

OVERALL DIMENSIONS

- Total Effort Expanded 1983-1992	~ 160 (1) (2) man years
- Total Real Time Expanded	~ 9 years
- Cost of the Theoretical Safety Analysis and Documentation	~ £8M <sup>(1)</sup>

SAFETY ANALYSIS BREAKDOWN

- Total Effect Expanded 1983-1991	~ 160 man years
- Committees	2%
- HAZOPS	10%
- Regulatory Issues	19%
- Assessment and documentation	69%
- Safety Working Party Papers and Technical Assessment Notes	> 600

HAZARD AND OPERABILITY STUDIES

- Effort expanded	~ 16 man years
- Number of Design Drawing Studies	> 1000
- Actions Placed	> 8000

NOTES

(1) Is for safety assessment only. Excludes technical and engineering costs supporting safety. Would increase the figure to about a factor of 2.

(2) Estimated total to commissioning 1992 is 180 man years.

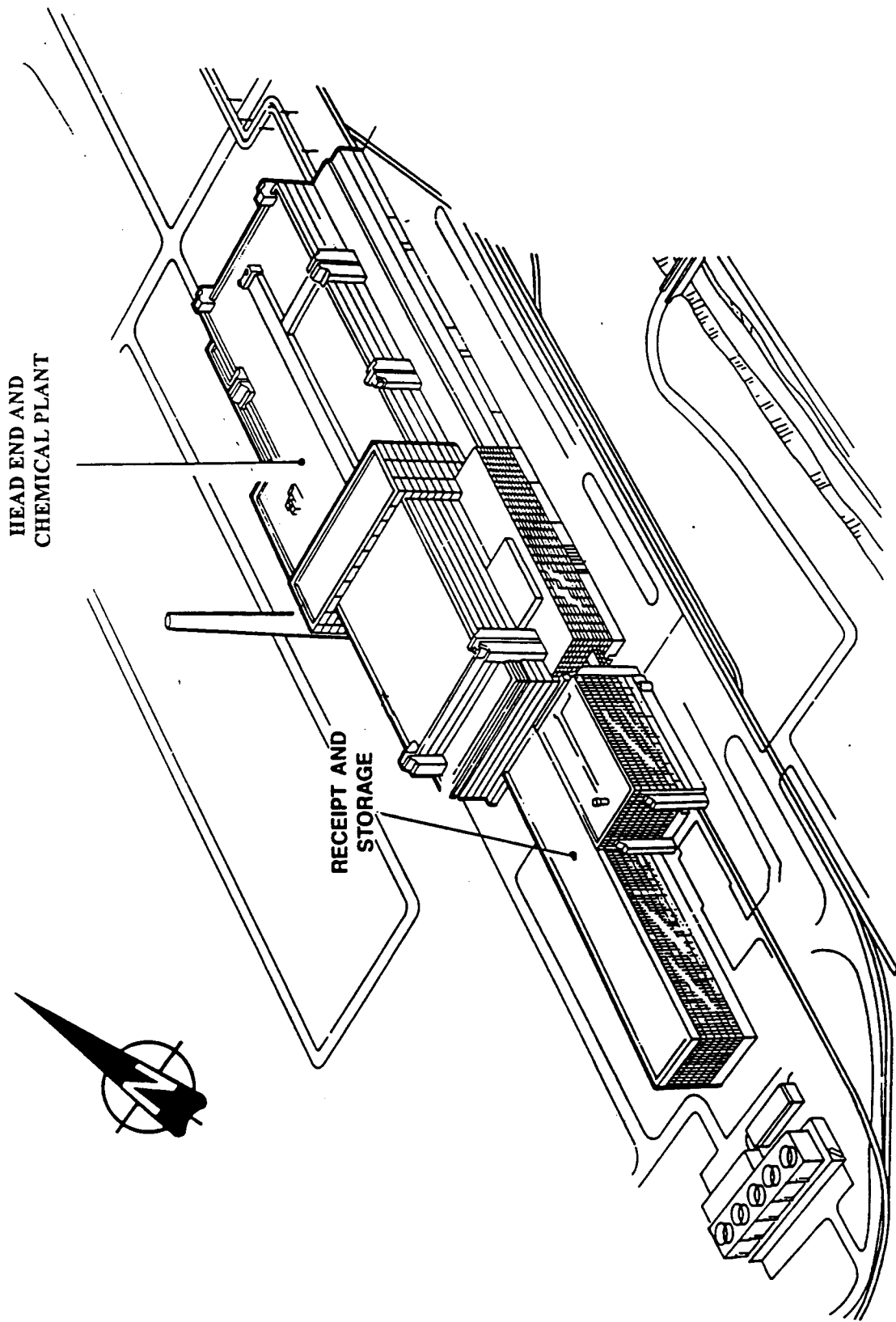

FIGURE 1: MAIN THORP BUILDING - ISOMETRIC

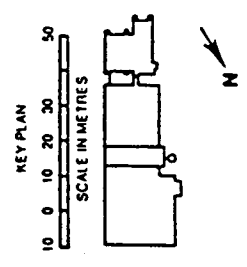
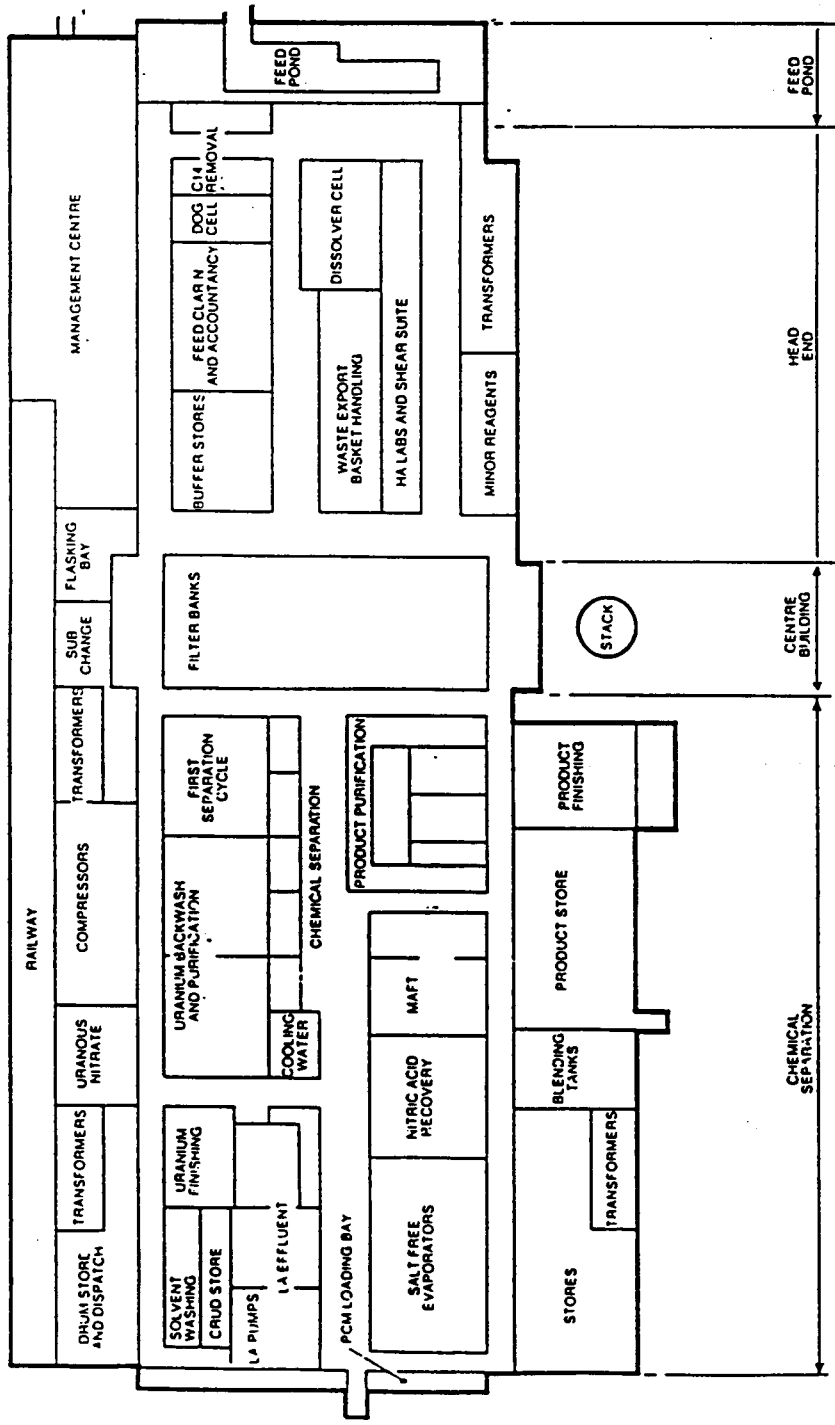

FIGURE 2: THORP HEAD END AND CHEMICAL SEPARATION PLANT—SCHEMATIC

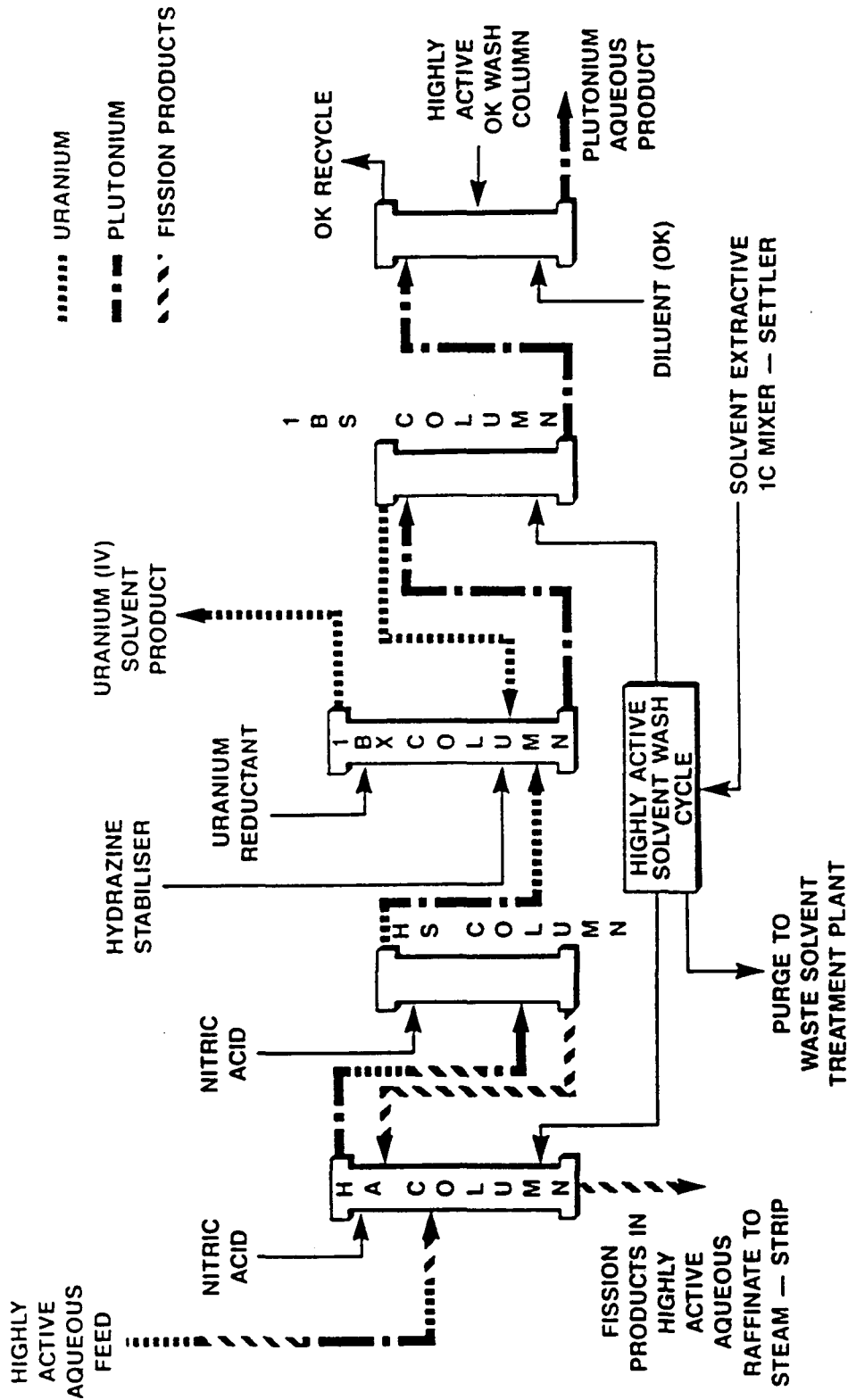

FIGURE 3: PRIMARY SEPARATION OF URANIUM, PLUTONIUM AND FISSION PRODUCTS

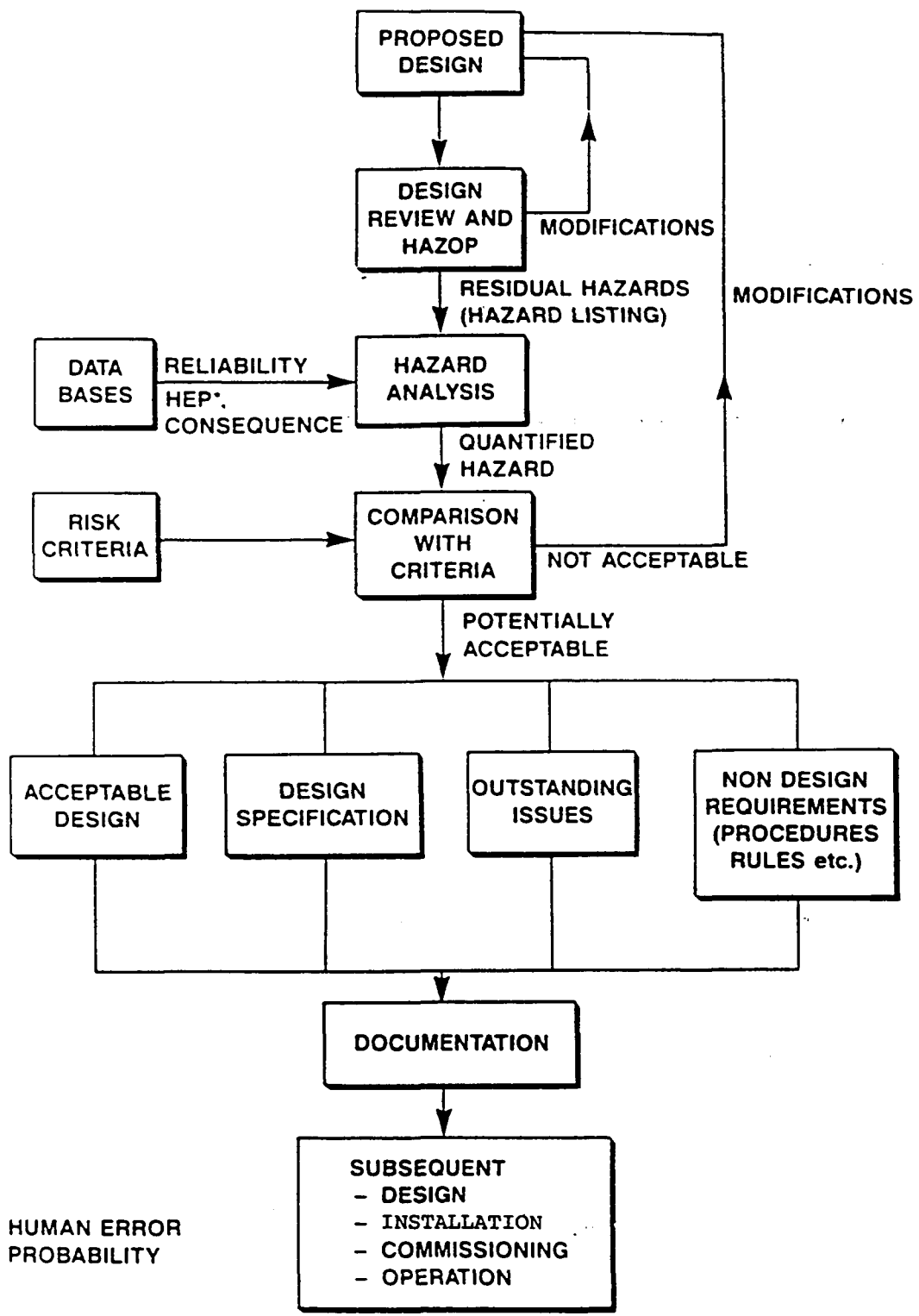

FIGURE 4: SCHEMATIC FLOW DIAGRAM FOR SAFETY METHODOLOGY



# HAZARD ANALYSIS

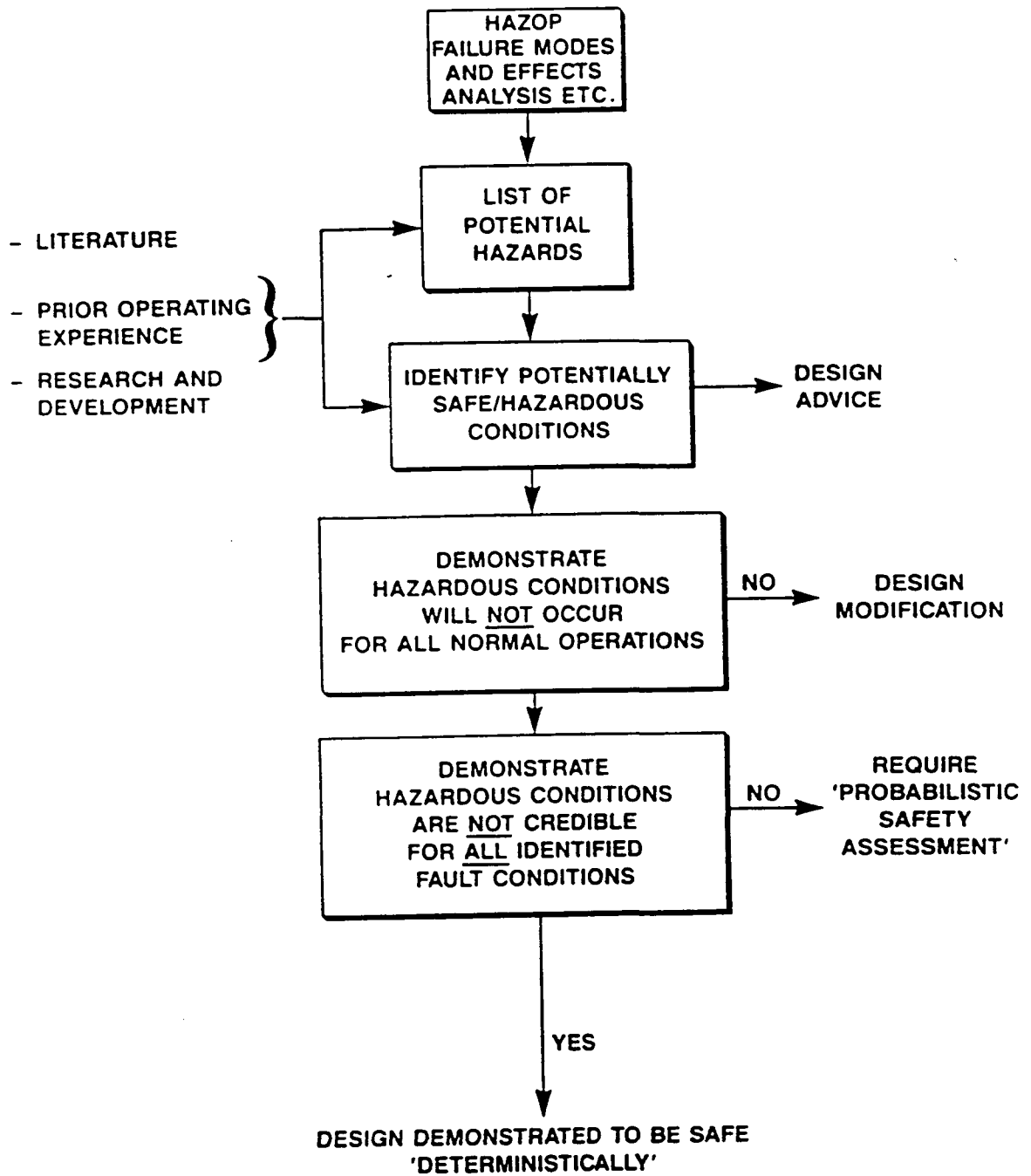

FIGURE 5: DETERMINISTIC APPROACH

# HAZARD ANALYSIS

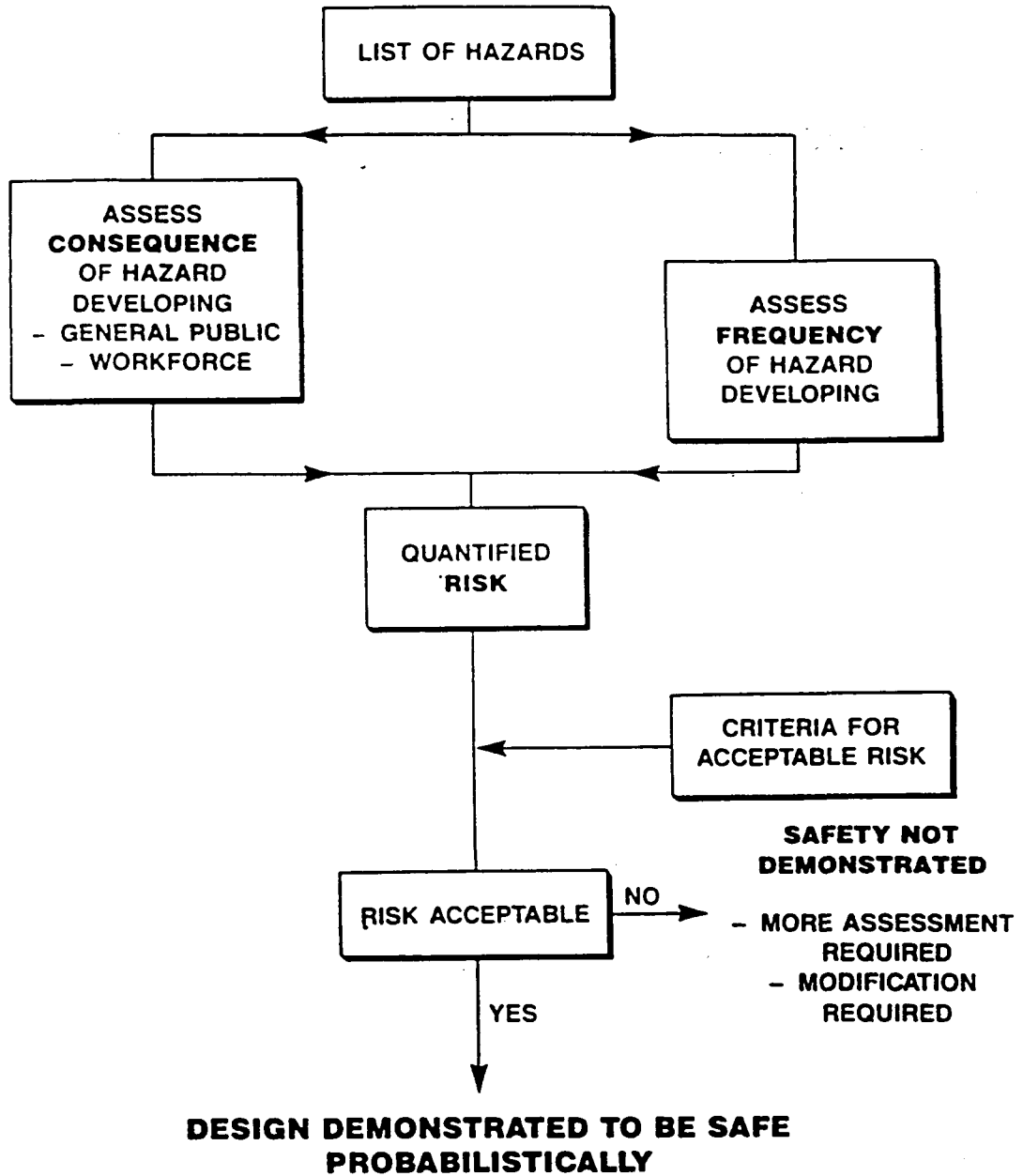

FIGURE 6: PROBABILISTIC SAFETY ASSESSMENT APPROACH

BNS/OECD-NEA Symposium on the SAFETY OF THE NUCLEAR FUEL CYCLE  
BRUSSELS, 3-4 JUNE 1993

THE SAFETY ASSESSMENT OF PLANT MODIFICATIONS AND DECOMMISSIONING ON THE BNFL  
SELLAFIELD SITE

W C Mullineaux, Safety Assessor, BNFL

Abstract

A wide variety of plant modifications are currently being carried out on the Sellafield Site. To assure plant safety and satisfy the Nuclear Site Licence Conditions it is necessary to assess modifications with regard to their impact on plant safety cases and to ensure that the Company safety criteria are met. The HAZOP study of all aspects of modifications is seen as an important part of these assessments.

Resume

L'experience courante a sellafield inclue une grande variete de modifications aux usines en marche. Pour assurer la securite des usines et satisfaire le permit nucleaire d'operations a Sellafield, il est necessaire d'evaluer les modifications a l'egard de leur effet sur la documentation de securite pour chacune des usines et pour que la Compagnie s'assure que les criteres de securite soient satisfaites. L'etude HAZOP sur tous les details de modifications joue un role important dans ces evaluations.

1 INTRODUCTION

- 1.1 The Sellafield Site of British Nuclear Fuels is essentially an integrated plant for the handling, storage and reprocessing of irradiated nuclear fuel. Its prime function at present is to receive and treat approximately 1000 tonnes per annum of 'Magnarox' fuel arising from reactors in the UK and abroad, and to receive and store irradiated uranium oxide fuels.
- 1.2 On the Sellafield Site there is currently a significant on-going programme of decommissioning and modifications aimed towards improving the safety, the technical, and commercial performance of the plant. Decommissioning is treated as a category of modification and demands the same level of safety assessment as operational plant. Modification of plant is well known throughout industry to be an activity which, if not carefully managed, can lead to serious failures with damaging safety and commercial consequences. In particular, temporary modifications, often maintenance related, can increase the vulnerability of a plant.
- 1.3 The concern of the modifications safety assessments is to identify radiological hazards, contributory causes, consequences, and frequency, and to demonstrate that all aspects satisfy the appropriate criteria. HAZOP studies, which are an integral part of most safety assessments, have proved beneficial in a wider sense, leading to improvements in the project engineering and planning. They have also been applied with success to the procedures associated with the installation method.

## 2 CONTROL OF MODIFICATIONS

2.1 A modification is defined as a change to processes or equipment which in any way alters the plant or its mode of operation. It is important that modifications are carefully controlled and at Sellafield a comprehensive authorisation and safety assessment system is in place to enable the Company to demonstrate that safety implications have been addressed and the requirements of the Nuclear Site Licence have been met. The document central to the control of modifications and their safety assessment is the Plant Modifications Proposal (PMP). This document requires a safety categorisation of the modification to be made, and if there are implications for radiological safety, an assessment which normally includes HAZOP studies and Probabilistic Safety Analysis has to be carried out. Clearly, in the situation where only finite resources are available, and where a large number of 'non-radiological' modifications proposals are in hand, it is not practicable to carry out HAZOP studies in every case. In some instances HAZOP studies at the preliminary stage of a project have been used as part of the safety categorisation process.

## 3 SAFETY ASSESSMENT STRATEGY

- 3.1 The principal concern of a modifications safety case is the quantified assessment of radiological hazards due to fault conditions, ie Probabilistic Safety Analysis (PSA). Safety cases also include quantified assessments of planned exposure to radiation, and qualitative statements on non-radiological hazards, eg fire and industrial safety.
- 3.2 Sellafield's safety criteria for accidental radiation exposure are based on the concept of individual risk (time averaged annual probability of fatality), developed for both the public and workforce. The first step in their application is identification of foreseeable potential hazards and causes - usually achieved by hazard and operability studies. It may be possible at this stage to demonstrate by deterministic methods that the plant is intrinsically safeguarded against some of the hazards. The second step is quantification of the identified hazards in terms of their likely consequences and expected frequencies. The chosen technique for quantification is PSA. The third and final step is comparison of the PSA results with the numerical criteria. This also allows identification of operational practices and items of equipment which are particularly important in avoiding the faults concerned or their adverse consequences. These are then declared respectively as Operating Rules (ORs) and Safety Mechanisms (SMs) to draw attention to their importance, in line with Sellafield's Nuclear Site Licence.
- 3.3 To simplify the assessment task, it is necessary to treat families of similar or related potential hazards as one event. Bounding cases are selected for assessment. These and other approximations are made subject to the requirement that the overall assessment be broadly pessimistic. It is not required that every step in every assessment be incontrovertibly pessimistic: the multiplicative nature of these assessments would have made this approach valueless. Assessments are initially approached with a simple, often highly pessimistic model. If criteria are met with a significant margin, this is the model that appears in the final PSA. If criteria are

met (or are only just met), the model is divided and refined until either the criteria are met, or the assessor concludes he cannot show that they are met, in which case the modification proposal is re-examined. This process has on occasion resulted in cost savings and re-consideration of proposals.

- 3.4 BNFL Sellafield is committed to completing a programme of fully developed Safety Cases for every plant on site, Reference 1. Once a safety case has been published, it is kept up to date with any major plant or process modifications at the time of their implementation. In addition, it is reviewed annually and re-assessed regularly, usually every 5 to 8 years depending on hazard potential. Modifications are incorporated, and the safety case is updated using the current safety assessment methodology and data.

#### 4 HAZOP METHODOLOGY

- 4.1 The modification HAZOP studies are carried out essentially as described by T A Kletz in Reference 2. The guidewords generically used throughout the field of HAZOP studies have been customised by BNFL to suit the particular needs of a nuclear chemical plant. The guidewords and examples of their 'expansion' for process related modifications are shown in Table 1. This table is principally applied to the HAZOP study of changes to continuous processes. The HAZOP studies of changes to sequential operations, and mechanical systems (frequently involving handling operations), are based on the guidewords and applications shown in Table 2. The list of issues can never be totally exhaustive, but those shown in the table provide a useful trigger for lateral thinking. The guidewords in Table 2 are used for HAZOP studies of 'method statements' used for the installation of modifications. The applications list is used as the basis for modifications design HAZOP I studies directed to reviewing and improving the design rather than searching for hazards.
- 4.2 During HAZOP study meetings it is an established BNFL routine to raise formal actions on individuals to ensure that the issues identified during the study are satisfactorily followed up. Actions can be of the following types: information seeking, confirmation of data/design feature, confirmation of plant status, design changes, method changes and changes to Operators Instructions. The proceedings of the HAZOP meetings are recorded in full detail, including all actions placed, this record is then used as the nucleus of a HAZOP report. This document is the means whereby the appropriate information is passed on to the analyst for any required probabilistic assessment.
- 4.3 It is the practice at Sellafield for the HAZOP studies to be led by an independent chairman, ie someone not connected with the project and therefore unaffected by financial and programme pressures. This chairman or leader is taken from the Safety Assessment Department and reports to a line management separated from project, design or operations. In this way, it is considered that the HAZOP study can be more thorough with less difficulties in the placing of actions, the avoidance of pressure arising from interdepartmental politics and the elimination of unnecessary embellishment of the plant.

## 5 TYPES OF MODIFICATION

The types of modification can be categorised as follows:

- 5.1 Decommissioning and dismantling of old and redundant nuclear plant, including post operation clean out. Paradoxically this frequently requires extensive refurbishment of the facilities in order to handle significant quantities of radioactive materials whilst complying with modern dose uptake and safety standards.
- 5.2 Refurbishment - principally required in order to continue the operation of plant approaching the end of its design life (but can be an essential part of decommissioning).
- 5.3 Plant Improvements - aimed towards improving safety, reducing maintenance load, reducing dose uptake, reducing effluent discharges (in volume and levels of radioactivity), increasing profitability, throughput and capacity.
- 5.4 Change of Use - there are considerable advantages to be gained both in terms of safety and cost in maximising the use of existing facilities and converting them to satisfy entirely new functions.
- 5.5 Research and Development - existing operational facilities are often used as the vehicle for investigation of improvements or new techniques. It is important to establish that such work does not compromise safety.

## CASE STUDIES

Two major projects are described which serve to demonstrate the BNFL approach to modifications safety assessment.

### 6 DECOMMISSIONING AND DISMANTLING THE 'WINDSCALE PILE CHIMNEYS'

- 6.1 The skyline of the Sellafield Site is dominated by the two massive concrete chimneys 125m high which are the cooling air outlet ducts for the original Windscale reactors, now shut down and largely defuelled. Structural surveys on the two chimneys reveal significant deterioration of steelwork within the upper sections requiring their removal on a short timescale.
- 6.2 The general objective of the modification is to convert the two chimneys from complex structures to simple concrete shafts. It is proposed to achieve this by the removal of the upper structure including the internal insulation lining of the main shaft. Due to the 'Windscale Reactor Fire' of 1957, levels of radioactive contamination limit the use of manual contact methods, and remote handling techniques are therefore necessary to control dose uptake.
- 6.3 A pair of telerobotic arms remotely controlled from ground level are being used to remove the contaminated glass fibre lining, Figure 1. The design concept for the robotics and the method statement for their deployment were subjected to a HAZOP study. The principal hazards are the release of contaminated airborne particulate, the probability of major impact forces arising from dropped loads, and reduced structural integrity.

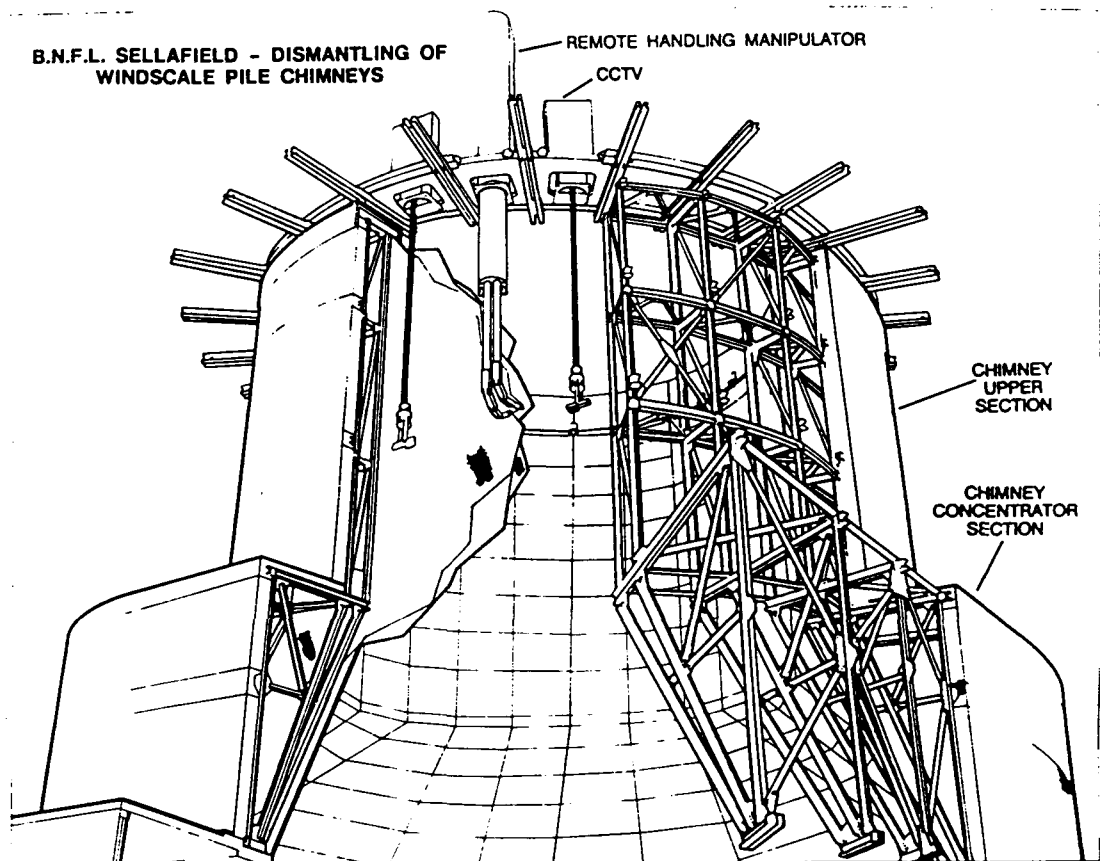

FIGURE 1

- 6.4 Contributory causes of airborne release identified at HAZOP are: loss of the ventilation extract system intended to maintain a depression in the chimney lining cavity, and the penetration of the containment boundary by dropped loads (eg the telerobotic arm or concrete blocks cut from the structure).
- 6.5 The installation of cross connections on each side of the duplicated filtration banks was identified as an improvement for increasing both the operational flexibility and the availability of the ventilation system. The need to adequately protect the telerobotic equipment from lightning strike and to ensure that it was capable of withstanding oscillations arising from the buffeting of severe gales were identified as important design requirements.
- 6.6 Following the identification of hazards and contributory causes, it was possible to carry out a probabilistic safety assessment and determine whether or not the safety criteria in terms of consequence and frequency were satisfied. This particular safety case was complicated by the close proximity of the pile chimneys to the old shut down nuclear reactors, these containing a significant inventory of irradiated fuel.
- 6.7 Although the radiological and 'chemical' hazards arising from the decommissioning of radioactive plant are the same as for most operational plant, ie release of activity in a variety of forms, the contributory causes can be significantly different.

## 6.8 Typical contributory causes of hazards in decommissioning are:

- intentional disruption of containment boundaries, ie ducting, pipework, vessels, cells;
- removal of shielding in order to gain access;
- generation of dusts from cutting and demolition type activities;
- reduced structural integrity, corrosion and general deterioration;
- increased opportunity for operator error when using telerobotic or remote handling methods;
- debris entering operational systems, eg ventilation ducts;
- unexpected inventories of activity;
- operator error resulting in removal of wrong pipework or incorrect position of access;
- old plant not designed to modern standards of containment;

## 7 REFURBISHMENT OF THE DISSOLVER VESSEL IN THE MAGNOX REPROCESSING PLANT

7.1 The dissolution of decanned fuel is a vital step in the reprocessing of Magnox fuel. Due to high corrosion rates it has been necessary to replace the original dissolver with a new unit of the same design which will be brought on line during the next two years. During dissolver refurbishment the opportunity will be taken for implementing other plant improvements.

7.2 The preparation of the safety case for this major undertaking on an ageing radioactive chemical plant involved 103 HAZOP meetings during which 32 hazard initiating events and 88 operability problems were identified. The basic hazards associated with a refurbishment project of this type are the same as those found in any radiochemical plant, ie direct radiation exposure of the workforce and the release of radioactive material in liquid, solid or gaseous form. The HAZOP studies concentrated on the differences between the original plant design and changes associated with the refurbishment.

7.3 Generally when refurbishment does not result in any change to the plant design, HAZOP studies would be used only to assess procedural aspects of removing and installing equipment. Connection of the existing highly active pipework to the replacement dissolver will require the use of telerobotic methods. A potential hazard is the release of active liquors from in-cell pipework and the transfer of these liquors via the robotic arm to occupied areas of plant. This accidental release could be caused by misdirection of the robotic arm whilst manipulating cutting tools, with subsequent damage to liquor filled pipes. Such a fault could be initiated by human error or failure of the control system. This scenario was considered during a HAZOP study and will be subject to PSA as part of the Refurbishment Safety Case.

## 8 SUMMARY

This paper has outlined the BNFL approach to the safety assessment of modifications projects, and the role of HAZOP studies. Experience from HAZOP meetings and subsequent feedback shows that the safety assessments produce benefits additional to satisfying Licensing Requirements. These benefits may be summarised as follows:



- a) design, operability and safety improvements are often achieved, mainly at a minor detailed level, but frequently the result of the study is confirmation that the project has been adequately conceived and planned; and consequently overall levels of confidence are increased;
- b) the detail and logic of procedures, Operators Instructions and method statements are frequently improved;
- c) staff concerned with the project, but representing different disciplines and departments are brought together in an 'impartial atmosphere' and feel free to express any reservations they might have without prejudice;
- d) in some cases it is the first time that design engineers have had 'face to face' discussion with representatives from other areas, for example, industrial safety or health physics sections;
- e) staff admit that their overall knowledge of the project is often improved considerably by attendance at HAZOP meetings;
- f) the completeness and adequacy of any proposed development work or inactive test programmes can be confirmed and often improved;
- g) the HAZOP team leader because of his contact with modifications and projects site-wide is able to assist in the cross fertilisation of ideas from one project team to another.

#### REFERENCES

- 1 HM Nuclear Installations Inspectorate, Safety Audit of BNFL Sellafield, 1986, HMSO 1986.
- 2 Kletz T A, HAZOP and HAZAN, Notes on the Identification and Assessment of Hazards, IChemE, Hazard Workshop Module, 2nd Edition, 1982.

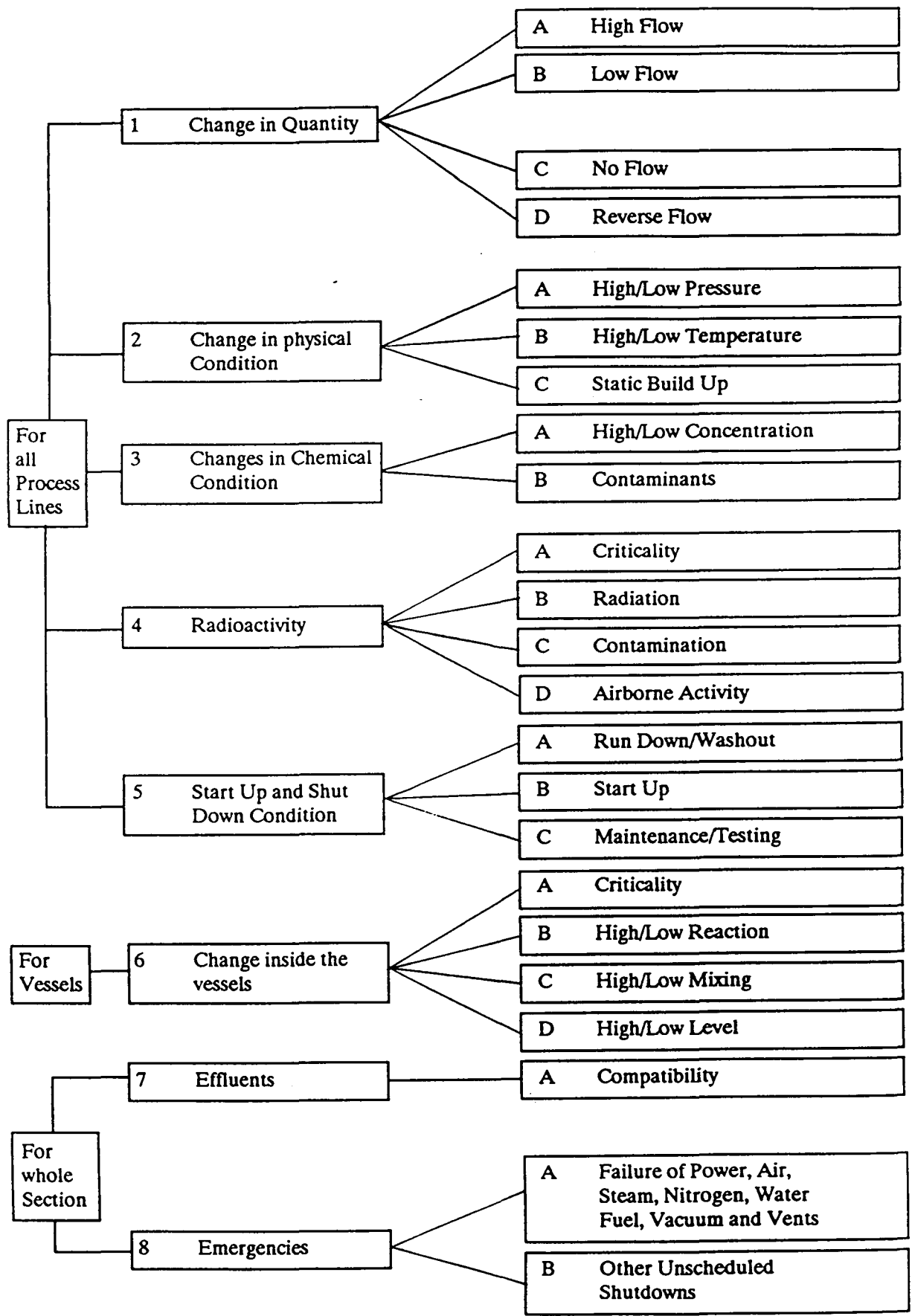

TABLE 1 : HAZOP GUIDEWORDS FOR CONTINUOUS PROCESS OPERATIONS

WORD	SENSE	APPLICATION		
		PROCESS/RADIOLOGICAL	MECHANICAL	
NO NOT	None Total absence Not at all Never Nothing Total loss of ... Not provided Omitted	Flow Leakage Seepage Draining Empty Full Pressure Temperature Radiation Contamination Containment Criticality Shielding Fire Ventilation Testing Services	Dose Uptake Alternative Recording Measuring QA External dose Internal dose Control Wastes disposal Design life	Strength Guarding Supports Maintenance Survey Recovery Corrosion Quality control Stability Lighting Inertia Viewing Distortion Shear Creep Expansion Contraction Force Hardness Softness Centre of G Weight Seismic Velocity Acceleration Impact Handling Lifting
MORE	Greater Too much Too many Too big			
LESS	Insufficient Too little Too few Inadequate			
AS WELL AS	At the same time In addition Synchronism Knock-on effect Simultaneous - (unrelated) events	Effect of nearby plant or processes (normal or failure) Loss of services Nearby accidents - fire, explosion, leakage Extreme weather and other external events Emergencies in other buildings		Missile damage and external events

TABLE 2 : HAZOP GUIDEWORDS FOR SEQUENTIAL OPERATIONS AND HAZOP I APPLICATIONS

Table 2

WORD	SENSE	APPLICATION	
		PROCESS/RADIOLOGICAL	MECHANICAL
PART OF	Incomplete Interrupted Discontinued Intermittent	Process operations	Mechanical movements or procedures
REVERSE	Opposite to the intention Wrong direction	See above listing Decommissioning Flow	Mechanical movements
OTHER THAN	Completely different Wrong	See above listing Ease of operator error Control panel/room ergonomics	Ease of operator error Control system
SOONER	Too early Wrong time	Process operations Programming	Timing Synchronism
LATER	Too late Wrong time	As above	As above

## The Vitrification of High-Level Wastes in France: from the Lab to Industrial Plants

Claude G. SOMBRET

*Commissariat à l'Energie Atomique - France*

### Abstract

Research in the area of vitrifying concentrated fission product solutions began in France in the 1950s. Vitrification processes were developed along with suitable materials, notably borosilicate glasses. The primary objective of glass investigations is to determine and assess the alteration phenomena that occur during ultimate storage in a geological repository. With the development of glass fabrication processes, a continuous vitrification technique has been implemented in three vitrification units, associated with the three French reprocessing plants; the units were commissioned in 1978, 1989 and 1992.

### Résumé

*Les recherches effectuées en France sur la vitrification des solutions concentrées de produits de fission ont débuté dans les années 50. Parallèlement à la mise au point des matériaux, des verres de type borosilicate, des procédés de vitrification ont été développés. Les études sur le verre sont principalement consacrées à la détermination des phénomènes d'altération intervenant au cours de leur stockage définitif en milieu géologique. Le développement des procédés de fabrication des verres a permis de mettre en oeuvre une technique de vitrification continue dans trois ateliers de vitrification associés aux trois usines de retraitement. L'exploitation en actif de ces trois ateliers a commencé en 1978, 1989 et 1992.*

## 1. Historical Background

Research on solidifying concentrated fission product solutions began in France in 1957. Investigations were initially conducted simultaneously in two areas: vitrification and conversion to synthetic minerals, notably micas. Although promising results were obtained in synthesizing phlogopites (potassium-bearing micas)<sup>[1]</sup>, it soon became apparent that such minerals were unsuitable for incorporating not only all the radionuclides but also the wide range of nonradioactive elements found in highly variable quantities in concentrated fission product solutions.

By the early 1960s, work therefore focused on glass, and especially on borosilicates and aluminoborosilicates capable of solidifying various types of high-level waste solutions produced by the three French reprocessing plants. Important progress was made in determining glass compositions, characterizing their properties and assessing their long-term behavior<sup>[2-27]</sup>. A vitrification process involving prior gelation was developed as early as 1958 to obtain glass blocks for investigation. The process was implemented in the *Vulcain* cells built first at Saclay, then at Fontenay-aux-Roses<sup>[28]</sup>. A gel process facility known as GULLIVER subsequently began operating at Marcoule in 1963 to produce radioactive glass blocks ranging from 5 to 15 kg with specific activity levels of about  $4 \times 10^{13}$  Bq per liter of glass.

The limited size of the gel fabrication process equipment made it difficult to ensure an exhaustive investigation of the off-gas treatment and glass storage facilities. An industrial pilot facility was therefore built on line with the Marcoule reprocessing plant (UPI) to produce large glass blocks with high specific activity<sup>[3,6]</sup>. The facility, known as PIVER, implemented a pot vitrification process. Built between 1965 and 1968, PIVER was operated continuously from 1969 to 1973 to solidify solutions from reprocessed natural uranium fuel from French gas-cooled reactors, and later in 1979 and 1980 to demonstrate process compatibility with the higher burnup of reprocessed fuel from the PHENIX fast breeder reactor. In all, some 13.5 metric tons of borosilicate glass were fabricated from 32 m<sup>3</sup> of concentrated fission product solutions, containing over 18.5 × 10<sup>16</sup> Bq and with specific activities of up to 15 × 10<sup>13</sup> Bq per liter of glass.

PIVER was operated with no serious problems throughout the active demonstration periods, substantiating vitrification as a containment method for high-level wastes. No difficulties were encountered with the interim storage facility, which was the basis for designing similar facilities for the subsequent industrial units. The batch vitrification process implemented in PIVER yielded vital information concerning off-gas treatment and radioactive glass storage but, from an industrial standpoint, was unable to handle annual solidification requirements exceeding about 25 to 30 m<sup>3</sup> of fission product solutions. Another method with a higher throughput was therefore designed concurrently, based on a two-step process in which calcining was followed by melting in an induction-heated metal melter. The first plant implementing this process, AVM, was built at Marcoule from 1974 to 1977, and began active operation in 1978. Two other units were commissioned at La Hague in 1989 (R7) and 1992 (T7).

## 2. Glass

The glass compositions were determined according to a number of criteria, including compatibility with the elements in the feed solutions, industrial feasibility, significant volume reduction factors, and suitable behavior in interim storage and after final disposal. The elements in the feed solutions depend mainly on the following factors: the nature of the fuel, the fuel cladding material, the nature and effectiveness of the decladding procedure, the fuel burnup, the nature of the process reagents, the efficiency of the U and Pu separation process, the presence of any neutron poisons, the final solution concentration, the existence of a treatment following concentration, and the age of the solutions. As a result, borosilicate glasses with different compositions were developed for the vitrification of solutions at Marcoule and La Hague.

Industrial feasibility covers properties such as viscosity at process temperatures, melter resistance to corrosion by the molten glass, and volatilization of some elements during fabrication. Interim storage behavior is affected mainly by the glass resistance to thermal shocks and to devitrification (thermal stability). Long-term disposal behavior depends also on thermal stability, as well as on the containment properties with respect to the long half-life radionuclides under realistic disposal conditions (with allowance for the geological environment, temperature, pressure, leaching fluid composition and leaching mode) and alpha self-irradiation effects.

Table I indicates the basic composition and properties of typical glasses fabricated in the AVM.

Table I. Characteristics of Some UPI Glass Compositions

Properties	Waste Type		
	Defense	MTR	Defense + Commercial
Composition (wt%)			
SiO <sub>2</sub>	38.1	37.0	38.4
Na <sub>2</sub> O	17.8	19.4	17.1
B <sub>2</sub> O <sub>3</sub>	16.4	15.4	17.3
Al <sub>2</sub> O <sub>3</sub>	12.3	23.2	11.0
Fe <sub>2</sub> O <sub>3</sub>	4.2	1.7	3.2
MgO	4.1	-	5.1
NiO + Cr <sub>2</sub> O <sub>3</sub>	1.0	0.2	0.8
F	2.0	1.8	1.5
Fission product and actinide oxides	4.0	1.3	5.6
Typical liquid/solid volume reduction factor	7.0	3.5	6.0
Approx. glass volume (dm <sup>3</sup> ) per ton of fuel	8	3400	10
Viscosity (dPa) at 1100°C	150	430	130
Thermal conductivity (W·K <sup>-1</sup> ·m <sup>-1</sup> ) at 100°C	1.25	1.25	1.25

The leach rates for mixed defense and commercial glass are roughly as follows:

- $5-6 \times 10^{-4} \text{ g}\cdot\text{cm}^{-2}\cdot\text{d}^{-1}$  for boron under Soxhlet conditions at  $100^\circ\text{C}$ ;
- $2-3 \times 10^{-6} \text{ g}\cdot\text{cm}^{-2}\cdot\text{d}^{-1}$  for cesium at room temperature during semidynamic testing using industrial grade water;
- $4 \times 10^{-4} \text{ g}\cdot\text{cm}^{-2}$  normalized boron mass loss after static leaching for 28 days at  $90^\circ\text{C}$  with a glass-surface-area-to-solution-volume (SA/V) ratio of  $50 \text{ m}^{-1}$ .

The required glass properties at La Hague are basically the same as at Marcoule, but with a significant difference: the burnup of the La Hague fuel is higher, and the fission product oxide content must therefore be on the order of 11 wt% to obtain the specified volume reduction factor of 110 liters of glass per metric ton of fuel. This results in a higher specific heat than at AVM, and requires a longer interim cooling time (the solutions are vitrified about one year after reprocessing). The glass composition is indicated in Table II, and some physical properties of the glass are noted in Table III.

Glass homogeneity is assessed by visual examination, chemical analysis, optical microscopy and scanning electron microscopy with X-ray and microprobe analysis. The glass is homogeneous, and only rare chromite crystals are observed. However, a minimum process temperature is required to avoid the formation of a molybdenum-rich phase.

Thermal stability is assessed by inducing crystallization through heat treatment for 15 to 20 hours at temperatures ranging from  $590$  to  $1160^\circ\text{C}$ . After examination and analysis, five crystalline phases (only one of which has been formally identified) have been observed between  $610$  and  $1160^\circ\text{C}$ : calcium molybdate or powellite ( $\text{CaMoO}_4$ ), a silicate complex (Si, Ca, Fe, Ni, Cr), a mixed oxide (Ce, U, Th), a chromite (Cr, Fe, Ni, Zn) and a Cr-Ni phase. Nevertheless, the total glass crystallization does not exceed 1 vol%. This result is unaffected by longer heat treatment (100 hours at  $780^\circ\text{C}$ , the minimum crystallization temperature), indicating good thermal stability.

Soxhlet mode dynamic leach tests at  $100^\circ\text{C}$  show leach rates of  $2$  to  $4 \times 10^{-4} \text{ g}\cdot\text{cm}^{-2}\cdot\text{d}^{-1}$  for most of the glass structure elements. The overall radionuclide release rate by leaching with industrial grade water is  $1.5 \times 10^{-7} \text{ g}\cdot\text{cm}^{-2}\cdot\text{d}^{-1}$  for  $\alpha$ -emitters and  $1.0 \times 10^{-7} \text{ g}\cdot\text{cm}^{-2}\cdot\text{d}^{-1}$  for  $\beta$ -emitters after 40 days.

Glass investigations to date have been conducted with nonradioactive materials, with highly radioactive materials (1–2 kg glass blocks containing several hundred curies), or using doped glass samples ( $^{242}\text{Cm}$ ,  $^{241}\text{Am}$ ,  $^{237}\text{Np}$ ). A major effort is now in progress to determine the groundwater corrosion mechanisms for a variety of realistic disposal scenarios.

### 3. Industrial Vitrification Process: Principles

The operating principle has been described on several occasions in the literature<sup>[28-32]</sup>.

Calcining is performed in a metal tube rotating at about 30 rpm and heated by an electrical resistance furnace. The tube is inclined 3% from the horizontal. The feed solution is supplied at the top of the tube through a leaktight coupling. Calcinate exits from the bottom of the tube via a leaktight duct in which it is mixed with borosilicate glass frit. The bottom fitting leads to the glass melter immediately below (Figure 1). A loose metal bar inside the tube prevents scale accumulation on the calciner wall. The calcining furnace includes four independent heating zones to establish a temperature gradient along the

Table II. Nominal Composition of R7 Glass (wt%)

SiO <sub>2</sub>	45.1	P <sub>2</sub> O <sub>5</sub>	0.3
B <sub>2</sub> O <sub>3</sub>	13.9	Li <sub>2</sub> O	2.0
Al <sub>2</sub> O <sub>3</sub>	4.9	ZnO	2.5
Na <sub>2</sub> O	9.8	ZrO <sub>2</sub>	1.0
CaO	4.0	Dissolver sludge	0.7
Fe <sub>2</sub> O <sub>3</sub>	2.9	Actinide oxides	0.9
NiO	0.4	Fission product oxides	11.1
Cr <sub>2</sub> O <sub>3</sub>	0.5		

Table III. R7 Glass Characteristics

Specific gravity	2.75
Viscosity at $1100^\circ\text{C}$	$8.8 \text{ N}\cdot\text{m}^{-2}\cdot\text{s}^{-1}$
Linear expansion coefficient ( $25-300^\circ\text{C}$ )	$8.3 \times 10^{-6} \text{ K}^{-1}$
Young's modulus	$8.4 \times 10^{10} \text{ N}\cdot\text{m}^{-2}$
K <sub>1</sub> C stress intensity factor	$0.9 \text{ MN}\cdot\text{m}^{-3/2}$
Thermal conductivity at $25^\circ\text{C}$	$1.1 \text{ W}\cdot\text{m}^{-1}\cdot\text{K}^{-1}$

tube. The maximum temperature reached in the calciner is about 600°C. The resulting calcinate is a mixture of oxides and nitrates; the nitrate decomposition rate depends on the initial solution composition.

The calcinate and frit drop simultaneously into the melter, a metal pot heated to about 1180°C by a medium-frequency inductor. The feed products fall into a molten glass bath and enter into reaction, while the nitrates are decomposed. When the molten glass reaches a specified level, the glass is cast by gravity through a nozzle at the bottom of the vessel sealed by a cold glass plug that is melted by an induction heater. The nozzle includes a siphon so casting stops naturally and melter containment integrity is maintained. Calcinate and frit continue to be fed to the melter during casting.

The off-gas stream is removed from the calciner and the upper coupling, and processed by a suitable treatment facility.

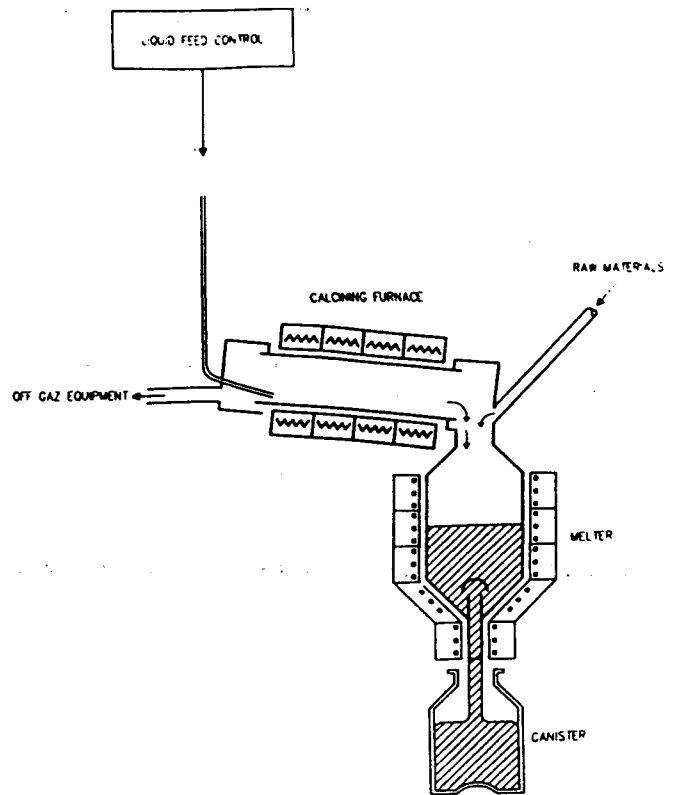

Figure 1. The French Industrial Vitrification Process

#### 4. The Marcoule Vitrification Facility (AVM)

The UPl reprocessing plant operated by COGEMA at Marcoule began operation in 1958. It reprocesses spent fuel from plutonium production reactors as well as from commercial natural uranium gas-cooled reactors and the Material Testing Reactor (MTR). The plant uses the Purex process, generating highly radioactive wastes in the form of acid fission product solutions which are stored on the site in stainless steel tanks. Some solution characteristics are indicated in Table IV. Note that fluorine is present in the solutions, and that MTR solutions also contain very large quantities of aluminum.

Table IV. Characteristics of UPl Fission Product Solutions

Reactor System	MTR	GCR (Defense)	GCR (Commercial)
Fuel Type	UAl-PuAl	Sicral	Sicral
Burnup (MWd·t <sup>-1</sup> )	500 000	1000	4000
Concentration (dm <sup>3</sup> ·t <sup>-1</sup> )	12 000	30	100
Specific activity after 2 years of cooling (Bq·dm <sup>-3</sup> )	low	2-4 × 10 <sup>13</sup>	6 × 10 <sup>13</sup>
Specific power (W·dm <sup>-3</sup> ) after 2 years of cooling	low	2-3	4-5
Acidity (M)	-1.8 (depleted)	1.5-2.0	1.0-1.5
Composition (g·dm <sup>-3</sup> )			
Al	81	30-35	10-12
Na	2-3	19-23	2-5
Mg	-	4	3
Fe	1-2	15-17	8
Ni	-	1-2	1
Cr	-	1-2	1
F	10-12	8	5
Fission products and actinides	low	22-27	37-42

Some solution characteristics are indicated in Table IV. Note that fluorine is present in the solutions, and that MTR solutions also contain very large quantities of aluminum.

The Marcoule Vitrification Facility (AVM)



was specially designed and built to solidify these solutions. The facility has been described on many occasions in the literature<sup>[29-35]</sup> and only the main features will be reviewed here.

AVM consists primarily of a partially underground reinforced concrete structure 20 m long, 18 m wide, 19 m high above ground and 14 m below ground level. An adjoining building houses offices and a truck loading bay. The main building comprises a narrow central cell surrounded by ancillary rooms and cells. The central vitrification cell contains the main process equipment: calciner, melter, feed system, dust recycling system and condenser. It also houses equipment for automatic welding of the glass canister lids and is designed to permit remote dismantling of all equipment, as well as maintenance and quick replacement of all consumable items, particularly mechanical parts.

The calciner is a tubular forging made of Uranus 65 alloy (French standard Z 2 CNNB 25-20) 12 mm thick with an outside diameter of 272 mm, measuring 3.25 m long, including a heated zone 2.50 m long. The end fittings include mechanical disconnect provisions and slide back on rails. The cross-shaped descaling bar is nearly as long as the calciner tube. The four-zone electric kiln comprises eight mechanically separate elements: four lower half-shells and four upper half-shells, all of which may be remotely dismantled for replacement or to allow access to the calciner. Each heating zone is delimited by a pair of upper and lower half-shells.

The melter is an Inconel 601 alloy vessel 1 meter high and 10 cm thick with an inside diameter of 350 mm. The heating system consists of a stack of three 10 kHz induction coils embedded in cement and placed concentrically around the melter: one for the cylindrical portion of the vessel, one for the tapered portion and one for the casting nozzle. The total heating power is 100 kW. The melter and its refractory casing are physically separate from the inductors, to allow replacement of the latter without affecting the melter.

The solution from the liquid storage tanks is transferred to two 10 m<sup>3</sup> buffer tanks, which are cooled and mechanically stirred. The solution is sampled for analysis, and is chemically adjusted as necessary to comply with the raw material composition. A double airlift then transfers the solution to the metering unit in the vitrification cell, which supplies the calciner at a rate of 30–36 l·h<sup>-1</sup> depending on the liquid concentration. An organic chemical additive (*Ferupore*<sup>TM</sup> azodicarbonamide) is also introduced at a rate of 2 l·h<sup>-1</sup> to prevent caking on the calciner wall and descaling bar, and to improve the calcinate size distribution. Solution from the off-gas scrubber is also recycled at a rate of 4 l·h<sup>-1</sup>. Calcinate is produced at a rate of between 8 and 11 kg·h<sup>-1</sup>, partly in powder form, partly as granules. The calcinate still contains a fraction of the nitrates from the feed solution. The calciner kiln is rated at 70 kW (25 kW for both of the drying zones, and 10 kW for each of the two denitration and calcination zones). The actual power consumption is only about 40–45 kW.

Glass frit is supplied to the melter at a mean rate of 9–12 kg·h<sup>-1</sup> in 400–600 g batches through a lock. A variable voltage can be applied to each melter induction coil; the voltage depends on the glass level, determined by monitoring the temperature at several points. The available power rating is 100 kW, although the actual consumption is only 60 kW.

Casting is initiated every 8 hours by heating the cold glass plug in the casting nozzle: 120 kg of molten glass at 1100–1150°C are then cast into a refractory stainless steel canister 50 cm in diameter and 1 m high, which accommodates three melts; the glass weight is determined during casting. At the end of each casting operation, a portion of the glass is trapped in the tapered lower portion of the melter by the siphon. The throughput is therefore about 15 kg of glass per hour, yielding one canister containing 360 kg (150 l) of glass every day. One canister contains the equivalent of some 800 liters of fission product solution.

A few hours after filling, the canister is transferred to the welding station where a lid is welded on using a plasma torch. The canister is externally decontaminated one day later by placing it in a tank and washing the surface with high pressure (200 bar) water using an annular sprayer moving from top to bottom. The decontamination efficiency is checked by injecting air around the canister and monitoring for airborne contamination. The canister is submitted to additional wipe testing and counting when it is transferred to the storage pit.

Process gases from the calciner and melter consist of steam, nitrogen compounds due to denitration, and particle matter, most of which is soluble in nitric acid. The first step in the off-gas treatment therefore involves counter-current scrubbing in a dust separator; the spent liquid is continuously recycled back to the calciner. The off-gas stream then flows through a condenser to a standard treatment system comprising a scrubbing column, an absolute filter and a blower to ensure the desired negative system pressure.

Process liquid wastes are handled differently according to their specific activity. The condensate and spent liquids from the first column are considered as high-level wastes and are recycled back to the fission product solution concentration facility for vitrification. Spent liquids from the scrubbing column and canister decontamination stations (about 500 l per day) contain less than  $1 \text{ mCi}\cdot\text{m}^{-3}$  and are therefore transferred to the low-level waste treatment facility; these are the only liquid wastes released from AVM.

The glass storage facility near the vitrification cell is designed to ensure compliance with safety requirements at low operating cost, and to allow subsequent retrieval of waste canisters. The canisters are externally decontaminated to avoid filtration requirements when natural convection cooling is substituted for forced-air cooling after a suitable interim storage period. The facility comprises three engineered concrete vaults lined with a leaktight stainless steel barrier. Canisters measuring one meter high are stacked ten deep in vertical underground shafts extending beneath the top slab. Two of the vaults include 80 shafts each, with 60 more in the third vault. The total surface area of the vaults is  $415 \text{ m}^2$  and additional space is available for future extensions.

The ventilation system was designed to prevent the forced air temperature from exceeding  $100^\circ\text{C}$  at the maximum glass specific power level; this limits the concrete temperature to  $60^\circ\text{C}$  and the glass core temperature to  $500^\circ\text{C}$  with forced-air cooling, or  $600^\circ\text{C}$  with natural convection. Safety is ensured in the event of a blower failure by redundant blowers and backup power generators. Even if the cooling system failed completely, the heat capacity of the storage facility would allow permissible temperatures to be maintained for at least three hours throughout the facility, i.e.  $60^\circ\text{C}$  in the concrete structures and  $650^\circ\text{C}$  in the glass.

The mean lifetime of a melting pot is approximately 3000 hours, although the current lifetime is significantly higher, and some pots have been used for over 6000 hours.

AVM is still operated 24 hours a day, with only three persons per normal shift. It is now used only to vitrify solutions produced in routine operation at UP1 (the backlog accumulated since 1978 has been eliminated). Both the process and the facility itself have demonstrated high safety levels for workers and for the environment. The occupational dose for the operating personnel is virtually nil, and the cumulative dose sustained by the maintenance staff during exceptional maintenance operations is only a few tens of  $\text{mSv}$ <sup>[36]</sup>. Gaseous releases account for about 30 MBq per year, a small fraction of the permissible limit for the site. Some 7 TBq of liquid wastes are supplied each year to the Marcoule liquid waste treatment station.

AVM began active operation in 1978. As of February 1993, approximately  $1640 \text{ m}^3$  of concentrated fission product solutions with a total activity of some  $13 \times 10^{18} \text{ Bq}$  had been solidified in about 733 metric tons of glass contained in 2076 canisters.

## 5. The La Hague Vitrification Facilities (AVH)

A second fuel reprocessing plant, UP2, was commissioned in 1966 at La Hague, in Normandy, and is operated by COGEMA. Although initially designed only to reprocess spent fuel from commercial gas-cooled reactors, it was completed in 1976 by a "high-activity oxide" (HAO) head-end facility to accommodate LWR fuel. The rated capacity of the HAO extension is about 400 metric tons per year. In order to meet French and foreign throughput requirements, the plant capacity was increased to  $800 \text{ t}\cdot\text{y}^{-1}$  and another identical plant, UP3, was built on the same site. UP3 began operating in 1990, and the refurbished UP2 plant is scheduled to go on stream in 1994. Two virtually identical vitrification facilities<sup>[37]</sup> operated by COGEMA were also built at La Hague: "R7" for UP2, and "T7" for UP3.

The Purex process used in UP1 at Marcoule is also implemented in the La Hague reprocessing plants, which generate highly radioactive acid solutions that are stored in stainless steel tanks. The concentrated fission product solutions are vitrified together with solutions containing dissolver sludge and alkaline solutions from solvent regeneration and evaporator rinses. The theoretical composition of these solutions is indicated in Table V, based on a nominal fuel burnup of  $33\,000 \text{ MWd}\cdot\text{t}^{-1}$  and for reprocessing after three years of cooling.

Additives are supplied to the feed tank before vitrification to adjust the solution to the nominal composition. They include 28 l of  $\text{HNO}_3$  per ton of uranium and 2.5 kg of aluminum per ton of uranium in the form of  $\text{Al}(\text{NO}_3)_3$ . The burnup of the La Hague fuel is considerably higher than for the fuel reprocessed at Marcoule, and the ruthenium content of the solutions is therefore higher. Sugar (20 g per liter of final solution) is added to the feed stream to prevent volatilization during fabrication.

Table V. Composition and Characteristics of Solutions Vitrified in R7 (in grams per ton of initial uranium)

	Conc. FP solutions	Dissolver sludge	Alkaline solutions
Volume (liters)	300	135	198
Na			9 700
HNO <sub>3</sub>	38 000		
U	713	93	648
Pu	50	5	3 000
Am	325		
Np	433		
Cm	25		
Fission products	26 000	3 000*	
Fe	6 000		
P	364		
Ni	958		
Cr	1 018		
Zircaloy particles		1 000	
βγ activity	1940 × 10 <sup>13</sup> Bq	120 × 10 <sup>13</sup> Bq	100 × 10 <sup>10</sup> Bq
α activity	10 × 10 <sup>13</sup> Bq	7 × 10 <sup>10</sup> Bq	4 × 10 <sup>10</sup> Bq
*including 37.0% Ru, 34.6% Mo, 13.2% Pd, 8.4% Tc and 6.6% Rh			

The process implemented in the R7 and T7 facilities is based on the same principle as at AVM, but the throughput capacity was augmented to meet production requirements corresponding to 2 × 800 tons of reprocessed fuel per annum. The two principal components, the calciner and the melter, were scaled up accordingly. The facility includes three vitrification lines, two of which are used in normal operation with the third on standby. To enhance the availability of each unit, the three lines are functionally independent for radioactive solution input and adjustment, calciner feeding, calcination, glass production and off-gas treatment. Auxiliary systems with field-proven reliability are common to all three lines to cut capital costs. Other design differences from the

earlier AVM facility include the use of sugar (also substituted for azodicarbonamide); layout changes, including the location of the canister lid welding and inspection stations, based on AVM experience; maintenance technologies and control system architecture, based on new developments for the recent UP2 and UP3 reprocessing plants.

Unlike AVM, each line includes a vitrification cell containing only the calciner, the melter, the off-gas scrubber and condenser. The other radioactive cells shared by all three lines include a fission product storage cell, a NO<sub>x</sub> absorption cell, a glass casting cell, a canister cooling, welding and preliminary monitoring cell, a decontamination cell, a second monitoring cell and a dismantling cell. The process equipment, control room and offices are housed in a building measuring 52 × 61 × 43 m.

The tubular kiln was directly extrapolated from the AVM geometry: the heated length was increased from 2.5 to 3 m, and the inside diameter from 250 to 300 mm; the electric power rating was increased to 90 kW. The same materials (Uranus 65) are used for the descaling bar and kiln. A metering wheel supplies the three feed streams to the calciner.

As in AVM, the melter comprises two removable elements: a metal pot and a heating system. The Inconel 601 alloy pot has an oval cross section and includes internal fins. The flat bottom includes two outlets: a glass casting nozzle and a total drain port. The casting nozzle includes a siphon designed to retain approximately 40 liters of molten glass in the pot. The heating system includes four inductors for the pot itself together with two casting inductors, operating at 4 kHz with a total power rating of 200 kW.

In each fabrication line, concentrated fission product solutions are transferred to two mechanically stirred 20 m<sup>3</sup> tanks, which also receive alkaline rinse solutions from 10 m<sup>3</sup> tanks. The solutions are chemically adjusted as necessary and are routinely sampled for analysis. The solutions are then fed by a 41.3 l·h<sup>-1</sup> metering wheel to a buffer tank above the calciner. The buffer tank also receives the recycled output from the gas scrubber (6 l·h<sup>-1</sup>), and dissolver sludge suspensions from a 3 m<sup>3</sup> tank via a 9.7 l·h<sup>-1</sup> metering wheel (the suspensions can also be transferred to the 20 m<sup>3</sup> tanks). The solution from the buffer tank and a sugar solution (3 l·h<sup>-1</sup>) are supplied to a manifold leading to the upper end of the calciner.

Solid glass frit is added via a double-sealed metering system through the calciner lower coupling in uniform batches to maintain a constant flow rate of 16.8 kg·h<sup>-1</sup>. After refining at 1150°C, the glass is cast at 8-hour intervals by heating the freeze valve. Some 200 kg of glass are cast at a rate of about 200 kg·h<sup>-1</sup>; the overall mean throughput is thus 25 kg·h<sup>-1</sup>. Each refractory stainless steel canister is 1335 mm high, 430 mm in outside diameter and 5 mm thick, accommodating two melts, or 400 kg. The canister is weighed during casting. Its concave bottom is designed to facilitate stacking in the storage facility.

The glass casting cell contains 3 casting stations. Each comprises an elevating table to lift the canister beneath the melter casting nozzle and lower it again after filling, a turntable, and a lid installation machine.

The cooling/welding/monitoring cell receives the canister fitted with its lid. After a suitable cooling period, the plasma torch welding machine welds the lid onto the canister. The canister is then checked for external contamination by a robot arm with a swab: the entire outer surface of the canister is wiped, and the activity is measured in a chamber. If no contamination is detected, the canister is transferred in a lead cask to the interim glass storage facility; otherwise it is sent to the decontamination cell.

The decontamination cell contains two mobile tanks, one for glass canisters and the other for solid waste containers. Decontamination is performed inside the tanks with water or acid at a pressure of about 250 bars.

The second monitoring cell contains a robot identical to the one in the first monitoring cell. If the contamination does not exceed  $3.7 \times 10^4$  Bq·m<sup>-2</sup>, the canister is transferred in a lead cask to the interim glass storage facility; otherwise it is returned to the decontamination cell.

The NO<sub>x</sub> absorption cell contains an absorption column and a safety column. The gas stream is ducted across HEPA filters before reaching the discharge stack.

The dismantling cell receives solid engineering wastes produced during component replacement and maintenance operations.

All vitrification operations are executed under automatic control. All transfers inside and between active cells are automatically remote-controlled from the extensively computerized control room.

The simple design of AVM was adopted for R7 and T7, but with increased cooling capacity: canisters containing 400 kg of glass have a unit thermal power of 2.5 to 3 kW, and the glass core temperature must not exceed 510°C. Nine canisters are stacked in each storage shaft.

As of March 1993, the R7 vitrification facility had produced 1592 canisters containing 625 metric tons of glass from 1420 m<sup>3</sup> of concentrated fission product solutions with a total activity of  $20.5 \times 10^{18}$  Bq. The initial fission product solutions solidified in R7 differed slightly from the composition indicated above: they were produced by reprocessing fuel with a burnup of 23 000 MWd·t<sup>-1</sup>, cooled for 5 to 15 years before reprocessing. The off-gas treatment has demonstrated its design efficiency: the decontamination factors measured in each line have been approximately  $1.5 \times 10^6$  for <sup>106</sup>Ru and  $1 \times 10^6$  for <sup>137</sup>Cs. The R7 facility is operated in five shifts with a total staff of about 90 persons, including administrative and technical personnel but not the laboratory analysts.

As of March 1993, the T7 vitrification facility had produced 286 canisters containing 114 metric tons of glass from 239 m<sup>3</sup> of concentrated fission product solutions from foreign fuel reprocessed in UP3, with a total activity of  $4.6 \times 10^{18}$  Bq.

## 6. Outlook

The three French reprocessing plants are each served by a vitrification facility of suitable capacity. Although UP1 at Marcoule, and thus AVM, are already scheduled for shutdown in the near future, the UP2/R7 and UP3/T7 complexes will continue to operate for many years.

Although the world's reprocessing capacity is inadequate for the stock of irradiated fuel, it would be premature to consider the construction of another plant at this time. The reprocessing plants at Sellafield (UK) and later at Rokkashomura (Japan) will help to meet the demand, and reprocessing is far from being a universally accepted solution.

Nevertheless, if the demand were to increase, a vitrification process with still higher capacity has been developed<sup>[26]</sup>. In this process, induced currents are created in the glass by a high frequency solenoid inductor surrounding a crucible consisting of an assembly of metal tubes separated by a thin electrically insulating layer. The glass is preheated by a microwave system to a temperature at which it becomes an acceptable conductor (0.01–0.5 Ω·m). A nonradioactive prototype unit has been in operation at Marcoule for several years. The melter comprises a stainless steel cold crucible 550 mm in diameter, capable of containing 300 kg of molten glass. The inductor surrounding the crucible is supplied by a triode generator operating at frequencies between 150 and 500 kHz. The generator is powerful enough to allow glass melting at temperatures well above 1400°C.

The melter is supplied continuously with a mixture of calcinate and glass frit, and is easily capable of melting 50 kg·h<sup>-1</sup>. Glass is cast in 200 kg batches at 4-hour intervals. The melt is supported by a water-

cooled metal hearth through which extend two metal casting nozzles. The glass plug in each nozzle is melted by a small induction heater, allowing the glass to be cast into a canister beneath the melter. On startup, microwave power is supplied to the cold glass by a 25 kW generator operating at a frequency of 915 MHz. It is connected to the melter head by a stainless steel waveguide through a gas-tight quartz window that is transparent to microwaves.

## References

1. R. BONNIAUD, P. COHEN and C. SOMBRET, *Attempts to Incorporate Concentrated Fission Product Solutions in Glasses and Micas*, Second International UN Symposium, Geneva (1958).
2. R. BONNIAUD, C. SOMBRET and F. LAUDE, *Vitrification of Concentrated Fission Product Solutions: Studies and Characteristics of Glasses*, IAEA Symposium on Treatment and Storage of High-Level Radioactive Wastes, Vienna (1962).
3. R. BONNIAUD, F. LAUDE and C. SOMBRET, *Experience Obtained in France in Vitrification Treatment of High-Level Fission Product Solutions*, OECD Conference on Management of Radioactive Wastes, Paris (1972).
4. R. BONNIAUD, F. PACAUD and C. SOMBRET, "Quelques aspects du comportement de radioéléments confinés à long terme sous forme de verre ou de produits à forte phase vitreuse", *Verres et Réfractaires* 29, No 1 (Jan-Feb 1975).
5. R. BONNIAUD and C. SOMBRET, *Statement of Research in the Field of Solidification of High-Level Radioactive Wastes in France*, 77th Annual Meeting of the American Ceramic Society, Washington DC, (1975).
6. C. SOMBRET, R. BONNIAUD and A. JOUAN, *High-Level Waste Management in France*, AIF Workshop on the Management of Spent Fuel and Radioactive Wastes, Washington DC (1979).
7. E. VERNAZ, P. DEYMIER and N. JACQUET-FRANCILLON, *Mechanical Properties of Some Candidate Glasses for High-Level Radioactive Waste Management*, Second International Symposium on Ceramics in Nuclear Waste Management, 85th Annual Meeting of the American Ceramic Society, Chicago (1983).
8. J.L. NOGUES and A. TERKI, *Influence du mode de lixiviation sur l'altérabilité d'un verre de confinement de produits de fission*, Congrès sur "Le Verre et l'Eau", Brussels (1984).
9. J.L. NOGUES, E. VERNAZ and N. JACQUET-FRANCILLON, *Nuclear Glass Corrosion Mechanisms Applied to the French LWR Reference Glass*, MRS Annual Meeting: 8th Symposium on the Scientific Basis for Nuclear Waste Management, Boston (1984).
10. J.L. NOGUES, E. VERNAZ, N. JACQUET-FRANCILLON and S. PASQUINI, *Alterability of the French LWR Solution Reference Glass in Repository Conditions*, MRS Annual Meeting: 8th Symposium on the Scientific Basis for Nuclear Waste Management, Boston (1984).
11. C. SOMBRET, "The Vitrification of High-Level Radioactive Wastes in France", *Nuclear Energy*, 24, No 2, pp. 85-98 (April 1985).
12. J.L. NOGUES, E. VERNAZ, N. JACQUET-FRANCILLON and S. PASQUINI, "Interaction between a Nuclear Glass and Nearfield Materials", *Proceedings of the International Seminar on Radioactive Waste Products*, Jülich, Germany (1985) pp. 470-482.
13. S. FILLET, E. VERNAZ, J.L. NOGUES and N. JACQUET-FRANCILLON, *Corrosion Rate of Nuclear Glass in Saturated Media*, Third International Symposium on Nuclear Waste Management, 88th Annual Meeting of the American Ceramic Society, Chicago (1986).
14. E. VERNAZ, J.L. DUSSOSSOY and S. FILLET, *Temperature Dependence of R7T7 Nuclear Waste Glass Alteration Mechanisms*, MRS Annual Meeting: 11th International Symposium on the Scientific Basis for Nuclear Waste Management, Boston (1987), editors M. APTED and R. WESTERMAN.
15. A. JOUAN, A. TERKI, F. PACAUD and J.P. MONCOUYOUX, "Research and Development Status of the French Vitrification Process", *Proceedings of the International Conference on Nuclear Fuel Reprocessing and Waste Management (RECOD '87)*, Paris (1987), p. 669.
16. J. MAILLET and C. SOMBRET, *High-Level Waste Vitrification: The State of the Art in France*, Waste Management '88, Tucson (1988).
17. F. PACAUD, N. JACQUET-FRANCILLON, A. TERKI and S. FILLET, "R7T7 LWR Waste Reference Glass Sensitivity to Variations in Chemical Composition and Operating Parameters", MRS Annual Meeting: 12th International Symposium on the Scientific Basis for Nuclear Waste Management, Berlin (1988), editors R. EWING and W. LUTZE.

18. N. GODON, E. VERNAZ, J.H. THOMASSIN and J.C. TOURAY, "Effect of Environmental Materials on Aqueous Corrosion of R7T7 Glass", MRS Annual Meeting: 12th International Symposium on the Scientific Basis for Nuclear Waste Management, Berlin (1988), editors R. Ewing and W. Lutze.
19. E. VERNAZ, T. ADVOCAT and J.L. DUSSOSSOY, "Effects of the SA/V Ratio on the Long-Term Corrosion Kinetics of R7T7 Glass", Fourth International Symposium on Nuclear Waste Management, 91st Annual Meeting of the American Ceramic Society, Indianapolis (1989).
20. T. ADVOCAT, *Les mécanismes de corrosion en phase aqueuse du verre nucléaire R7T7: Approche Expérimentale - Essai de modélisation thermodynamique et cinétique*, PhD Thesis (1991).
21. N. JACQUET-FRANCILLON, "Les verres de confinement des déchets nucléaires", *Verre* 5, No 1, pp. 9-21 (Jan-Feb 1991).
22. N. GODON and E. VERNAZ, *R7T7 Nuclear Waste Glass Alteration in Geological Repository Media*, Joint International Waste Management Conference, Seoul, Korea (1991).
23. E. VERNAZ and J.L. DUSSOSSOY, "Current State of Knowledge of Nuclear Waste Glass Corrosion Mechanisms: the Case of R7T7 Glass", *Applied Geochemistry* Special Issue No 1, pp. 13-22 (1992).
24. F. PACAUD, C. FILLET and N. JACQUET-FRANCILLON, *Effect of Platinoids on French LWR Reference Glass Properties*, MRS Annual Meeting: 15th International Symposium on the Scientific Basis for Nuclear Waste Management, Strasbourg (1991), editor C. SOMBRET.
25. E. VERNAZ and N. GODON, *Leaching of Actinides from Nuclear Waste Glass: French Experience*, MRS Annual Meeting: 15th International Symposium on the Scientific Basis for Nuclear Waste Management, Strasbourg (1991), editor C. SOMBRET.
26. J.P. MONCOUYOUX and C. SOMBRET, *French High-Level Waste Management Research and Development Program*, International High-Level Radioactive Waste Management Conference, Las Vegas (1992).
27. P. LEROY and N. JACQUET-FRANCILLON, *HLW Immobilization in Glass: Industrial Operation*, International High-Level Radioactive Waste Management Conference, Las Vegas (1992).
28. R. BONNIAUD, "Survey of the Studies Conducted in France on the Solidification of Concentrated Fission Product Solutions", *Proceedings of the Symposium on Solidification and Long-Term Storage of Highly Radioactive Wastes*, Richland, Washington, pp. 222-333 (1966).
29. R. BONNIAUD, C. SOMBRET and A. JOUAN, "Large-Scale Waste Glass Production", *Proceedings of the Symposium on High-Level Radioactive Solid Waste Forms*, Denver, pp. 155-197 (1978).
30. J.P. MONCOUYOUX, P. HUGONY and A. PIERAGGI, "L'Atelier de vitrification de Marcoule: Trente mois de fonctionnement", *Proceedings of the International Seminar on Chemistry and Process Engineering for High-Level Liquid Waste Solidification*, Jülich, Germany, p. 12 (1981).
31. A. JOUAN, P. HUGONY and J. MAILLET, "The Vitrification Plants in France", *Proceedings of the American Nuclear Society International Topical Meeting on Waste Management, Decontamination and Decommissioning (SPECTRUM '86)*, Niagara Falls, p. 699 (1986).
32. J. MAILLET and C. SOMBRET, *Vitrification of High-Level Wastes: French Experience*, IAEA International Conference on Nuclear Power Performance and Safety, Vienna (1987).
33. C. SOMBRET, *Vitrification of High-Level Wastes in France*, 11th Annual Energy Conference, Knoxville (1984).
34. C. SOMBRET, *Vitrification Experience and Projects in France*, International Meeting on Fuel Reprocessing and Waste Management, Jackson, Wyoming (1984).
35. J.P. MONCOUYOUX, A. JOUAN and C. SOMBRET, *Present Status of the French Continuous Fission Product Vitrification Process*, Third International Symposium on Nuclear Waste Management, 88th Annual Meeting of the American Ceramic Society, Chicago (1986).
36. M. ALLES and M. LUNG, *High Activity Waste Conditioning Vitrification Process: French Experience*, Conference on Nuclear Power and China, Beijing (1986).
37. S. MERLIN, *The La Hague Vitrification Facilities*, Waste Management '86, Tucson (1986).

BNS/OECD-NEA Symposium on the  
SAFETY OF THE NUCLEAR FUEL CYCLE  
Brussels, 3-4 June 1993

**SAFETY IN THE DESIGN AND OPERATION  
OF THE VITRIFICATION FACILITIES AT LA HAGUE**

D. MARTINEAU

Commissariat à l'Energie Atomique  
Institut de Protection et de Sécurité Nucléaire  
Fontenay-aux-Roses, France

**ABSTRACT**

This paper presents the general methodology applied to the safety analysis of the vitrification facilities "R7" and "T7" at la Hague site and the first operating results in the safety field.

**RESUME**

Ce document présente la méthodologie générale appliquée à l'étude de sûreté des ateliers de vitrification "R7" et "T7" du site de la Hague et les premiers résultats d'exploitation dans le domaine de la sûreté.

## 1) INTRODUCTION

Highly radioactive liquids arising from reprocessing operations at COGEMA La Hague plant have been stored in large stainless steel tanks since 1965. The vitrification plant converts these liquids into a more stable solid form. It represents a major advance in the safety of storage of high level waste.

Vitrification of high-level waste has now entered an industrial phase at La Hague with R7 and T7 facilities.

R7 active operations began on June 1989. That facility is now vitrifying the backlog of fission products resulting from the operation of the existing UP2 reprocessing plant.

T7 active operations began on June 1992. That facility is now vitrifying the fission products solutions resulting from UP3-A reprocessing plant.

This paper presents the general methodology applied to the safety analysis of the vitrification facilities at la Hague site and the first operating safety results.

## 2) SAFETY ANALYSIS

The main priorities are to reduce personnel exposure as low as reasonably achievable (ALARA) and to confine radioactive materials in order to maintain the safety of the staff, the environnement and the public.

These goals have to be reached in normal operating conditions and also in accidental situations.

Safety requirements are defined by safety analyses or by applying general safety rules such as redundancy and multibarrier concept. In some cases, a probabilistic analysis method is used to determine the safety requirements.

## 3) SAFETY RULES FOR NORMAL OPERATING

For normal operating, the analysis of the La Hague vitrification plant leads to specify the main safety rules

- In the storage tanks, the temperature of solutions of fission products must be maintained below the limit of 60°C (140 °F).



- The concentration of hydrogen in the tank atmospheres, produced by radiolysis in fission products solutions, must be maintained below the limit of 2 % in volume.
- The vitrified wastes must be prepared in compliance with specifications approved by safety authorities.
- The thermal energy of the containers must be evacuated by air-cooling in such a way that the glass temperature must be maintained below the limit of 510°C (950 °F) (100°C below the low crystallization temperature).
- The thermal energy of the containers must be evacuated by air-cooling in such a way that the average temperature of the concrete must be maintained below the limit of 90°C (194°F).
- The storage of vitrified waste is not a definitive one, the containers must be stored in such a way that they can later be taken up again and carried away.
- The non fixed surface contamination of filled vitrified product containers must be maintained below the limit of 3.7 Bq/cm<sup>2</sup>.

#### 4) **ABNORMAL OPERATING CONDITIONS AND ANTICIPATED ACCIDENTS**

For the vitrification plant the most significant accidents are the following

- Failure of high activity liquid waste cooling systems.
- Loss of air dilution of radiolytic hydrogen
- Loss of cooling of the vitrified waste storage
- Fall of a heavy load (container) in the vitrified waste storage
- Flooding of the building from external origin
- Extreme weather conditions

- Aircraft-crash
- Fire
- Earthquake

#### **4-1) Failure of high activity liquid waste cooling systems.**

In the event of a failure of the cooling system, self heat generation would be sufficient to reach boiling conditions in several hours. Volatile fission products might possibly be partly released to the atmosphere. The system has been designed to reduce the probability of occurrence of such an accident by redundancy of the cooling system and electricity supplies.

For example, the electricity supply of the pumps of the "water cooling system" is made up of 3 levels :

- grid supply,
- emergency diesel generators,
- ultimate emergency diesel generators, which are designed so as to withstand earthquake.

In this situation the annual probability of a total loss of the cooling system of fission products solutions during several hours, is lower than  $10^{-7}$ .

In the event of a failure of the cooling systems, a supply of sufficient volumes of cooling water could be arranged to prevent the solution boiling off.

#### **4-2) Loss of air dilution of radiolytic hydrogen**

The prevention of explosion hazard caused by the accumulation of hydrogen produced by radiolysis is based on the dilution of the tank atmosphere with air.

The system has been designed to reduce the probability of occurrence of such an accident.

The air necessary for flushing is produced by two passive redundant booster pumps. The electricity supply of the pumps is also made up of 3 levels.

In the event of unavailability of the two booster pumps, it is possible to supply the distribution header directly with the industrial compressed air of the plant.

#### **4-3) Loss of the electrical power supplies of the cooling system of the vitrified wastes storage**

In the event of total loss of the electrical power supplies of the site, the containers are cooled by natural convection.

Triggering of the ventilation dampers allowing the change from normal ventilation to natural draft is automatic. These dampers are moved by their own weight in this case (they can also be operated manually).

#### **4-4) Dropping of loads (container) in the vitrification waste storage**

The reliability studies indicate that the annual probability of dropping of a container in the interim storage facility is less than  $10^{-7}$ .

Furthermore, container drop tests have been carried out. These tests have made it possible to demonstrate, thanks to the shock absorbers installed at the bottoms of the wells, the possibility of picking up a container after a fall.

#### **4-5) Flooding of external origin to the building**

This risk is allowed for as follows :

- leaktightness of the building is ensured by suitable coatings,
- land drains equipped with pumps are installed around building.

#### **4-6) Extreme weather conditions**

The highest winds, in accordance with the French "snow and wind" regulations, have been taken into consideration, particularly for establishing the design basis of the interim storage facility stack.

Anti-icing devices protect the ventilation air intake ; the electrical power supply of these devices is made up of three levels.

(The stack well supported the last severe wind during October 1987 tempest, the speed of the wind was higher than 210 km/130 miles per hour).

#### 4-7) Aircraft Crash

In view of the way in which air space is organized, the nature of flights and the existing statistics, it is possible to calculate the probability per square meter of the fall of a reference aircraft for a given site.

For the La Hague site :

- the annual probability of a fall per square meter is about  $4.4 \cdot 10^{-11}$ .
- the reference aircraft is a CESSNA - type light plane.

The tests carried out by the Centre d'Etudes Scientifiques et Techniques d'Aquitaine (CESTA) have demonstrated that 50 cm of concrete representative of workshop walls constitute an effective shield for the reference missile.

In vitrification plant, the storage itself is protected by the concrete of the building whose thickness is superior to 50 cm.

The other buildings are targets whose annual probability that an aircraft crashes on a sensible point is lower than  $10^{-7}$ . Therefore, the accident air-craft crash on these buildings, is considered beyond design.

#### 4-8) Fire

The analysis leads to the designation and installation of fireproof walls and doors, fire detectors and fire-fighting systems, particularly in all rooms with high surface heat potential. This involved nearly all the electrical and electronics rooms.

To prevent common mode failure in case of fire, supply networks for electrical power and important fluids are doubled and physically separated.

#### 4-9) Earthquake

The earthquake taken into account in the plant design has an intensity VIII on M.S.K scale.

Allowance for the seismic risk essentially leads to design the following equipment to withstand earthquake :

- the civil works structures,
- the tanks of fission products solutions,
- the system of cooling the solutions of fission products,
- the system of air-dilution of the hydrogen product by radiolysis,
- the structure of the wells in which the containers are held,
- the equipment and structures which contribute to the cooling by natural convection of the vitrified wastes storage (inlet and outlet circuits, ventilation dampers, anti-icing system...),
- the ultimate emergency diesel generators and their electrical circuits to the equipment.

## 5) OPERATING SAFETY

The operating organization in order to maintain safety of the plant is defined in operating procedures and general operating rules.

In normal operating conditions, provisions are made to guarantee the safety rules.

In accidental situation, such as total loss of electrical power or centralized control system, functions important for safety are operated from emergency control rooms, where electric power is supplied by diesel generators.

These operations are performed and checked in compliance with the emergency operating instructions, which provide the operating sequence. Great care was taken to write these emergency operating instructions in simple, precise language, and to include sketches and colour plates for the use of the operators. Drills about these emergency operating instructions are conducted periodically.

## 6) OPERATING SAFETY RESULTS OF THE R7 UNIT VITRIFICATION AT LA HAGUE

- The first active run began on June 1989. By January 1993, 1280 m<sup>3</sup> of fission product solution had been vitrified and 1432 canisters filled, corresponding to a total activity of 18.5 10<sup>6</sup> TBq (500 10<sup>6</sup> Ci).

- The ability of the process to produce glass in compliance with specifications, approved by safety authorities, has been demonstrated.
- In 1991, the average radiation exposure, of the operating staff is 1.19 mSv (the operators whose radiation exposure is 0 mSv are removed).  
In 1992, the average radiation exposure, of the operating staff is 0.42 mSv (the operators whose radiation dose is 0 mSv are removed).
- The level of gaseous radioactive discharge of the vitrification plant R7, in 1990, 1991 or 1992, represents a very low percentage of the level authorized for the la Hague site.

There is no measurable radioactivity in the product store cooling air which can be attributed to the storage of radioactive containers.

#### 7) OPERATING SAFETY RESULTS OF THE T7 UNIT VITRIFICATION AT LA HAGUE

- The first active run began on june 1992. By january 1993, 144 canisters had been filled corresponding to a total activity of  $2.2 \cdot 10^9$  TBq ( $60 \cdot 10^9$  Ci).
- The ability of the process to produce glass in compliance with specifications approved by safety authorities, has been demonstrated. In T7 unit the suspensions of clarification fines of the fuel dissolution liquors are vitrified.
- In 1992, the average radiation exposure of the operating staff is 0.85 mSv (the operators whose radiation exposure is 0 mSv are removed).
- There is no measurable radioactivity in the product store cooling air which can be attributed to the storage of active containers.

#### 8) CONCLUSIONS

After three years of active operation of the La Hague vitrification plant, the following results have been obtained:

- The process is able to produce glass in compliance with specifications approved by safety authorities.
- The level of discharge of gaseous radioactive effluents of the vitrification plant is very low.
- The average radiation exposure of the operating staff is lower than 1.2 mSv (zero doses removed).

## 9) BIBLIOGRAPHIC REFERENCES

- [1] JP. Mercier, F. Bonneval, M. Weber (IPSN), "Application of probabilistic approach to UP3-A reprocessing plant". Proceedings OECD/NEA/CSNI/ Specialist Meeting on Safety and risk assessment in fuel cycle facilities. October, 1991, Tokyo, Japan.
- [2] A. Denys, F. Justin, JJ. Lavigne, (SGN), G. Dubois, W. Fournier, (COGEMA). "Safety in the design and operation of the new UP3 reprocessing plant at la Hague". Proceedings OECD/NEA/CSNI/ Specialist Meeting on Safety and risk assessment in fuel cycle facilities. October, 1991, Tokyo, Japan.
- [3] W. Fournier, D. Alexandre, P. Leroy and P. Hugony, (COGEMA), C. Sombret and A. Jouan (CEA), C. Bernard, (SGN). "Start-up of Commercial high-level waste vitrification facilities at La Hague", Proceedings RECOD april 1991, -Sendai, Japan - Vol. L p.278-282.

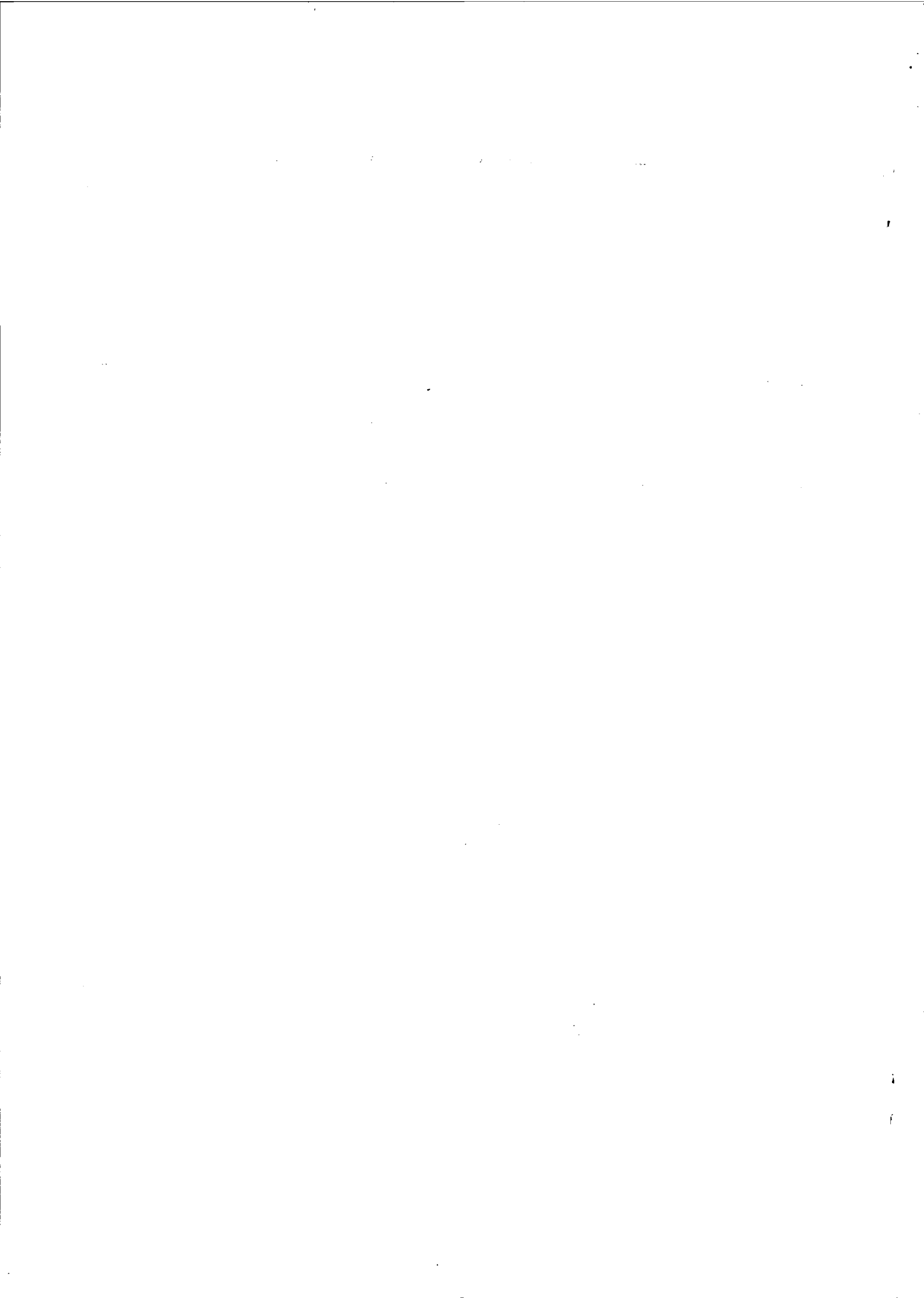



June 3, 1993

O/Ref. 93-1058/PDG/cb  
Class. XGBNØØ

**B N S ANNUAL MEETING**

**"SAFETY OF THE NUCLEAR FUEL CYCLE"**

**Brussels, June 3-4, 1993.**

**LIST OF PARTICIPANTS**

NAME	COMPANY/ORGANISATION
AGOSTINI J.P.	CEA/DCC/DPE
ANCKAERT E.	ABB Energie
AUCHERE H.	CEA/IPSN/DES
BAETSLE L.	SCK/CEN
BAIRIOT H.	FEX
BALLAUX C.	AV Controlatom
BAUGNET J.M.	CEN/SCK
BERNHARDT S.	COGEMA
BESANCON J.	COGEMA
BINDLER L.	BELGONUCLEAIRE
BLANKENVOORDE P.	ECN Petten
BOERMANS P.	FBFC International
BONET H.	Siemens AG (KWU-B)
BRESTRICH I.	TUV-Südwest
BRONS J.	
BROWN M.	AEA/SRD (Culham)
BRULS R.	Siemens
BRAHLER G.	Siemens
CHARLES T.	IPSN/DES
CHOMETON P.	COGEMA
CLAES J.	BELGOPROCESS
COLLARD G.	SCK/CEN
CORNET G.	BELGONUCLEAIRE
D'OLIESLAGER W.	KUL
DARBOURET B.	IPSN/DES
DE BATIST R.	RUCA
DEKKER G.G.	URENCO
DELHOVE J.	AV Controlatom
DERAMAIX P.	BELGONUCLEAIRE
DE REGGE P.	SCK/CEN
DE TURENNE C.	COGEMA
ECKHOUT F.	BELGONUCLEAIRE
EVANS R.	BNFL Sellafield
FERRARI P.	BELGOPROCESS
FIERENS L.	COMPRIMO België
GAUBE M.	BELGATOM
GELPKE K.	Bundesamt Strahlenschutz
GERARD J.	FBFC International
GILLET B.	COGEMA

GILLON L.	UCL
GLATTES G.	Uranerzbergbau GmbH
GOLDSCHMIDT P.	SYNATOM
GOVAERTS Paul	SCK/CEN
GOVAERTS Pierre	AIB-Vinçotte Nuclear
HOLMSTOCK L.	SCK/CEN
HUGON M.	CEC/DG XII
IVENS R.	BNFL Brussels
KANAMORI M.	Power Reactor & Nucl. Fuel Development.
KATAYAMA K.	Japanese Government/Sc.& Tech. Ag.
KAUFER B.	OECD/NEA
LEFEVRE J.	CEA/DCC
LEONARD F.	
LIBOTTE P.	Ministère de l'Emploi et du Travail
LUNG M.	FORATOM
MAKI N.	OECD/NEA
MARTINEAU D.	CEA/IPSN
MATHIEU Ph.	Université de Liège
MERCIER J.P.	CEA/IPSN
MINON J.P.	ONDRAF/NIRAS
MORELLE J.	UCL/KUL/Ministry Economic Affairs
MULLINEAUX W.	British Nuclear Fuels
MUND E.	ULB
NAITO Y.	JAERI
NOCKENBERG B.	OKO-Institut
OI N.	IAEA
OLIVEIRA NETO J.	IPEN-CNEN/SP
POTDEVIN H.	FBFC International
PYPE J.	SYNATOM
RECIO F.	ENUSA
REMACLE J.	Ministère des Affaires Economiques
RENARD A.	BELGONUCLEAIRE
ROBEYNS G.	BELGONUCLEAIRE
ROCH M.	TRACTEBEL
ROSENGARD A.	CEA/DCC/DPE
SANTIAGO J.L.	ENRESA
SHEPPARD G.	British Nuclear Fuels
SIMON R.	CEC
SIMONNET J.	COGEMA
SMISSAERT G.	TRACTEBEL
SOMBRET C.	CEA/DPR
STADIE K.	OECD-NEA

STEVENS G.	OECD/NEA
TEW M.	NII
THOMAS W.	GRS
VAN BOSSTRAETEN C.	CORAPRO
VAN DENHOVE P.	FBFC International
VAN GEEL J.	CEC - JRC Karlsruhe
VAN RIJ H.	ECN
VAN VLIET J.	BELGONUCLEAIRE
VANDEN BEMDEN E.	FEX SA
VANDERGHEYNST A.	BELGONUCLEAIRE
VANDORPE M.	TRANSNUBEL
VERECKEN J.	VUB/Metallurgy
VIGLASKY T.	AECB
WILLIAMS L.	NII
ZACCAI H.	ONDRAF/NIRAS